

The Medical NBC BATTLEBOOK

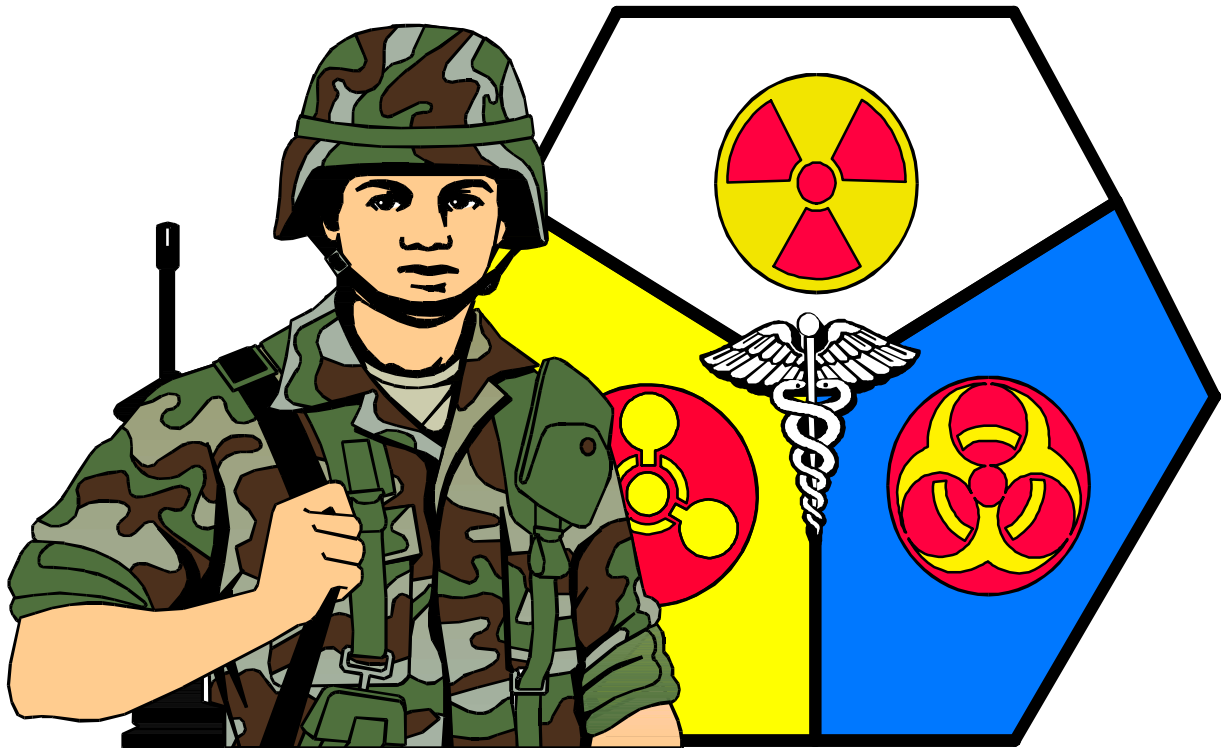

USACHPPM Tech Guide 244



USACHPPM
Readiness thru Health

DISTRIBUTION: Approved for public release; distribution unlimited.

DESTRUCTION NOTICE: Destroy by any method that will prevent disclosure of contents or reconstruction of the document.

May 2000

THE MEDICAL NBC BATTLEBOOK

"I also worried about the great empty area of southern Iraq where the Army would launch its attack. I kept asking myself, 'What does Saddam know about that flank that I don't? Why doesn't he have any forces out there?' The intelligence people suggested offhandedly, 'Maybe he plans to pop a nuke out there.' They then nicknamed the sector the 'chemical killing sack.' I'd flinch every time I heard it. I had a nightmare vision of Fred Franks and Gary Luck hitting that area only to have the Iraqis dump massive quantities of chemicals while the Republican Guard counterattacked and fought us to a stalemate. I became increasingly jumpy."

General H. Norman Schwarzkopf, 1991

This page left intentionally blank.

ACKNOWLEDGMENTS

The Battlebook Project Team at The U.S. Army Center for Health Promotion and Preventive Medicine (USACHPPM) would like to thank and acknowledge the following people for their contributions in the development of this battlebook:

Colonel Robert Eng, Armed Forces Radiobiology Research Institute (AFRRI)

Lieutenant Colonel Carl Curling, The Office of the Surgeon General

Lieutenant Colonel William Klenke, 30th Medical Brigade

Mr. Jesse Barkley, The Office of the Deputy for Technical Services, USACHPPM

Lieutenant Colonel Debra Schnelle, Directorate of Occupational Health Science, USACHPPM

Major Gary Matcek, Directorate of Occupational Health Science, USACHPPM

Battlebook Project Team

Dr. C. B. McKee, Directorate of Occupational Health Science, USACHPPM

Dr. Lisa Collins, Oak Ridge Institute of Science and Engineering

Ms Jennifer Keetley, Directorate of Environmental Health Engineering

Dr. Howard Bausum, Office of the Deputy of Technical Services

Major Terry Besch, Directorate of Toxicology

Captain Craig Moss, MEDDAC - Ft Leonard Wood

First Lieutenant Francis Hoin, Directorate of Occupational Health Science

Various other personnel from USACHPPM

PREFACE

Purpose and Scope

The purpose of this battlebook is to address operational health concerns in environments where Nuclear, Biological, and Chemical (NBC) threats exist. Potential NBC threats range from weapons of mass destruction to contamination of the battlefield by hazardous material. Medical personnel, in conjunction with chemical personnel, must be able to advise commanders on a wide range of issues including the health effects of NBC threats, protective clothing and measures, and management of NBC casualties.

This manual is not an emergency response book or treatment guide. It is intended to provide a quick reference for decision making as to whether to request expert consultation in a given area. Except in extreme emergency, the contents should not be construed as definitive.

Intended Audience

The *Medical NBC Battlebook* is designed for the AMEDD soldiers in the field or training for the field.

Use of Trade Names or Trademarks

The use of trade names or trademarks in this publication are for illustrative purposes only. Their use does not constitute endorsement by the Department of Defense.

User Comments

The proponent of the publication is The Office of the Surgeon General through the Center of Health Promotion and Preventive Medicine. Please forward all recommendations to Commander, CHPPM, ATTN: MHCBS-TS-OMH, APG-EA, MD, 21010-5422.

Gender Statement

Unless this publication states otherwise, masculine nouns and pronouns do not refer exclusively to men.

TABLE OF CONTENTS

CHAPTER 1 _____ GENERAL OPERATIONAL ASPECTS

CHAPTER 2 _____ NUCLEAR WEAPONS

CHAPTER 3 _____ RADIOLOGICAL HAZARDS

CHAPTER 4 _____ BIOLOGICAL

CHAPTER 5 _____ CHEMICAL

CHAPTER 6 _____ LASERS AND RADIOFREQUENCY

CHAPTER 7 _____ EQUIPMENT

CHAPTER 8 _____ POINTS OF CONTACTS

APPENDIX A _____ GLOSSARY OF TERMS AND ACRONYMS

APPENDIX B _____ REFERENCES

APPENDIX C _____ INDEX

1 GENERAL OPERATIONAL ASPECTS

Table of Contents

1.1.	Introduction _____	1-2
1.2.	Threats _____	1-2
1.3.	The Range of Military Operations _____	1-3
1.4.	Units of Special Consideration for Medical NBC Operations _____	1-3
1.5.	Sources of Intelligence _____	1-5
1.6.	Pre-deployment _____	1-7
1.7.	Deployment _____	1-8
1.8.	General Operational Guidance in NBC Conditions _____	1-11
1.9.	Protection _____	1-12
1.10.	Decontamination _____	1-14
1.11.	Medical Evacuation and Decision Process _____	1-17

List of Tables

Table 1-A:	Industrial and Environmental Threats to the Deployed Force _____	1-6
Table 1-B:	Required Site Information _____	1-6
Table 1-C:	MOPP Levels for Soldiers Not in Collective-Protection _____	1-13
Table 1-D:	MOPP Levels for Soldiers in Collective-Protection _____	1-14
Table 1-E:	Equipment Needed to Decontaminate a Company _____	1-15
Table 1-F:	Personnel Decontamination Lane _____	1-16

List of Figures

Figure 1-A:	Layout for a patient decontamination station _____	1-16
-------------	--	------

1.1. Introduction

1. References for Chapter One: FM 3-6, FM 3-7, FM 3-100, FM 8-10-7, FM 8-10-8, FM 8-10-17 (Draft), FM 8-42, FM 8-285, FM 100-5, FM 101-5, STP 21-1-SMCT, and TC 3-10.
2. The US Army conducts operations in areas where potential adversaries could use NBC weapons. These weapons range from a megaton nuclear weapon used to destroy an entire city to a barrel of industrial chemicals used to contaminate an important road intersection. In addition to their destructive power, NBC weapons have political, psychological, operational, and strategic impact. The use of passive measures such as proactive NBC defense procedures is a potential tool to reduce the threat of NBC weapons. In the event of the use of NBC weapons, the medical personnel must be prepared to provide a variety of services including medical treatment, site hazard surveys, and medical hazard assessments.

1.2. Threats

1. Nuclear Weapons. Although the threat of global nuclear annihilation has diminished, Russia and China still maintain large numbers of nuclear weapons. While direct confrontation with these nations is not likely at the present time, medical units must still be prepared for such conflicts. Several potential adversaries such as North Korea, Iraq, and Iran have tried to develop nuclear weapons. These countries could use nuclear weapons either to gain a tactical advantage or as a terrorist weapon. The employment of nuclear weapons in stability and support operations such as Bosnia is not likely; however, commanders must be prepared for their use. With the advent of new technologies, it is conceivable that a terrorist or terrorist organization could obtain a small nuclear device. This device could then be used to hold a city or state at ransom. The employment of nuclear weapons could rapidly escalate a stability and support operational scenario into a major war.
2. Radiological Hazards. Adversaries and even terrorists could spread radioactive material in an effort to deny US forces access to key terrain, roads, and buildings. The use of radiation dispersal devices and destruction of local nuclear reactors by terrorists are examples of radiological threats. Other radiological hazards present during deployments may include improperly dumped waste and accidents involving radioactive commodities.
3. Biological Warfare. Biological warfare agents range in spectrum from sophisticated, specifically engineered infectious microorganisms and toxins produced in modern biotechnology laboratories, to simple expedient food contaminants employed by insurgents or terrorists. Health care personnel must be alert to any increase in infectious disease rates or disease cases not commonly found in the area of operations. Because the use of biological weapons is not always initially evident and symptoms may take days to weeks to appear, epidemiology may provide the first clue to an attack.
4. Chemical Warfare Agents. Chemical agents are relatively simple to make and employ. Since their effects are immediate and dramatic, chemical weapons are used to kill and injure and also for terrain denial for persistent agents. For example, Iraq used large quantities of blister agents in its war against Iran. Although not classed as chemical warfare agents, incendiary/flame munitions, phosphorus compounds, and irritants O-chlorobenzylidene (CS) and chloroacetophenone (CN)

could be encountered by US forces in stability and support operations. Industrial chemicals, either by accidents or intentional dispersion by adversaries, also pose possible threats to US forces. In order to predict potentially hazardous situations, treat casualties, and decontaminate areas and personnel, US forces should be aware of the industrial chemical hazards in their area. Toxic industrial chemicals (TICs) and radioactive material are collectively referred to as toxic industrial materials (TIMs).

5. **Lasers and Radiofrequency Hazards.** The threat of laser injuries on the battlefield is both real and significant. Lasers of many types, powers, and wavelength characteristics have been integrated into and are used by most force structures of the world. While the US and many other countries prohibit the use of lasers specifically designed to cause permanent blindness, the threat from such weapons must be considered. While the main symptom of laser injury is reduction in visual acuity, they may also be used to dazzle or startle. The US and many other countries currently use lasers as range finders and target designators. These sources, as well as radiofrequency sources used in communications, target detection, and a multiple of other uses, present occupational health hazards if used improperly.

1.3. The Range of Military Operations

The US seeks to achieve its strategic objectives in three diverse environments: peacetime, conflict, and war. The Army classifies its activities during peacetime and conflict as operations other than war. Some operations such as Joint Endeavor in Bosnia are also referred to as support and stability operations. During peacetime and conflict, possible NBC threats include terrorist use of biological weapons or covert release of toxic industrial materials. During war, nuclear and chemical weapons are also possible NBC threats.

1.4. Units of Special Consideration for Medical NBC Operations

1. **General.** This section briefly discusses some of the possible units that would be involved in the medical NBC aspects of operations. Each operation will have a unique combination of these units, therefore prior coordination before deployment is suggested.
2. **Intelligence - S2/G2.** The S2/G2 section gathers and prepares intelligence about the enemy and the terrain. When preparing for deployment, commanders can obtain information on the types of endemic diseases in the area, the biological and chemical agent potential, and other medical threats. Additionally, once deployed, the S2/G2 maintains records regarding NBC use and potential use in the theater. With this information, the commander can brief his troops to enable them to recognize signs and symptoms of possible biological agent use, or endemic disease outbreaks. The commander can also ensure that his troops are either in MOPP or prepared to assume a MOPP when necessary. To determine the relative safety of his facility, the commander directs his S2/G2 to conduct a vulnerability analysis of their position. The S2/G2 produces intelligence information about the enemy's NBC equipment and activity; he provides a detailed characteristics review of an area. Weather and terrain information, coupled with the enemy's NBC equipment and doctrine, result in an understanding of whether the environmental factors are conducive to employment of NBC weapons. The S2/S3 coordinates with the supported units to determine the casualty estimates. NBC threat assessments require coordination with the unit NBC officer or NCO.

3. Civil - Military Affairs - S5/G5. The S5/G5 section may be able to provide or locate information about industrial operations in the area of concern. The S5/G5 may require technical expertise for the risk communications with the local populous if they believe that the US military has contaminated their area. The risk communications program at Center for Health Promotion and Preventive Medicine (USACHPPM) can provide support.
4. Chemical Units. Chemical units can provide assistance with decontamination of personnel and equipment. Special NBC surveillance units consisting of BIDS and FOX vehicles can provide early warning of chemical and biological attacks. The Technical Escort units usually handle the transportation of samples of suspected NBC agents.
5. Ordnance and Supply Units. Explosive Ordnance Detachments normally handle or coordinate the removal of all unexploded ordnance. The Industrial Operations Command (IOC) assists in the removal, storage and processing of equipment from the battlefield. Preventive medicine units need to coordinate with both the maintenance companies and IOC to ensure proper health physics practices. The Army Materiel Command (AMC) is the Nuclear Regulatory Commission (NRC) license's holder for most of the radioactive items in the field.
6. Engineer Units. Engineer units can assist in the construction of decontamination pits and possibly provide information about local industrial and environmental hazards.
7. Special Operations. Special Forces present unique medical NBC challenges. During operations deep in the enemy's rear area, the Special Forces units may encounter NBC agents from several sources. For example, the US forces may strike against the enemy's storage and production sites of NBC weapons releasing hazardous agent. Covert units operating near those areas may be exposed to the agent. Since the special forces units operate in the enemy's rear area, these forces cannot expect usual Army Medical Department (AMEDD) support in terms of evacuation and hospitalization, so they will probably be responsible for their own NBC medical support for an extended period of time.
8. Medical Units. The FM 8-10 series fully describes medical operations during deployment. Refer to these manuals for the mission and capabilities of the Theater Army Surgeon, Medical Command, and subordinate units.
9. Special Medical Units.
 - A. Theater Army Medical Laboratory (TAML). TAML's mission is to identify and evaluate health hazard in an area of operations by using laboratory analyses and rapid health hazard assessment of nuclear, radiological, biological, chemical, endemic disease, environmental and occupations health threats.
 - B. Preventive Medicine Detachment. This detachment provides technical consultation support on preventive medicine issues throughout its area of responsibility. The unit provides specialized support in the areas of disease and non-battle injuries (DNBI) surveillance, health physics, disease vector identification, environmental engineering, health threat profile, and health hazard assessment. Its medical NBC capabilities may include but are not limited to:
 - (1) Collecting water and ice samples for NBC surveillance.
 - (2) Establishing and maintaining chain of custody for samples, and forwarding samples to supporting laboratory for identification.

(3) Coordinating with NBC reconnaissance and biological detection units for the analysis of environmental samples.

1.5. Sources of Intelligence

1. The S2/G2 should be the main source of intelligence for the unit.
2. Armed Forces Medical Intelligence Center (AFMIC) can provide intelligence about the medical, environmental, and industrial threats in the area of concern. The AFMIC Bulletin Board System (BBS) is an automated online system for the dissemination of unclassified medical intelligence products. This system is designed to provide consumers with timely, user friendly access to AFMIC products. AFMIC also produces the MEDIC CD. (See Points of Contact Section).
3. Central Intelligence Agency (CIA) World Factbook - The CIA World Factbook is an unclassified publication that provides general political and economic data on all countries of the world. It is updated annually. In addition to hardcopy publication, it is also available on the CIA home page on both the Internet and INTELINK. There is also a classified supplement that provides information on military, security, and intelligence forces worldwide. The web address is www.odci.gov/cia/publications/factbook/index.html.
4. INTELINK has been described as the "classified on ramp to the information superhighway." All national level intelligence organizations, including AFMIC, have home pages on INTELINK. All AFMIC products are placed on INTELINK. In addition, each Unified Command Joint Intelligence Center has a home page. Within the Intelligence Community, INTELINK rapidly is becoming the preferred method of dissemination. Many recent intelligence publications are found on the INTELINK. If preferred, INTELINK has a print capability. The Central Intelligence Agency has a home page where users may access the World Factbook. The State Department home page contains State Department Country Fact Sheets, Embassy information, and travel advisories.
5. Other commercial databases are available that address areas of interest to medical planners, such as travel medicine.
6. Environmental and Industrial Threats.
 - A. The intelligence community, to include the AFMIC, CIA, and DIA (Defense Intelligence Agency) has taken measures to produce intelligence products geared toward environmental threats (both potential and actual) that can impact US Forces. Several actual and potential environmental threats imposed on US Forces have demonstrated the necessity of this type of information. Past and present environmental and industrial threats include the Kuwait Oil Well Fires, the destruction of a chemical weapon depot near Khamisiyah in Iraq, and the localized contamination of air and soil from hazardous waste sites in Bosnia-Herzegovina during Operation Joint Endeavor. The intelligence community has begun to investigate and archive information on pertinent environmental threats to include those from toxic industrial chemicals (TICs), chemical and biological weapons, and radiological sources.
 - B. Sources of Intelligence. Intelligence about environmental and industrial hazards should be requested through the standard channels for intelligence. Being as specific as possible when requesting information through the intelligence channel allows the intelligence analyst to obtain the appropriate data. Additional information may be gathered through the S5/G5. They may be

able to gather local information about industrial and other sites. A review of local environmental protection laws and their implementation may provide useful information in determining possible hazards from industrial pollutants and waste. The web can offer additional information. For example, three web sites that list the nuclear reactors in the world can be found in Chapter 3.

C. Possible Threats. The sources of environmental and industrial hazards may be quite extensive if the operation is in an industrialized area. Any site that stores or uses toxic material may pose a threat to US service members even if the site is operating under normal conditions. Industrial sabotages, such as, destruction of a large industrial complex could release potentially toxic substances. Possible sites prone to threat include hospitals, mines, and manufacturing facilities. Table 1-A summarizes the typical industrial and environmental threats that a deployed U.S. Force may encounter with respect to site characteristics.

D. Threat Information. For each of these threats and site types, several items are required to complete an environmental threat assessment. Since the pertinent site information is normally classified, secure communications may be needed.

Table 1-A: Industrial and Environmental Threats to the Deployed Force

Environmental Threat	Type of Site
Toxic Industrial Chemicals	Manufacturing sites, oil refineries, chemical productions facilities, Universities and colleges, hospitals, storage tanks, waste dumps
Chemical/Biological Weapons	Manufacturing and storage and disposal sites
Radiological hazards	Nuclear power plants and refinery sites, nuclear weapons plants, storage areas, hospitals, Universities and colleges
All hazards	Railroads and major roads

Table 1-B: Required Site Information

Site Information	Comment
Geographic Location	Latitude/Longitude; Surrounding Environment including population
Background	Type and History of Facility
Equipment Maintenance	Has equipment been maintained and at what level
Stored or Manufactured Chemicals	Type(s) of Chemicals (i.e., chlorines, etc.)
Amount/Quantity of Stored Chemical(s)	Pounds or Tons; actual or estimated; specific emission inventory data
Type of Weapons, Munitions	Size, payload, quantity, agent purity
Background Pollutant Levels	Overall pollution levels in Region

1.6. Pre-deployment

1. NBC Common Skills Tasks. All service members, including medical personnel, must be extremely proficient at the NBC common skill tasks. These tasks are given in STP 21-1-SMCT, Soldier's Manual of Common Tasks: Skill Level 1. These tasks include putting on the protective mask, donning MOPP level, first aid, and buddy aid. The first aid task is ADMINISTER NERVE AGENT ANTIDOTE TO SELF (SELF-AID), task number 081-831-1030. The buddy aid task is ADMINISTER FIRST AID TO A NERVE AGENT CASUALTY (BUDDY-AID), task number 081-831-1031. **Actions taken during first aid, buddy aid and decontamination predominantly determine the extent of the injury and the probability of survival for casualties from chemical weapons.** This is one of the most important concepts in this entire handbook. This fact is not understood or accepted by soldiers or leaders. In general, decontamination must be done very quickly after a lethal dose is delivered.
2. Suggested training courses for individuals (see Points of Contacts chapter for phone numbers for the various organizations):
 - A. Medical Management of Chemical and Biological Casualties Course. Offered jointly by U.S. Army Medical Research Institute of Chemical Defense (USAMRICD) and U.S. Army Medical Research Institute of Infectious Diseases (USAMRIID).
 - B. Medical Effects of Ionizing Radiation (MEIR). Offered by Armed Forces Radiobiology Research Institute (AFRRI).
 - C. Hazard Material Training (HAZMAT). Offered by various organizations including USACHPPM.
 - D. Laser and Radiofrequency Radiation Hazards. Offered by USACHPPM.
 - E. Nuclear Hazards Training Course. Offered by Defense Special Weapons Agency.
 - F. NBC PROFIS Course. Offered by NBC Office, AMEDD Center and School.
3. Suggested References to take on a deployment: FM 3-5, FM 3-7, FM 8-9, JP 3-11 (Draft), USAMRICD's *Medical Management of Chemical Casualties*, and USAMRIID's *Medical Management of Biological Casualties*. The AMEDD NBC Science Branch has a 3 CD set of references.
4. Individual. All service members should know the mission of their unit and determine their role in the unit. Reviewing the Army Training and Evaluation (ARTEP) of the unit is a good source of this information. In addition to tactical information, individuals must also be aware of the current technical and doctrinal information available through reviewing the appropriate references. For example, medical personnel concerned with radiological hazards should review the latest version of the NATO ACE Directive 80-63 if appropriate.
5. Unit. All units need to exercise their NBC capabilities. Depending on the mission of the unit, this training could include sample collection and management of suspected NBC agents, casualty decontamination and treatment, preventive medicine practices, and hazard assessments. Units need to determine and contact possible supporting and supported units. Contact should be made before deployment to allow for smoother operations.

1.7. Deployment

1. The section uses the outline of an operations order: Situation, Mission, Execution, Service Support, and Command and Signal.
2. SITUATION.
 - A. Overall Situation. Determine overall situation including the type of military operation such as peacekeeping, conflict, or war.
 - B. Threats. Determine the threat to US forces including that from terrorism and possible industrial hazards. Needed information includes NBC threats, Conventional threats, and Industrial and environment threats.
 - C. Friendly Forces. Determine the mission of your unit including your higher command, supporting units, and supported unit. Determine the other medical assets in the area of operations.
 - D. Climate and terrain. The climate and terrain of the area of concern may provide help in determining possible threats to troops.
 - (1) Heat stress. Refer to FM 3-7 for information on heat stress in MOPP levels.
 - (2) Weather affects on NBC Agents. Since the weather affects many NBC agents, some conditions favor the selection of one agent over another. For example, mustard will persist in a colder climate for a much longer period than it would in a jungle environment. The following are the weather conditions given in FM 3-7.
 - (a) Inversion Temperature Gradient. This condition usually exists on a clear or partially clear night when middle and low clouds cover less than 30 percent of the sky, and on early mornings until about 1 hour after sunrise when the wind speed is less than 5 km/h--ideal for enemy employment of chemical agents.
 - (b) Neutral Temperature Gradient. This condition usually exists on heavily overcast days or nights at 1 or 2 hours before sunset or 1 to 2 hours after sunrise when the middle and low clouds cover more than 30 percent of the sky. Independent of cloud cover and time of day, a neutral condition may also exist when the wind speed is greater than 5 km/h. Additionally, periods of precipitation are normally accompanied by a neutral condition. A neutral temperature gradient is most favorable for enemy use of biological agents.
 - (c) Lapse Temperature Gradient. This condition normally exists on a clear day when the middle and low clouds cover less than 30 percent of the sky and when the wind speed is less than 5 km/h. It is the least favorable condition for the enemy to employ chemical or biological agents. When a lapse condition exists, area coverage without diffusion will be enhanced with a steady low wind speed of 3 to 7 km/h.
 - E. Endemic Diseases. AFMIC can provide information about the endemic diseases in the area of operations. Additionally, information should be obtained about the diseases endemic to each participating country if the mission involves multinational forces.
3. MISSION. The following are possible missions dealing with medical NBC.

A. Casualty Decontamination. Contaminated casualties entering the medical treatment system are decontaminated through a decentralized process. Cross contamination risk to casualties and evacuation and treatment personnel are greatly reduced by earlier removal of gross contamination from casualties. Removal of contaminated clothing and equipment can provide significant hazard reduction to the entire medical/evacuation process. This is initially started through self-aid and buddy-aid procedures. Later, units should further decontaminate the casualty before evacuation. Patient decontamination stations are established at the field medical treatment facilities (MTF) to decontaminate individuals as required (clothing removal and spot skin decontamination) prior to treatment and further evacuation. According to FM 8-285, non-medical members of the supported units man these stations under medical supervision. Medical supervision is required to prevent further injury to the patient and to provide emergency medical treatment during the decontamination process. There are insufficient medical personnel to both decontaminate and treat patients. Medical personnel will be fully employed providing treatment for the patients during and after decontamination by non-medical personnel. Decontamination is accomplished as quickly as possible to facilitate medical treatment, prevent the patient from absorbing additional agent, and reduce the spread of chemical contamination. (For details on patient decontamination, see Appendix C of FM 8-10-7, and Chapter 9 of FM 3-5.)

B. Treat NBC Casualties. Medical treatment facilities should be prepared to treat the wide range of injuries and the possible large number of casualties from NBC weapons.

C. Evacuation. Evacuation of NBC injured casualties entails more than transportation. Since some casualties may be contaminated, the casualty evacuation system must be organized in a way as to minimize the spread of contamination. Since mass casualties may occur, and the number of medical vehicles may be inadequate to meet the increased load, unit commanders need to have contingency plans to supplement medical vehicles for casualty evacuation, or be prepared to retain casualties within their units for longer periods of time.

D. Disease and Non-battle Injury (DNBI) Surveillance and Epidemiology. DNBI is the military method for reporting the number of sickness and injuries. Each medical treatment unit should submit a DNBI report through its chain of command daily. Epidemiologists can use such data to detect food borne illness, naturally occurring outbreaks of infectious diseases, and possible uses of biological agents. While this is valuable to template routine disease trends, this is extremely critical in a biological warfare environment. Therefore, each theater should implement a DNBI collection system and report the data such that it is meaningful to (and for) the senior maneuver and medical commanders.

(1) Systematically gather information to input into an automated surveillance system that will produce real time tactically significant health threat profiles. USACHPPM has developed such a system and can provide assistance.

(2) Provide guidance to the command concerning preventive medicine measures (a medical assessment of the command and the potential impact of DNBI on military operations).

E. Detection of Suspected NBC Agents. It is not always evident when biological, chemical, or radiological weapons have been used. For example, several days will pass between the release of anthrax and the appearance of the first symptom. One method to detect the use of NBC agents before the appearance of symptoms is to sample the environment and troops. Personnel monitoring using radiation survey instruments should be done if radioactive contamination is

suspected. Depending on the units present, several different units may be given the missions of collecting, transporting and analyzing suspected NBC agents. Unit level equipment currently only detects standard chemical warfare agents, and then only at or near the first effects level. Chemical units use the FOX to detect chemical agents and the BIDS to detect biological agents. The FOX vehicle is excellent at detecting and identifying liquid contamination, as long as the hazardous substances are in its mass spectrometer data library. The FOX IS NOT a good hazard detector if only sampling the air. Advanced detectors such as Portal Shield may also be in theater. Preventive medicine units have limited collection and analysis capabilities for both toxic industrial materials and NBC agents. The 520th TAML is capable of detecting very low levels of biological agents, chemical agents, radiological material, and toxic industrial material. Tech Escort units are capable of both the collection and transportation of suspected NBC agents. In addition to units in the area of operations, other military units such as USAMRICD and non-military government organization such as the Centers for Disease Control and Prevention (CDC) also play a role in analyzing NBC identification and detection of suspected NBC agents. The interaction between all these units depend on the exact units present and thus can not be discussed in this document.

F. Medical and Environmental Surveillance. To ensure the health of service members, the US routinely collects data about the environment where troops are located or operate. For example, the 520th TAML collected air, water, and soil samples in Bosnia for analysis by USACHPPM. This data help to identify possible health threats to US forces. Both TAML and preventive medicine units, along with Naval and Air Forces units, usually have this mission. All data collected on the environment and the health of the troops during a deployment should be forwarded to USACHPPM for archival.

G. Health Hazard Assessments. Medical units may be requested to provide health hazard assessments of potential industrial and environmental hazards. For information on risk management, refer to FM 101-15 or request help from USACHPPM.

4. EXECUTION.

A. Sample Management of Suspected NBC Agents and Environmental Samples. Because suspected NBC samples have national security implications, all such samples must follow a chain of custody. Each theater should develop a SOP on sample management to include who is responsible for sample collection, transportation, and analysis. This SOP should be thoroughly developed and trained. The unit should first coordinate with the analysis laboratory for proper shipping instructions. If the sample is a suspected NBC agent, further coordination with a Technical Escort Unit will be necessary to ensure the proper chain of custody.

B. Coordination. Identify and coordinate with supporting and support units. For example, the preventive medicine detachment should coordinate with TAML if environmental samples will be taken and then passed to them for analysis. If it is a multinational mission, identify and contact, if appropriate, the offices in the Allied forces similar to those required within US structure.

5. SERVICE SUPPORT.

A. Personnel and Material Requirements. Software is being developed by the Army Office of the Surgeon General (OTSG) to determine the personnel and material required for the treatment of casualties from NBC weapons.

B. Casualty Decontamination. MTFs must coordinate with surrounding units to provide them with augmentees in case of contaminated casualties.

6. COMMAND AND SIGNAL. The NBC reporting system is detailed in the first Chapter of FM 3-7. All Units should have a copy of this document. JP 3-11 (Draft) includes the new reporting system for toxic industrial material. That material is not included in this document since it is still in draft form.

1.8. General Operational Guidance in NBC Conditions

1. The US Army's general operational guidance for operations in NBC environment is See, Shield, Shape, Move, and Strike. This guidance is detailed in the latest draft of FM 100-5.
2. FMs 8-9, 8-10-4, 8-10-6, 8-10-7, 8-285, and 8-55 contains information for use in planning Health Service Support operations in an NBC environment.
3. Casualty Predictions. NATO publication AMedP-8 gives the casualty predictions for various NBC weapons in tactical situations.
4. Personnel and Medical Unit Requirements. Medical assets must apply NBC protection, detection, and decontamination procedures to maximize and sustain unit capabilities. However, NBC threat conditions may necessitate preparation of medical support to regenerate or reconstitute supported units severely debilitated by NBC attacks. Hospitals should be dispersed away from potential target areas to improve the survivability of these facilities. This mitigation technique, however, cannot be relied upon to prevent significant loss of medical treatment capability. Planning for whole unit replacement must be considered.
5. Medical Readiness. The steps taken before an attack occurs will be the most important in determining how many and how severe the casualties will be. Each area of operations should have established policies on chemoprophylaxis, pre-treatment and vaccines dependent on the threat. These policies should be disseminated to the medical units.
6. Medical Triage. The use of NBC weapons may create a mass casualty situation for the medical treatment facilities. Treatment facilities should review their mass casualty procedures and understand the special implications of NBC weapons. For example, the total radiation dose to a service member from the prompt radiation of a nuclear blast is a factor in determining the triage category of the individual. Medical personnel conducting triage must give special consideration to combined injuries (conventional injuries occurring simultaneously with NBC agent contamination effects). Combined injuries may necessitate lower priority treatments, in mass casualty circumstances, since these injuries together are likely to be significantly more severe than either conventional-only or NBC-only injury cases.
7. Surgical Protection. Surgery of the contaminated wound offers minimal danger to medical and nursing staff if gloves made of butyl rubber are worn. If these are not available then two pairs of latex rubber gloves should suffice if washed at short intervals in hypochlorite solution and changed frequently.
8. Collective Protection. Collective protection provides the capability to medically manage severely toxic or injured decontaminated casualties in an environment where medical personnel are unencumbered by wearing individual protective equipment. Likewise, the casualties benefit from

the capability of the medical unit to make full use of available medical equipment and procedures. A significant percentage of casualties (15-30%) can not be adequately treated in a contaminated environment without collective protection given their treatment requires the removal of their protective mask. If only a vapor hazard exists in the area, it may be feasible to work within that area at less than full individual protection, such as using respiratory and eye protection. Limited medical care can be achieved in this manner, but full examination and definitive surgical treatment is difficult without full collective protection.

9. Coordination with Other Allies.

A. Mutual medical support plans should be established between allied forces operating in adjacent sectors. Such plans should be simple and easily implemented and should include provisions for periodic review and revision to keep step with changes in troop levels and unit deployment.

B. Allied nations have different occupational health and wartime standards and doctrine. US forces should familiarize themselves with the standards of the host nation and that of its allies. If US forces fall under NATO command, NATO STANAGs will provide additional guidance and doctrine. For example, NATO ACE Directive 80-64 provides doctrine guidance for operations near toxic industrial chemicals.

10. Contamination of Supplies. In the presence of a NBC threat, equipment and supplies should be kept in unopened, sealed or covered containers until required for use. The use of chemical agent resistant material will provide good protection against liquid contamination, but even the use of conventional tentage will significantly reduce contamination by a liquid agent for a limited period.

1.9. Protection

1. Protective Masks. Military protective masks may not protect against toxic industrial chemicals. Civilian protective mask used in industrial hygiene and hazardous waste operations may not protect against military NBC agents. It is imperative to ensure that the protective mask being used is appropriate for the situation. USACHPPM and SBCCOM can assist in the selection of the proper masks.

A. Unmasking Procedures without detection equipment. In shady area, have one or two soldiers take a deep breath, hold it, and break their mask seals for 15 seconds with their eyes open. Have them clear and reseal masks. Observe for 10 minutes for symptoms. If no symptoms appear, have the same soldiers break their mask seals, take two or three breaths, clear and reseal masks. Observe for 10 minutes for symptoms. If no symptoms appear, have the same soldiers unmask for 5 minutes and then remask. If no symptoms appear in 10 minutes, it is safe to give the clear signal. Continue to observe the soldiers in case delayed symptoms develop.

B. Unmasking Procedures with M256 or M256A1 Detector Kit. Test with detector kit. If the test is negative, have one or two soldiers move to a shady area if possible and unmask for 5 minutes. Have the soldiers remask. Observe them for 10 minutes for symptoms. If symptoms do not appear, it is safe to give the all clear signal and unmask. The senior leader present may ask higher headquarters for permission. Continue to observe the soldiers in case delayed symptoms develop.

2. MOPP Levels. Soldiers may leave the overgarment jacket open at MOPP1, MOPP2, or MOPP3 allowing greater ventilation. Soldiers may leave the hood open or rolled at MOPP3. At MOPP4, the overgarment jacket must be closed and the hood must be rolled down.
 - A. Estimated length of Chemical Hazard. The estimated time before decreasing MOPP level/unmasking after a confirmed chemical hazard depends greatly on the hazard environment and weather. Chapter 3 from FM 3-7 lists the estimated hazard time for various situations.
 - B. MOPP Gear Exchange. See Chapter 3 from FM 3-7.
3. Collective Protection. To achieve collective protection requires 0.5 inches of water overpressure for softwalled shelters such as tents and 0.2 inches for tight concrete shelters and well-sealed rooms. The requirement for air volume flow (in cubic feet per minute) to achieve such pressures is 0.0367 times the room volume in cubic feet for 0.2 inches and approximately 0.07 times the room volume for 0.5 inches. The M20 blower unit can provide 200 cubic feet per minute of airflow. Use plastic sheets and 100 mph tape to seal all cracks, windows, ducts, false ceilings, electric outlets, etc. to create an airtight environment. (This information was provided by Army document M 27APPE-219, 76-332-219).

Table 1-C: MOPP Levels for Soldiers Not in Collective-Protection

Level	MOPP Gear	
Zero	Overgarment Overboots Mask & Hood Gloves	Carried Carried Carried Carried
1	Overgarment Overboots Mask & Hood Gloves	Worn Carried Carried Carried
2	Overgarment Overboots Mask & Hood Gloves	Worn Worn Carried Carried
3	Overgarment Overboots Mask & Hood Gloves	Worn Worn Worn Carried
4	Overgarment Overboots Mask & Hood Gloves	Worn and Closed Worn Worn and hood rolled down Worn
* During an engagement, the commander may allow personnel protected from liquid agents to operate temporarily without protective gloves. This option could slightly increase the potential for casualties.		

Reference: Table 2-14 from FM 3-7.

Table 1-D: MOPP Levels for Soldiers in Collective-Protection

Level	Ventilate Facepiece	Overpressure
Zero	Assume MOPP zero.	Assume MOPP zero. Overpressure off.
1	Assume MOPP 1.	Assume MOPP zero or MOPP 1. Overpressure on.
2	Assume MOPP2.	Maintain MOPP zero or MOPP1. Overpressure on. Entry exit procedures not required.
3	Assume MOPP3. When mounted, connect ventilated facepiece to mask.	Maintain MOPP zero or MOPP1 unless interior is contaminated. Overpressure on. Exit and entry procedures required if an attack occurs.
4	Assume MOPP3 or MOPP 4. When mounted, connect ventilated facepiece to mask.	Maintain MOPP zero or MOPP1 unless interior is contaminated. Overpressure on. Entry/exit procedures required if an attack occurs.
* During an engagement, the commander may allow personnel protected from liquid agents to operate temporarily without protective gloves. This option could slightly increase the potential for casualties.		

Reference: Table 2-14 from FM 3-7.

1.10. Decontamination

1. See Appendix C of FM 8-10-7 for guidance on patient decontamination. Information about decontamination of specific agents is found in the scientific chapters and in the equipment chapter.
2. General. For chemical weapons, it is imperative that at least limited decontamination is performed as soon as possible. This will diminish the chance of recontamination of the casualty, or contamination of medical personnel and facilities from any agent left on the clothing or equipment. The time it takes for a liquid agent on the skin or clothing to diminish due to evaporations varies for minutes to hours and even days depending on the agent used. Decontamination is a necessity and should be performed as soon as possible. Often careful removal of the clothing and equipment, with spot decontamination of skin areas that may be at risk of recontamination when the clothing is removed, will be just as effective as full decontamination, and can be accomplished more quickly and with fewer personnel. Protecting the wound from any further contamination with protective dressings is desirable. Further management of wounds should follow normal treatment procedures.
3. Personnel. Coordinate with the supported unit to establish and train the decontamination team. While it is the supported unit's responsibility to provide decontamination teams, medical units must be prepared to supervise them. Co-locate the decontamination site near the MTF.
4. Personnel Protection. Personnel performing the decontamination should wear appropriate personnel protective equipment such as protective mask, gloves, and protective overgarments.
5. Monitoring. Some methods of monitoring contamination would be valuable in determining the degree of decontamination required.
6. Disposal. To avoid chemical vapors, clothing and equipment removed from contaminated casualties requires proper disposal. Several methods may be utilized for this purpose, such as

impermeable bags or containers, or bleaching powders. Disposal sites for these items must be marked in accordance with unit policy. See FM 3-7, Appendix C.

7. Patient Decontamination Procedures. These procedures are written for chemical warfare, but are useful for all NBC. Medical personnel performing the decontamination should wear: mask, gloves, and protective overgarments.
 - A. Decontaminate the patient's mask and hood (M291/M258A1 kit or 0.5% chlorine solution). Roll the hood or cut the hood off of the mask after decontaminating the hood.
 - B. Remove gross contamination from the patient's overgarment.
 - C. Remove patient's protective overgarment and personal effects.
 - D. Remove patient's battledress uniform.
 - E. Transfer the patient to a decon litter.
 - F. Remove mask if environment permits. Decontaminate skin (M291/M258A1 kit or 0.5% chlorine solution).
 - G. Transfer the patient across the shuffle pit through the point when the casualty is no longer in MOPP protection AFTER monitoring the patient to ensure that all contamination is removed.

Table 1-E: Equipment Needed to Decontaminate a Company

Three containers (2-gallon capacity). One will hold an immersion heater.	One 50-pound drum of general purpose detergent.
Three containers (3-gallon capacity). Four additional containers required for radiological decon.	1-gallon container of mask sanitizing solution per ten vehicles.
Two M258A1 or M291 decon kits per person.	Four M1 chemical agent monitors (CAMs).
Two boxes of plastic bags.	Four M8A1 automatic chemical agent alarms.
Ten 50-pound drums of STB.	Two immersion heaters with fuel.
Two books of M8 paper per squad.	Two shovels.
One role of M9 paper per squad.	First aid supplies and antidotes.
Four long-handled brushes.	One M256A1 detector kit per squad.
Four large sponges.	One role plastic per company.
Four bundles or rags.	One case paper towels per company.
Four cutting tools (scissors, knives).	Engineer tape.
One filter-air or filter canister per mask.	Protective mask PLL parts.
One hood per mask.	Three AN/PDR77 radiacmeters or AN/VDR
Overdress garments and one set of BDUs per soldier if necessary	
NOTE: If only one radiacmeter is available, use it at Station 5 to monitor personnel. Pile together decontaminated equipment from Station 1 and decontaminated masks from Station 7. After a squad has been monitored through Station 5, an attendant should monitor the equipment pile.	

Reference: Table 3-39 from FM 3-7.

Figure 1-A: Layout for a patient decontamination station

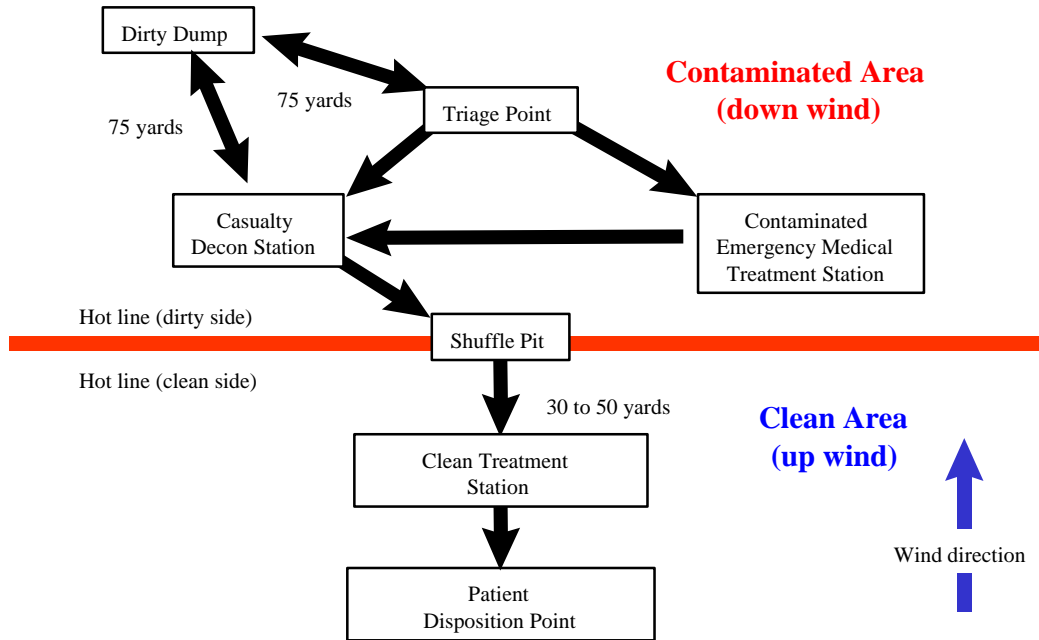

Table 1-F: Personnel Decontamination Lane

Station	Personnel	Equipment
Station 1: Individual Gear Decon	2 attendants 1 monitor (CAM operator)	3 30-gallon canisters, 2 long-handled brushes 2 ponchos or plastic sheets, 1 CAM 8 M8 detector paper, 4 M256A1 kits, 100 trash bags
Station 2: Overboot and Hood Decon	1 attendant	2 cutting tools 60 M258A1 or M295 (or one per person) 2 ponchos or plastic tarps, 100 trash bags
Station 3: Overgarment Removal	1 attendant	10 M258A1/M295, 2 30-gallon containers 100 trash bags
Station 4: Overboot and Glove Removal	1 attendant	2 30-gallon containers, 100 trash bags Engineer tape, Cutting tool
Station 5: Monitor	1 CAM operator 1 aidman or combat lifesaver	1 or more CAM or PDR-77, 5 M8 detector paper 24 M258A1/M295
Station 6: Mask Removal	2 attendants	1M8A1 chemical alarm
Station 7: Mask Decon Point	2 attendants 1 monitor	4 3-gallon containers, 1 or more CAM or PDR- 77, 2 sponges, 1 case paper towels, 1 immersion heater w/container, Mask sanitizing solution
Station 8: Reissue Point	Unit supply NCO Unit NBC NCO	Mask PLL, Overdress garments and BDU's if appropriate

Reference: Table 3-40 from FM 3-7.

1.11. Medical Evacuation and Decision Process

1. A number of ambulances may become contaminated in the course of battle. Optimize the use of resources; use those already contaminated (medical or nonmedical) before employing uncontaminated resources to transport contaminated casualties. Once a vehicle or aircraft has entered a contaminated area, it may be a long time before it can be spared long enough to undergo a complete decontamination. Use ground ambulances instead of air ambulances in contaminated areas; they are more plentiful, are easier to decontaminate, and are easier to replace. However, this does not preclude the use of aircraft.
2. Contaminated casualties. The evacuation of casualties with combined injuries requires careful observation while on route to a surgical unit and autoinjector treatment should be continued if signs of poisoning persist or worsen. Evacuating contaminated patients increases the likelihood that the contamination will spread and it also the patient's exposure to the agent.
3. The relative positions of the contaminated area, forward line of troops, and threat air defense systems will determine where helicopters may be used in the evacuation process. Some helicopters may be restricted to contaminated areas. Ground vehicles should be used to cross the line separating clean and contaminated areas. The routes used by ground vehicles to cross between contaminated and clean areas are considered dirty routes and should not be crossed by clean vehicles. Consider the effects of wind and time upon the contaminants; some agents will remain for extended periods of time.
4. Always keep the rotorwash of the helicopters in mind when evacuating patients, especially in a contaminated environment. A helicopter must not land too close to a decontamination station (especially upwind) because any trace of contaminants in the rotorwash will compromise the decontamination procedure.
5. The policy for medical evacuation out of the theater for casualties from NBC agents should be reviewed. The policy should address both contaminated casualties and those exposed to infectious diseases. Coalition/NATO allies may limit the number of evacuations through their nation to limit any possible spread of infectious diseases. For example, are the standard evacuation channels still open if the NBC agent used is Smallpox? Contagion spread may limit evacuation in quantify areas. Quarantine plans should be adequate to support medical operations.

This page left intentionally blank.

2 NUCLEAR WEAPONS

Table of Contents

2.1.	Casualty Predictions for Nuclear Detonation _____	2-2
2.2.	Medical Planning Specific to Nuclear War _____	2-5
2.3.	Command Radiation Guidance _____	2-9
2.4.	Radiation Exposure States (RES) and Risk Criteria _____	2-11
2.5.	Operations After Nuclear Detonation (Fallout Zone Prediction) _____	2-12
2.6.	Unit Operations in Fallout _____	2-13
2.7.	Nuclear Detonation _____	2-17
2.8.	Radiation from a Detonation _____	2-19
2.9.	Medical Effects from A Nuclear Detonation _____	2-21
2.10.	Psychological Aspects of Nuclear Weapons _____	2-23
2.11.	Radiosensitivity of Various Organs _____	2-23
2.12.	Systemic Effects of Whole-Body Irradiation _____	2-24
2.13.	Management of Radiation Casualties _____	2-26
2.14.	Treatment of Radiation Injuries _____	2-29

List of Tables

Table 2-A:	Radii of Effects in Kilometers versus Weapons Yield _____	2-2
Table 2-B:	Ranges for Probabilities of Injuries from Flying Debris _____	2-3
Table 2-C:	Ranges for Translational Injuries for Different Yield Weapons _____	2-3
Table 2-D:	Probability of Radiation or Thermal Burns _____	2-3
Table 2-E:	Radiation Exposure and Risk Criteria _____	2-11
Table 2-F:	Fallout Zones _____	2-12
Table 2-G:	Shielding Properties of Common Materials _____	2-15
Table 2-H:	The 7:10 Rule for Residual Radiation Decay _____	2-15
Table 2-I:	Radiation Protection Factors of Sand-or-clay-filled Sandbags _____	2-15
Table 2-J:	Radii of Vulnerability for Personnel (distance in meters) _____	2-16
Table 2-K:	Radii of Vulnerability for Equipment (distance in meters) _____	2-16
Table 2-L:	Distribution of Energy from Nuclear Detonation _____	2-17

Table 2-M:	Typical Neutron Dose-to-Total Dose Ratios	2-19
Table 2-N:	Relative Radiosensitivity of Various Organs	2-23
Table 2-O:	Preliminary Triage of Casualties with Possible Radiation Injuries	2-28
Table 2-P:	Radiation Doses and Combined Injuries	2-28
Table 2-Q:	Medical Response to Nuclear Radiation	2-30, 31
Table 2-R:	Medical Aspects of Radiation Injury in Nuclear War	2-32, 33
Table 2-S:	Disposition of Radiation Injury in Nuclear War	2-34, 35

List of Figures

Figure 2-A:	Nuclear Risk Assessment	2-4
Figure 2-B:	Expected Response to Radiation for Physically Demanding Tasks	2-10
Figure 2-C:	Expected Response to Radiation for Physically Undemanding Tasks	2-10
Figure 2-D:	Yield Estimates (KTs) for Illumination Times (seconds)	2-18
Figure 2-E:	Flashblindness and Retinal Burn Safe Separation	2-22
Figure 2-F:	Clinical Effects of Whole Body Irradiation in Humans	2-36
Figure 2-G:	Dose versus LD for Whole Body Irradiation	2-36

2.1. Casualty Predictions for Nuclear Detonation

Table 2-A: Radii of Effects in Kilometers versus Weapons Yield

Effect	1 KT	20 KT	100 KT	1 MT	10 MT
Nuclear Radiation (1,000 cGy)	0.71	1.3	1.6	2.3	3.7
Blast (50% incidence of translation with subsequent impact with a non-yielding surface)	0.28	1.0	1.4	3.8	11.7
Thermal (50% incidence of 2nd-degree burns to bare skin, 10 km visibility)	0.77	1.8	3.2	4.8	14.5

Reference: Table 2-1 from FM 8-10-7.

Table 2-B: Ranges for Probabilities of Injuries from Flying Debris

YIELD (KT)	Range for given probability of serious injury in km		
	1% Probability of serious injury	50% Probability of serious injury	99% Probability of serious injury
1	0.28	0.22	0.17
10	0.73	0.57	0.44
20	0.98	0.76	0.58
50	1.4	1.1	0.84
100	1.9	1.5	1.1
200	2.5	1.9	1.5
500	3.6	2.7	2.1
1000	4.8	3.6	2.7

Reference: Table 2-3 from FM 8-10-7.

Table 2-C: Ranges for Translational Injuries for Different Yield Weapons

YIELD (KT)	Range in km for given probability of Blunt injuries & fractures			Range in km for given probability of fatal injuries	
	>1%	50%	99%	>1%	50%
1	0.38	0.27	0.19	0.27	0.19
10	1.0	0.75	0.53	0.75	0.53
20	1.3	0.99	0.71	0.99	0.71
50	1.9	1.4	1.0	1.4	1.0
100	2.5	1.9	1.4	1.9	1.4
200	3.2	2.5	1.9	2.5	1.9
500	4.6	3.6	2.7	3.6	2.7
1000	5.9	4.8	3.6	4.8	3.6

Data account for ground friction and consider only prone personnel.

Reference: Tables 4-IV and 4-V from FM 8-9 (Part I).

Table 2-D: Probability of Radiation or Thermal Burns

YIELD OF WEAPON	1 KT	10 KT	100 KT	1 MT	10 MT
Range (km) for production of second-degree burns on exposed skin	0.78	2.1	4.8	9.1	14.5
Duration of thermal pulse in seconds	0.12	0.32	0.9	2.4	6.4

Reference: Table 4-VI from FM 8-9 (Part I) and Table 2-7 from FM 8-10-7.

Figure 2-A: Nuclear Risk Assessment

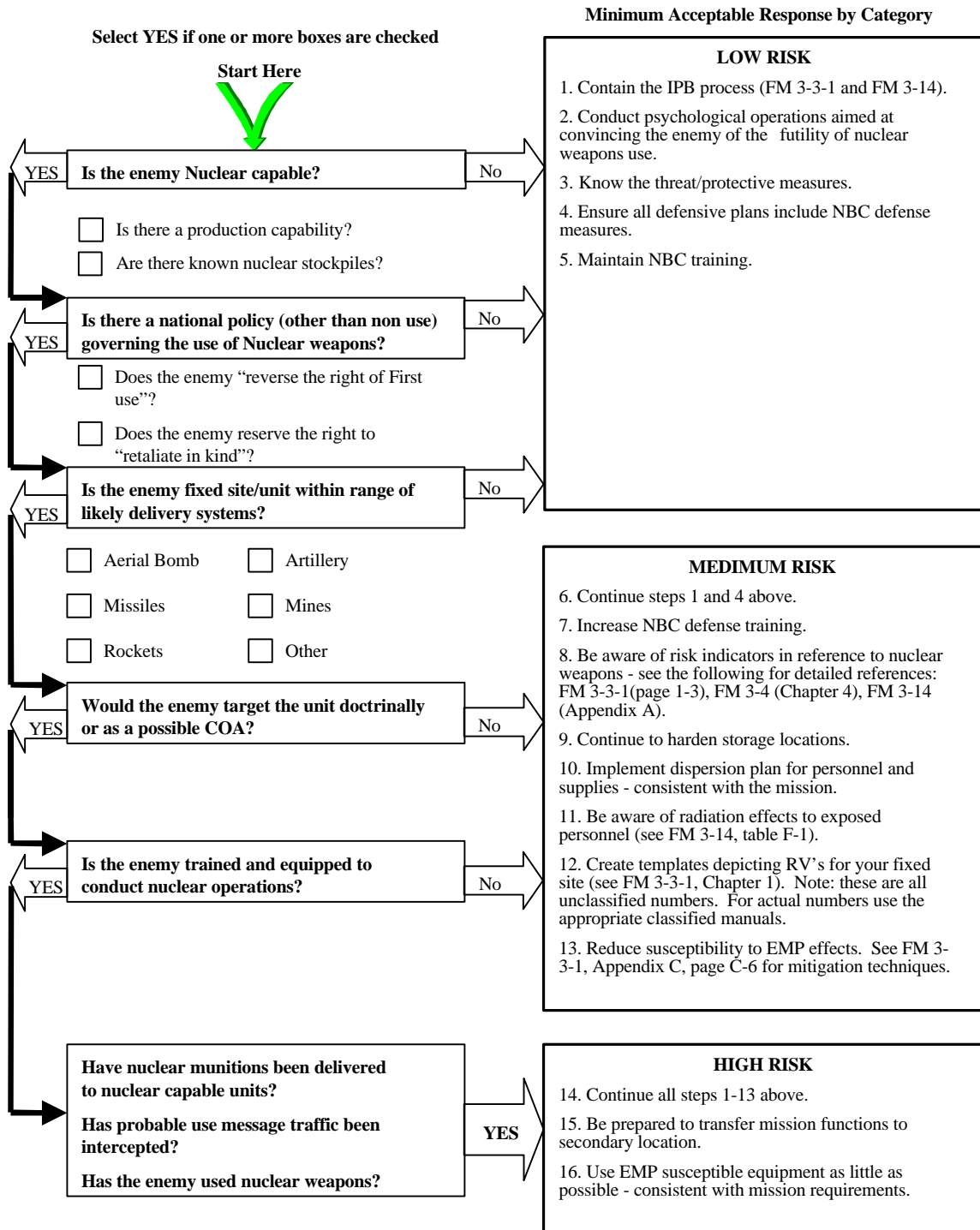

Reference: Figure I-5 of Joint Pub 3-11 (Draft).

2.2. Medical Planning Specific to Nuclear War

1. Reference: FM 8-9 (Part I).

2. Introduction.

A. The problems facing medical planners and commanders in preparing for operations on a nuclear battlefield can be divided into two distinct categories. The first category, staff-level planning and operational activities, includes those actions that must be accomplished prior to the initiation of a nuclear war to minimize the prompt effects of enemy nuclear attacks. The second category, unit planning and operational activities, includes those actions which must be accomplished at the unit level to minimize the immediate and delayed effects of enemy nuclear attacks in order to ensure continued effective medical operations in a nuclear environment. This chapter will address itself to some of the problems unique to these categories.

B. Medical commanders may expect at least 10-20 percent casualties (including fatalities) within a division-size force that has experienced a retaliatory nuclear strike. This prediction only considers injury caused from the radiation, but not from secondary injuries such as displacement, falls, fire, spills, flying fragments, rolled vehicles, etc as many of the injured will be suffering combined injuries.

C. Research with animal models has led to the conclusion that the prognosis of patients suffering combined injuries will be worse than the prognosis of patients suffering the same magnitude radiation exposure. In fact, the LD50/60 may be reduced from 450 centigray (cGy) (free in air) to as low as 300 cGy (free in air). The inference from this information is that military personnel who receive subcasualty-producing exposures of nuclear weapons effects might now require medical attention because they have received combined injuries.

D. The electromagnetic pulse (EMP) produced by nuclear explosions will greatly impact medical operations by interfering with electronic equipment. Medical equipment is generally commercial "off the shelf" technology that cannot tolerate EMP. If warned of a nuclear detonation, one can prevent damage from EMP by turning off the equipment and, in some cases, burying the equipment in the ground.

E. Planning for nuclear battlefields should be done within the context of biological and chemical warfare as it is perceived that an enemy may employ any variety of their weaponry at any given time.

3. Staff-level Medical Planning and Operational Activities

A. General. Nuclear weapons can generate more casualties than medical resources can normally handle. Practical, problem-related preparation, training, and procedures must be in place to minimize the medical shortfall.

B. Organization of the Medical Support System.

(1) Medical planners of each country will determine the type of organizational structure that best meets their country's individual and specific needs. Regardless of the type of

organizational structure that is finally evolved, it will serve the functions for which it was designed and be responsive to the requirements of the armed forces it will support.

(2) Nuclear weapons can rapidly destroy unwarned and unprepared battalion sized units. Medical units are often co-located with other combat service support units. This proximity may cause medical personnel to be in the nuclear target area. Decentralization, cross-training, moving often, adding redundant capabilities, and conducting split-based operations are all mechanisms. A balance must be made between:

- (a) Convenience and immediacy of service to supported units prior to the war; and
- (b) The survival of medical assets so that care can be provided once war has begun.

4. **Coordination with Other Allies.** In Combined Operations, medial support is traditionally a national responsibility. (This is the existing NATO agreement). However, this policy is not likely to be optimal in an environment where nuclear weapons are employed. Mutual support plans would greatly increase the ability to respond with sufficient medical capability. Standardization of procedures and equipment (to the degree possible), familiarity with each other's capabilities, conducting mass casualty exercises and providing liaisons will greatly facilitate emergency operations.
5. **Casualty and Damage Assessment.**
 - A. The staff of combat units generally has an efficient system of casualty and damage assessment. After a nuclear detonation, the S2/S3 or the NBC cell will probably issue casualty and damage predictions.
 - B. An accurate prediction of the number of casualties resulting from a nuclear strike is necessary for adequate medical support and should be made available to medical staff officers. Basic casualty estimations should be broken down into types of casualties so that total bed requirements can be more accurately predicted, particularly in view of the prolonged hospitalization associated with the treatment of patients with burns and combined injuries. One enemy nuclear strike on a given area can produce casualties far in excess of the treatment capability of local medical resources. The effectiveness and adequacy of the rescue, evacuation, and treatment effort during the first 24 hours after such an attack are critical. Area commanders must be informed rapidly of the magnitude of the damage and the estimated medical load in order to provide rescue and treatment resources in sufficient quantities or request the proper assistance from higher headquarters, adjacent units, or allied units. NATO AMedP-8 (Draft) provides information on the casualty rates from a nuclear detonation.
 - C. Various systems of casualty and damage assessment have been developed. Such systems are rather involved and depend on many variables such as method and time of delivery, type of burst, size of weapon, weather and climatic conditions, wind direction and speed, fallout dose rate, etc. The gathering and compilation of such data are time consuming and may not be accomplished until many hours after the disaster. The US Army Office of the Surgeon General is developing a system of casualty estimation that will provide rapid and reasonably accurate estimates of the number and types of casualties produced by a given enemy nuclear attack.
 - D. Areas of radiation contamination cannot be determined by aerial reconnaissance. Significant prompt radiation occurs only within the area of severe blast damage for ground bursts. Radiation from large enhanced weapons exploded above the surface (airburst) would cause radiation injuries

beyond the blast-damaged area. Fallout and residual radiation is a hazard for survivors, rescuers, and medical personnel. Individual and unit dosimetry will be critical in assessing radiation exposure and survivability potential.

6. Logistical Support System.

A. The success of medical support effort depends to a great degree on the adequacy of prewar logistical planning and preparation. Logistical plans should provide not only for medical supplies and equipment but also general supplies, food, clothing, water purification apparatus, radiation detection and measurement instruments, communications equipment, and modes of transportation.

B. The location of medical resources is extremely crucial. Resources must be close to the area of probable greatest need without being concentrated in areas likely to become targets for enemy attack. This means that medical planners must compromise between dispersal and the capability of the logistical system to move supplies and patients. Medical planners should take advantage of the various stages of military preparedness, which may precede the actual outbreak of hostilities, to implement dispersal and augmentation plans that have been developed. Extensive pre-positioning during peacetime is not practical because of the problems associated with long-term maintenance of medical equipment and medications in storage.

C. Conservation of limited supplies requires efficient stock control procedures. Modern automatic data processing systems can achieve the necessary degree of control when properly used. However, when automatic data processing equipment is employed, consideration must be given to the establishment of protected sites, alternate facilities, and hardening to reduce vulnerability. Only a limited number of computer facilities will be available, and their protection is essential. Their practicability in theaters of operation has not been demonstrated.

D. The supply system must also be prepared to provide for increased demands for certain types of medical and general supplies and equipment, e.g., whole blood, blood expanders, burn kits, dressings, individual protective clothing, decontamination equipment, radiac instruments, etc. Careful thought must be given to short- and long-range supply, equipment, and maintenance requirements.

7. Personnel and Medical Unit Requirements. It is highly probable that entire medical units including large hospitals will be lost or will become incapable of functioning because of large-scale losses in personnel and equipment. Hospitals should be dispersed away from potential nuclear target areas to improve the probability of these facilities surviving nuclear weapons attacks. This mitigation technique, however, cannot be relied upon to prevent significant loss of medical treatment capability. Consequently, planning for whole unit replacement must be considered. These units would come from existing military hospitals or from reserve civilian units, depending upon relative availability and the mobilization plans of the individual country.

8. Medical Unit Planning and Operational Activities

A. General. Like the medical support system as a whole, the planning and operations of a field medical unit are keyed to the nature and functions of the forces the unit supports. While the problems to be confronted by medical units on the nuclear battlefield will be similar in some respects to those associated with conventional warfare, there are some dramatic differences. These include the vastly increased numbers of casualties to be handled, the need to operate in

fallout, and the requirements to treat and decontaminate contaminated patients. These and other problems related to unit planning and operations are described in this section.

B. Unit Mobility.

(1) With the changes in transportation capabilities and associated concepts of operations, the mobility of modern military forces has a tremendous impact on how a medical unit must function. It is essential that the medical facilities that are operating in close support of highly mobile forces be as mobile as those forces. This imposes severe restrictions on how long they can retain patients in one location. An efficient and flexible plan of evacuation is absolutely essential in order for forward medical facilities to retain mobility.

(2) The classical concept of military medical care has been that a chain of surface or ground evacuation is available. Using helicopter evacuation, immediate casualty collection points may be bypassed so that wounded personnel can be taken directly to well-equipped hospital facilities located relatively far to the rear reducing the need for an extensive ground evacuation system. However, reorganization of the medical evacuation system in which the intermediate elements are deleted, based primarily upon the proposed use of helicopter evacuation, may not be possible or desirable. Helicopter evacuation may become severely limited if nuclear weapons are used extensively, and the success of helicopter evacuation is certainly affected by weather conditions and enemy air capabilities. Therefore, a ground based evacuation system must be planned for since it could easily become the primary means of evacuation.

C. Rescue and Damage Control.

(1) Dispersal, communication discipline, rapid movement, and other techniques units use to reduce the probability of being targeted by nuclear weapons also make it more difficult for medical units to plan for, and respond to, nuclear attack. Communication systems will also likely be degraded in this environment. Medical planners must overcome these difficulties by focusing on communication, coordination, and preparatory planning. Specifically, a close liaison must be established with the G3, G4, Chemical Officer, G6, and unit Surgeons. Information of interest will include unit size, unit location and dispersal; unit defensive postures, local medial support plans; local emergency plan, and the local nuclear weapon response plan. The medical planner's goal is a comprehensive mutually supportive medical nuclear response plan. This plan must include an overarching plan with local annexes.

(2) Rescue operations, damage control, and medical operations are complementary and should be closely coordinated. However, it should be borne in mind that even with outside medical augmentation, the medical load will be overwhelming and every effort should be made to conserve these resources so as to provide medical care for the maximum number of injured personnel. Therefore, medical unit personnel should not be taken from primary patient care duties and used to perform rescue and damage control operations. Rescue and damage control personnel should be designated, trained, and equipped to render basic lifesaving first aid.

(3) Rescue efforts may have to be conducted in the presence of fallout contamination or with the possibility of fallout arriving at a later time. Radiation monitors should be available to evaluate the radiation dose rates and verify stay times. Experts are needed to review the data and provide specific recommendations to the commander as to the hazards present to include the development of safety stay times in contaminated areas. Medical radiation experts are

normally assigned to Medical Groups and to Medical Battalions. Where there is radiological contamination, radiation dose rates may be so high that rescue operations become very hazardous, and must be conducted with caution by members of organized rescue squads specially trained and equipped to assess radiological hazards. Close coordination should be established between medical elements and rescue, evacuation, and damage control elements to facilitate establishing consolidated staging, treatment and evacuation sites in areas of relative safety from residual radiation, secondary explosions, fires, etc.

9. Handling Large Numbers of Casualties.

A. Triage of patients with possible radiation injuries is covered later in this Chapter.

B. It may become necessary for all hospitals to be able to establish and operate a continuous minimal treatment facility as part of the regular operational plan. This minimal treatment facility would be used to house those patients who cannot return to duty and who do not require or warrant hospitalization in the regular or intensive treatment part of the hospital. This is necessary since, whether patients in an evacuation chain are hospitalized or not, they must be held somewhere and accounted for. They must be housed, fed, and given at least minimal care, and they must be near definitive medical care so that they can receive additional medical treatment in an efficient manner when time and resources permit. In such a minimal treatment facility, the emphasis would be on self-care since the staffing would have to be minimal.

C. The use of nuclear weapons may require evacuation of a large number of casualties from theater.

2.3. Command Radiation Guidance

1. References: FM 8-9 (Part I) and NATO STANAG 2083.
2. Line commanders at all levels will require advice from medical advisors concerning the effects of accumulated doses of radiation on the health of their personnel and the hazards of potential exposures when operations must be conducted in areas contaminated with fallout. This advice must be practical and based upon an understanding of the requirements of the mission as well as knowledge of the diversity of human response to radiation. The effects of radiation must not be either minimized or exaggerated, and their proper place relative to the other hazards of combat must be understood.
3. STANAG 2083 has been established, incorporating the most recent guidance on the operational effects of radiation exposures.
4. If exposures can be maintained below 125 cGy, the overall effectiveness of combat units will not be significantly degraded. However, if the exposures become relatively large (as may occur when an aggressor uses nuclear weapons), then tactical commanders must be advised of their forces' capability to continue the fight. Figures 2-B and 2-C provide an estimate of the combat effectiveness of combat units as functions of acute dose and time postexposure. These figures have been developed from subhuman primate studies at the Armed Forces Radiobiology Research Institute (AFRRI) (for times less than 60 minutes, postexposure) and from an assessment of how radiation sickness signs and symptoms will affect the performance of combat tasks (for times greater than 60 minutes, postexposure). The prediction associated with those identified as being "combat effective" is that they will be suffering radiation sickness signs and symptoms of such a

nature that they will be able to maintain their performance of at least 75 percent of their preexposure performance level. Those predicted as being "performance degraded" could be operating at a performance level between 25 and 75 percent of their preexposure performance. Those predicted as being "combat ineffective" should be considered as being capable of performing their tasks at 25 percent (at best) of their preexposure performance level. Of course, these predictions are based on combatants suffering only one stressor, that being ionizing radiation exposures. The prediction of performance capacity of those having received ionizing radiation exposures will now have to be considered together with how other stressors (conventional injury, endemic disease, continuous duty (sleeplessness), time in combat, fatigue, etc.) might affect the total performance capability of the force. Also, other refinements to the method should be considered; by example, the description of all tasks, as being either physically demanding or physically non-demanding may be too simplistic. For instance, tasks that require great, continuous concentration (e.g., monitoring of radar screens) may not fit well into these gross categories.

Figure 2-B: Expected Response to Radiation for Physically Demanding Tasks

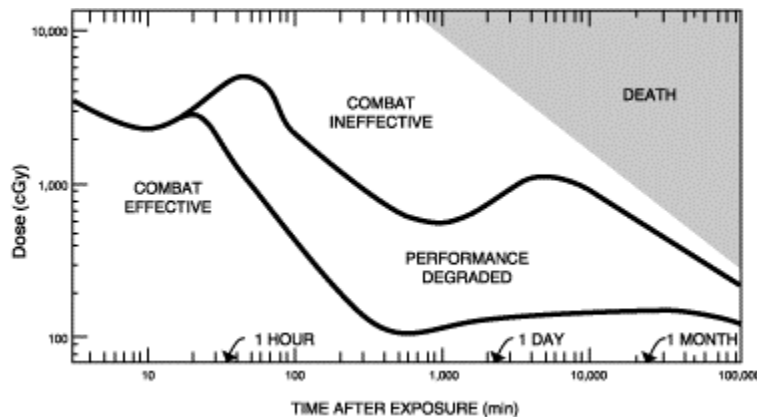

Reference: Figure 7-I from FM 8-9 (Part I).

Figure 2-C: Expected Response to Radiation for Physically Undemanding Tasks

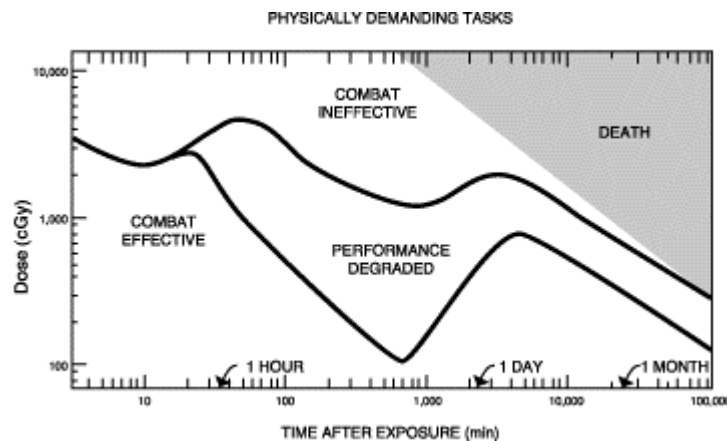

Reference: Figure 7-II from FM 8-9 (Part I).

2.4. Radiation Exposure States (RES) and Risk Criteria

1. References: FM 3-3-1, Joint Pub 3-12.2, FM 3-7, FM 8-9 (Part I), and NATO STANAG 2083 (most recent guidance on the operational effects of radiation exposures). See Appendix A of FM 3-3-1 for a complete description of the Operational Exposure Guidance (OEG),
2. RES Categories.
 - A. The radiation exposure states have been changed to reflect new performance degradation modeling. The new states will appear in Joint Pub 3-12.2 and become doctrine.

Table 2-E: Radiation Exposure and Risk Criteria

Radiation Exposure State (RES)	Total Past Cumulative Dose (cGy)	Exposure Criteria for a Single Operation Which Will Not Result in Exceeding the Dose Criteria for the Stated Degree of Risk STATE (See notes 4 & 5) (cGy)
RES-0 Units	No exposure	Negligible Risk < 75 Moderate Risk < 100 Emergency < 125
RES-1 Units	Greater than 0, Less than or equal to 75	Negligible Risk < 35 Moderate Risk < 60 Emergency < 85
RES-2 Units	Greater than 75, Less than or equal to 125	Any further exposure is considered to exceed a negligible or moderate risk
RES-3 Units	Greater than 125	Any further exposure will exceed the emergency risk

Reference: Joint Pub 3-12.2 (Draft).

3. Risk Criteria. Degrees of risk are defined in percentages of either casualties or performance degradation. From a military radiation standpoint, vomiting is the medical effect defining performance degradation. A casualty is defined as an individual whose performance effectiveness has dropped by 25% from normal. Vomiting and diarrhea are commonly called nuisance effects (See Joint Pub 3-12.2 for a complete discussion). Nuisance effects can range from vomiting, skin burns, and ear drum rupture to nausea. These symptoms, at low radiation levels, may take hours to develop. Individuals thus exposed should be able to function in the important hours after a nuclear attack and after the first set of symptoms abate.
 - A. Negligible Risk. Negligible risk is the lowest risk category. This dose will not cause any casualties. Troops receiving a negligible risk dose will experience no more than 2.5 percent nuisance effects. Negligible risk is acceptable when the mission requires units to operate in a contaminated area and should not be exceeded unless a significant advantage will be gained.
 - B. Moderate Risk. Moderate risk is the second risk category. This dose generally will not cause casualties. Troops receiving a moderate risk dose will experience no more than 5 percent incidence of nuisance effects. Moderate risk is usually acceptable in close support operations. Moderate risk must not be exceeded if troops are expected to operate at full efficiency. These personnel will be at a much greater risk if they receive any additional traumatic injuries.

C. Emergency Risk. In this category, not more than 5 percent casualties are expected. Nuisance effects may exceed the 5 percent level. The emergency risk dose is only acceptable in rare situations, termed disaster situations. Only the commander can decide when the risk of the disaster situation outweighs the radiation emergency risk.

4. Reclassification of RES. The commander, on the advice of the unit surgeon, can reduce the RES category of his unit. Possible repair of radiation damage is 50% after 30 days, 90% after 90 days, and 10% of damage never repaired.

2.5. Operations After Nuclear Detonation (Fallout Zone Prediction)

1. References: FM 3-3-1 and FM 3-7.
2. Actions After an Attack
 - A. Cover mouth with handkerchief.
 - B. Organize survivors and assist casualties
 - C. Send NBC 1 report.
 - D. Secure and organize equipment.
 - E. Begin continuous monitoring.
 - F. Conduct damage assessment and restoration of combat power.
 - G. Improve protection against possible fallout.
3. Simplified Fallout Prediction (M5A2)
 - A. Information required: NBC 2 nuclear report and effective downwind message.
 - B. Record date-time of burst, grid zone, and wind direction on M5A2.
 - C. Determine Zone I from the monogram printed on the M5A2, draw arc on M5A2, and label.
 - D. Zone II = 2 x Zone I; draw an arc, and label.
 - E. Draw tangents from cloud radius to end of Zone I.
 - F. Darken the perimeter.
 - G. Draw time-of-arrival arcs and label.
 - H. Orient azimuth on predictor with grid north.

Table 2-F: Fallout Zones

Zone	Dose to Exposed, unprotected personnel from fallout
Zone 1 (immediate operational concern)	More than 150 cGy within 4 hours.
Zone 2 (secondary hazard)	Less than 150 cGy within 4 hours. More than 50 cGy within 24 hours.
Outside the predicted area	No more than 50 cGy in 24 hours.

Reference: Figure 4.6 of FM 3-3-1.

4. Radiological Monitoring.
 - A. Periodic monitoring (readings at least once every hour) is done when—
 - (1) Intelligence indicates a threat of nuclear war.
 - (2) Nuclear war has been initiated or NBC threat status (nuclear) is Serial 3.
 - (3) Continuous monitoring falls below 1 centigray per hour (cGy/hour).
 - B. Continuous monitoring is done when—
 - (1) A nuclear detonation is seen, heard, or reported.
 - (2) Periodic monitoring records 1 cGy/hour or higher.
 - (3) Ordered by the unit commander.
 - (4) A warning of expected contamination (NBC 3) is received.

2.6. Unit Operations in Fallout

1. References: FM 8-9 (Part I) and FM 3-7.
2. Whenever large areas are contaminated by fallout, operations of all units, including medical, will be hampered to varying degrees, depending upon the level of contamination. When a serious radiation hazard exists, medical unit commanders will be faced with the question of whether to continue operation and accept hazardous exposures to their personnel or to take shelter, an action which may seriously reduce their unit's ability to care for patients. In order to make the correct decision, they will require adequate information, and this, in turn, necessitates them having the following capabilities:
 - A. An effective radiation monitoring capability to correctly measure the radiation hazard.
 - B. The ability to make rapid estimates of the future dose and dose rates expected.
 - C. Satisfactory communication with other units and higher headquarters to report the fallout situation and to receive fallout warnings, information, guidance, and orders.
3. Data required to permit proper situation analysis and decision making include:
 - A. Whether the unit is or will be in a fallout area.
 - B. Expected time of arrival of fallout, or if the fallout has arrived, how long before it will essentially all be on the ground and radiation dose rates begin to decline.
 - C. The maximum radiation dose rates expected.
 - D. The adequacy of existing or immediately available facilities as fallout shelters.
 - E. Evaluation of these data together with the operational situation permits proper command decisions to be made relative to moving the unit, diverting patients to other medical treatment units, moving into fallout shelters, or remaining in place and continuing normal operations.
 - F. **Refer to the chapter on Radiological Hazard for details on Radiological Surveys.**
4. Performance of Mission in a Radiological Contaminated Environment.
 - A. Medical units required to remain in areas of high dose rates can survive and continue their patient care activities if adequate shelter is available to shield against radiation. Many materials

available on the battlefield afford substantial shielding (Table 2-G). Use of some of these materials, such as concrete, requires significant engineering support and prior construction. Earth, however, affords excellent protection and can be employed with minimum engineering effort.

B. In some cases, it is unnecessary to do any construction since there may be structures and terrain features already available that will afford excellent protection from radioactive fallout. Tunnels, caves, culverts, overpasses, ditches, ravines, and heavily constructed buildings are examples. In the case of existing buildings, below ground basements give the best protection. With minimum effort, windows and overhead floor can be sandbagged or covered with dirt to provide additional protection.

C. It should be a matter of policy for mobile medical units to locate in or near existing shelter whenever possible. When either fixed facilities or mobile units are unable to locate near existing shelter, adequate shelter must be constructed. Elaborate shelters are not required since normally they need to be occupied continuously only during the period of high radiation dose rates.

D. It will be very difficult to predict accurately the rate of fallout decay. Therefore, decisions relative to operations in fallout areas should be based on actual survey data. However, it will not be possible or desirable to expose personnel to do area monitoring when dose rates are very high. Therefore, a reliable method of estimating fallout decay is required. Assuming a single nuclear detonation, Table 2-H demonstrates a simple and reasonably accurate method of estimating residual radiation decay. It must be noted that these calculations are most accurate only after all fallout is on the ground and the dose rate is beginning to decrease.

5. Field Expedient Fallout Shelters.

A. There are a number of field expedient fallout shelters. The more common ones are briefly described and discussed below.

(1) The Dozer Trench. Here a trench of about 2.7 meters wide and 1.2 meters deep is dug with the aid of a dozer. It is estimated that one dozer with its operator could cut six 30 meter trenches in about 5 hours. About 0.6 m of trench would be required for each person to be sheltered; thus, in 5 hours, shelters could be constructed for approximately 300 patients and personnel. Protection and comfort can be improved from unit resources as time passes by digging the trench deeper, undercutting the walls and erecting tents over some portions of the trench. Such trenches should provide adequate fallout shelter for most fallout situations.

(2) Dug-In Tents of a Mobile Hospital. The tents of a mobile hospital could be dug in to a depth of approximately 1.2 meters and would provide more comfort than the dozer trench described in the above paragraph. Such dug-in tents, however, have two principal drawbacks. First, they offer far less radiation protection than dozer trenches and second, they require considerably more in the way of engineering efforts.

(3) Vehicle-Earth Shelter. A very effective shelter can be constructed for mobile medical units with organic transportation by combining the use of unit vehicles and dirt. For example, two large tents can be joined end-to-end and a shallow trench dug around them for the vehicles. The dirt is piled carefully on the outside of the trench. An additional 15-cm trench is dug for the outer wheels of the vehicles. This combination of dirt and vehicles can give as much as 80% protection if fallout contamination is collected and removed from inside the

rectangle thus created. Tent liners and ponchos can be used for this purpose. This expedient method of erecting shelter requires about 2 hours to build and can be occupied or evacuated in a matter of minutes. As with other expedient shelter, it could be constructed at the time the unit occupies the position.

B. Regardless of the type of shelter employed, an effective system must be developed to accomplish certain actions required for the efficient operation of the shelter. In the case of medical units involved in the active care of patients, it is probably advisable to separate the shelter management functions from those of patient care. Those individuals assigned the responsibility of shelter management must provide for such essential functions as radiological monitoring, safe food and water, monitoring water storage facilities to prevent leakage and contamination, arranging for sleeping facilities, controlling fire hazards, enforcing health and sanitation rules, and providing for waste disposal. Shelter management plans must be developed prior to occupying shelters and must be familiar to all assigned personnel.

C. See Chapter 4 from FM 3-7 for tables of transmission factors for tanks, vehicles, etc.

Table 2-G: Shielding Properties of Common Materials

Material	Half-value layer thickness*
Steel	2 cm
Concrete	6 cm
Earth	8 cm
Water	12 cm
Wood	22 cm
*Thickness required to reduce the incident dose or dose rate	

Reference: Table 7-II from FM 8-9 (Part I).

Table 2-H: The 7:10 Rule for Residual Radiation Decay

t – Time after detonation (hr)	Dose rate at time t divided by the dose rate at 1 hour
1	-
7	0.1
49	0.01
343	0.001
*Assuming a single nuclear detonation	

Reference: Table 7-III from FM 8-9 (Part I).

Table 2-I: Radiation Protection Factors of Sand-or-clay-filled Sandbags

Soldier in:	Radiation Protection Factor
Open	None
Open foxhole, 4 feet deep	8
Same with 1 layer (4 inches)	16
Same with 2 layers (8 inches)	32
Same with 3 layers (12 inches)	64

Reference: Table 4-2 from FM 3-7.

Table 2-J: Radii of Vulnerability for Personnel (distance in meters)

Yield (KT)	Lethal Range for Personnel				
	Open	Open Foxholes	APC	Tanks	Earth Shelter
0.1	700	600	600	500	300
0.5	900	800	800	700	450
1	1,200	900	900	800	500
3	2,000	1,100	1,200	1,000	700
6	2,500	1,200	1,250	1,100	800
10	3,200	1,300	1,300	1,250	900
20	4,000	1,500	1,450	1,400	1,000
30	5,000	1,600	1,500	1,500	1,100
50	6,000	1,800	1,700	1,700	1,300
100	8,000	1,900	1,800	1,800	1,400
200	12,000	2,000	1,900	1,900	1,500
300	14,000	2,100	1,950	1,950	1,600

NOTES:

1. Radii listed are distances at which a 5 percent incidence of effect occurs.
2. The height of burst is $60 * W^{1/3}$ meters, where W = yield in kilotons.
3. To obtain a radius of vulnerability, enter the Yield Column of the nearest yield. If exactly halfway between yields, enter with larger yield. Data listed in table above is for training use only. Use the data in FM 1.1-31-2 (S) whenever possible.

Reference. Table 4-11 from FM 3-7.

Table 2-K: Radii of Vulnerability for Equipment (distance in meters)

Yield (KT)	Moderate Damage				Severe Damage		
	Wheeled vehicles		Tanks	Towed	Supply	Randomly Parked Helicopters	
	Exposed	Shielded		Arty	Depot	Cargo & Transport	Light Observation
0.1	200	150	100	100	100	400	500
1	400	350	300	250	250	700	1,100
3	600	500	500	400	450	1,000	1,600
6	700	600	600	500	500	1,200	1,900
10	800	700	700	600	600	1,500	2,500
20	1,000	900	900	800	800	1,900	3,400
30	1,200	1,100	1,000	900	950	2,200	3,700
50	1,700	1,500	1,200	1,200	1,400	2,700	4,500
100	2,200	1,900	1,300	1,300	1,700	3,200	5,700
200	2,600	2,000	1,500	1,500	1,900	3,700	6,200
300	3,000	2,100	1,600	1,600	2,000	3,800	7,100

NOTES: Same notes as previous table.

Reference. Table 4-11 from FM 3-7.

2.7. Nuclear Detonation

1. References: FM 3-3-1 (detailed explanation of burst determination and avoidance of high level nuclear hazards), FM 8-9 (Part I), and FM 8-10-7 (Chapter 2).
2. General. The principal physical effects of nuclear weapons are blast, thermal radiation (heat), and nuclear radiation. These effects are dependent upon the yield (or size) of the weapon expressed in kilotons (KT), physical design of the weapon (such as conventional and enhanced), and upon the method of employment.

Table 2-L: Distribution of Energy from Nuclear Detonation

Percent of Energy	Physical Appearance
50	Blast
35	Thermal radiation
4	Initial ionizing radiation (neutrons and gamma rays emitted within the first minute)
10	Residual nuclear radiation (fallout)
1	Electromagnetic pulse (EMP)

NOTE: For a low altitude detonation of a moderate-sized (3 to 10 KT) weapon

Reference: Figure 2-1 from FM 8-10-7.

3. Types of Bursts. The altitude at which the weapon is detonated will largely determine the relative effects of blast, heat, and nuclear radiation. Nuclear explosions are generally classified as airbursts, surface bursts, subsurface bursts, or high altitude bursts.
 - A. Airbursts. An airburst is an explosion in which a weapon is detonated in air at an altitude below 30 km but at sufficient height that the fireball does not contact the surface of the earth. An air burst may cause considerable damage and injury. Burns to exposed skin may be produced over many square kilometers and eye injuries over a still larger area. Initial radiation will be a significant hazard with smaller weapons, but the fallout hazard can be ignored. The fission products are generally dispersed over a large area of the globe unless there is local rainfall resulting in localized fallout. In the vicinity of ground zero, there may be a small area of neutron-induced activity that could be hazardous to troops required to pass through the area. Tactically, airbursts are the most likely to be used against ground forces.
 - B. Surface Burst. A surface burst weapon is detonated on or slightly above the surface of the earth so that the fireball actually touches the land or water surface. The area affected by blast, thermal radiation, and initial nuclear radiation will be less extensive than for an air burst of similar yield, except in the region of ground zero where destruction is concentrated. In contrast with airbursts, local fallout can be a hazard over a much larger downwind area than that which is affected by blast and thermal radiation.
 - C. Subsurface Burst. A subsurface burst weapon is detonated beneath the surface of land or water. Cratering will generally result from an underground burst, just as for a surface burst. If the burst does not penetrate the surface, the only other hazard will be from ground or water shock. If the burst is shallow enough to penetrate the surface, blast, thermal, and initial nuclear radiation effects will be present, but will be less than for a surface burst of comparable yield. Local fallout will be very heavy if penetration occurs.

D. High Altitude Burst. A high altitude burst weapon is exploded at such an altitude (above 30 km) that initial soft x-rays generated by the detonation dissipate energy as heat in a much larger volume of air molecules. There the fireball is much larger and expands much more rapidly. Significant ionization of the upper atmosphere can occur causing severe disruption in communications. They also lead to generation of an intense electromagnetic pulse (EMP) that can significantly degrade performance of electronic equipment or even destroy them. There are no known biological effects of EMP; however, indirect effects may result from failure of critical medical equipment.

E. Enhanced Radiation (ER) Weapons. An enhanced radiation weapon has an output in which neutrons and x-rays are made to constitute a substantial portion of the total energy released. An ER weapon's total energy would be partitioned as follows: 30% as blast; 20% as thermal; 45% as initial radiation; and 5% as residual radiation. A 3-kiloton ER weapon will produce the nuclear radiation of a 10-kiloton fission weapon and the blast and thermal radiation of a 1-kiloton fission device.

4. Calculation of Burst.

A. The report of a nuclear burst will most often come from the tactical side of the house. The AMEDD Officers will most likely supervise the NBC reporting of the burst for effected medical units and also analyze the NBC reports in order to prepare for casualties. FM 3-3-1 details the determination of the burst.

B. FM 3-3-1 details the steps needed to determine the yield from cloud parameters. The M4A1 nuclear yield calculator is designed to provide rapid yield estimation based on any parameter except cloud-top or cloud-bottom height. Refer to the equipment chapter in this Battlebook for additional detail.

Figure 2-D: Yield Estimates (KTs) for Illumination Times (seconds)

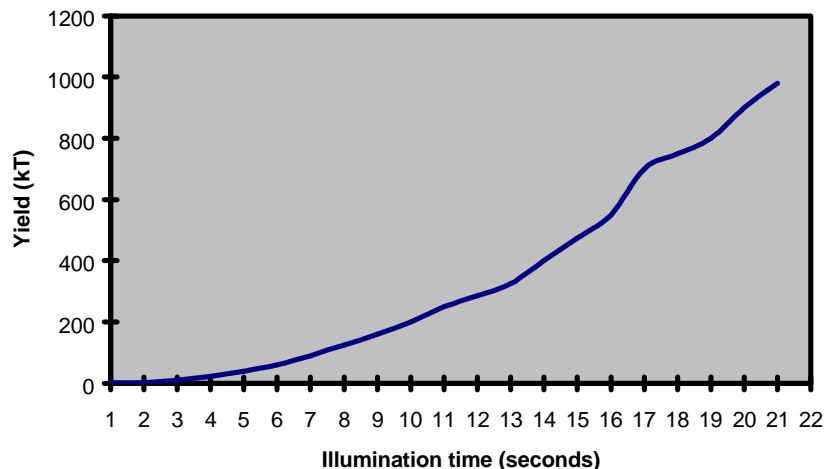

Reference: Table 3-1 from FM 3-3-1.

C. If using the cloud parameter method is not possible, a simple way to determine the yield is to use the illumination time (Figure 2-D). This yield estimation method only gives an estimate on the order of a factor-of-ten. Under no circumstances should the observer look directly at the fireball. This will cause permanent damage to the eyes. Observers can sense, with eyes closed, when the intense light has faded. An observer in a foxhole can look at the floor of the foxhole. Counting procedure is the same as that for flash-to-bang time. The person counting illumination time stops counting when the light begins to fade.

2.8. Radiation from a Detonation

1. Reference: FM 8-9 (Part I).

Table 2-M: Typical Neutron Dose-to-Total Dose Ratios

Yield (KT)	Neutron/gamma	Neutron/total dose	Range (meters)
0.1	4.6	0.82	360
1.0	3.0	0.75	650
10.0	1.6	0.62	1040
100.0	0.47	0.32	1500
1000.0	0.042	0.04	2280
Assumptions: The height of burst is $60 * W^{1/3}$ meters, where W = yield in kilotons; air density is equal to 0.9, relative to sea level; fission only device			

Reference: Table 2-III from FM 8-9 (Part I).

2. General. A nuclear burst results in four types of ionizing radiation: neutron, gamma, beta, and alpha. Neutrons and gamma rays characterize the initial burst while the residual radiation is primarily of alpha, beta, and gamma rays. Blast and thermal injuries in many cases will far outnumber radiation injuries. However, radiation effects are considerably more complex and varied than are blast or thermal effects.
3. Initial Radiation. The range for significant levels of initial radiation does not increase markedly with weapon yield and, as a result, the initial radiation becomes less of a hazard with increasing yield. With larger weapons, above 50 KT, blast and thermal effects are so much greater in importance that prompt radiation effects can be ignored.
4. Neutrons. The initial radiation can be divided into two components, neutrons and gamma rays. As a general rule, the neutron-to-gamma ratio decreases with the range from the weapon's ground zero. The ratios for vehicles and shelters depend on the specific neutron and gamma protection factors associated with the vehicle or shelter. For a tank, the protection factors are about 2 and 10 for neutrons and gammas, respectively.
5. Residual Radiation. The residual radiation hazard from a nuclear explosion is radioactive fallout and neutron-induced activity.

A. Fission Products. These are intermediate weight isotopes that are formed when a heavy uranium or plutonium nucleus is split in a fission reaction. There are over 300 different fission products with widely differing half-lives. Some half-lives are long enough that the materials can be a hazard for months or years. Their principal mode of decay is by the emission of beta and gamma radiation. Approximately 60 grams of fission products are formed per kiloton of yield.

The estimated activity of this quantity of fission products 1 minute after detonation is equal to that of 1.1×10^{21} Bq.

B. Unfissioned Nuclear Material. Nuclear weapons are relatively inefficient in their use of fissionable material. The explosion disperses much of the uranium and plutonium without undergoing fission.

C. Neutron-Induced Activity. If nuclei capture neutrons when exposed to neutron radiation, they will, as a rule, become radioactive and then decay by emission of beta and gamma radiation over an extended period of time. Neutrons emitted as part of the initial nuclear radiation will cause activation of the weapon residues and environmental material, such as soil, air, and water. For example, a small area around ground zero may become hazardous as a result of exposure of the minerals in the soil to initial neutron radiation, due principally to neutron capture by sodium, manganese, aluminum, and silicon in the soil. This is a negligible hazard because of the limited area involved.

D. Local Fallout.

(1) In a surface burst, large amounts of earth or water will be vaporized by the heat of the fireball and drawn up into the radioactive cloud. This material will become radioactive when it condenses with fission products and other radio-contaminants or has become neutron-activated. There will be large amounts of particles of less than 0.1 micrometer to several millimeters in diameter generated in a surface burst in addition to the very fine particles that contribute to worldwide fallout. The larger particles will not rise into the stratosphere but will settle to earth within about 24 hours as local fallout. Severe local fallout contamination can extend far beyond the blast and thermal effects, particularly in the case of high yield surface detonations. Whenever individuals remain in a radiological contaminated area, such contamination will lead to an immediate external radiation exposure as well as a possible later internal hazard due to inhalation and ingestion of radio-contaminants. In severe cases of fallout contamination, lethal doses of external radiation may be incurred if protective or evasive measures are not undertaken.

(2) In cases of water surface bursts, the particles tend to be rather lighter and smaller producing less local fallout but extending over a greater area. The particles contain mostly sea salts with some water; these can have a cloud seeding affect causing local rainout and areas of high local fallout.

(3) For subsurface bursts, there is an additional phenomenon present called "base surge." The base surge is a cloud that rolls outward from the bottom of the column. For underwater bursts the visible surge is a cloud of water droplets with the property of flowing almost as if it were a fluid. After the water evaporates, an invisible base surge of small radioactive particles may persist. For subsurface land bursts, the surge is made up of small solid particles, but it still behaves like a fluid. A soil earth medium favors base surge formation in an underground burst.

(4) Meteorological Effects. Meteorological conditions will greatly influence fallout, particularly local fallout. Atmospheric winds are able to distribute fallout over large areas. For example, as a result of a surface burst of a 15 MT thermonuclear device at Bikini Atoll, a roughly cigar-shaped area of the Pacific extending over 500 km downwind and varying in width to a maximum of 100 km was severely contaminated. Snow and rain will accelerate

local fallout. Under special meteorological conditions, such as a local rain shower that originates above the radioactive cloud, limited areas of heavy contamination may be formed.

6. Electromagnetic Pulse (EMP). Nuclear detonations produce an electromagnetic pulse that can interfere with electronics such as computers and medical life-support systems. Strength and radius of EMP pulse is dependent on type of burst and yield of weapon. Significant EMP only occurs with ground and high-altitude bursts. If warned of a nuclear detonation, one can prevent damage from EMP by turning off the equipment and, in some cases, burying the equipment in the ground.

2.9. Medical Effects from A Nuclear Detonation

1. References: FM 3-7, FM 8-9 (Chapter 4 of Part I), and FM 8-10-7 (Section 2).
2. General. The physiological effects of nuclear weapons result from the direct physical effects from the blast, the thermal radiation, the ionizing radiation (initial or residual), or a combination. Injuries from the ionizing radiation are covered in a later section. For weapons less than 10 KT, ionizing radiation is the primary creator of casualties requiring medical care. For weapons greater than 10 KT, thermal radiation is the primary cause of injury.
3. Blast Injuries. There are two types of blast forces that occur in a nuclear detonation blast wave: direct blast wave overpressure forces and indirect blast wind drag forces. The most important blast effects, insofar as production of casualties will be those due to the blast wind drag forces. Casualties requiring medical treatment from direct blast effects are produced by overpressures between 1.0 and 3.5 atmospheres. However, other effects (such as indirect blast injuries and thermal injuries) are so predominate that patients with only direct blast injuries make up a small part of the patient workload.

A. Direct Blast Injury. The human body is remarkably resistant to static overpressure, particularly when compared with rigid structures such as buildings. Overpressures that are sublethal can cause lung damage and eardrum rupture. Eardrum rupture will be the most common injury from overpressure. Direct blast effects can contribute significantly to the immediate deaths and injuries sustained close to the point of detonation and can constitute an important total casualty producing effect in the large area of lethal damage associated with a given nuclear detonation. Personnel in fortifications or heavy vehicles such as tanks who are protected from radiation and thermal and blast wind effects may be subjected to complex patterns of direct overpressures since blast waves can enter such structures and be reflected and reinforced within them.

B. Indirect Blast Wind Drag Forces. Indirect Blast Wind Drag Forces. The drag forces (indirect blast) of the blast winds are proportional to the velocities and duration of the winds. The winds are relatively short in duration, but can reach velocities of several hundred kilometers per hour. Injury can result either from flying objects impacting on the body, or from the physical displacement of the body against objects and structures. Because of the violence of the winds associated with even low values of overpressure, mechanical injuries due to flying objects sent into motion by the winds or to violent bodily translation will far outnumber direct blast injuries due to actual compression of the organism. Certain terrain, such as desert, is particularly susceptible to flying object forming effects of winds. However, the drag forces of the blast winds

produced by nuclear detonations are so great that almost any form of vegetation or structure will be broken apart into a variety of flying objects. As a result, large numbers and a great variety of flying objects will be generated in almost any environment. Varied flying object injuries will be common. The drag forces of the blast winds are strong enough to displace even large objects such as vehicles or to cause collapse of large structures such as buildings. These can result in very serious crush injuries. Depending upon the intensity of the drag forces and the nature of the environment, humans themselves can become a flying object and be displaced to variable distance and at variable velocities.

4. **Biological Effects of Thermal Radiation.** The thermal radiation emitted by a nuclear detonation causes burns in two ways: by direct absorption of the thermal energy through exposed surfaces (flash burns); or by the indirect action of fires in the environment (flame burns). Indirect flame burns can easily outnumber all other types of injury.

A. **Flash Burns.** Thermal radiation travels outward from the fireball in a straight line; therefore, the thermal intensity available to cause flash burns decreases rapidly with distance. Close to the fireball, all objects will be incinerated.

B. **Clothing.** The battle-dress uniform, mission-oriented protective posture (MOPP) gear, or any other clothing will provide significant additional protection against flash burns. Clothing significantly impedes heat transfer and may prevent or reduce the severity of burns, depending on the magnitude of the thermal flux.

C. **Indirect (flame) Burns.** Indirect or flame burns result from exposure to fires caused by the thermal effects in the environment, particularly from ignition of clothing. This could be the predominant cause of burns depending on the number of and characteristics of flammable objects in an environment. This is particularly true for the large yield weapons, which can cause firestorms over extensive areas.

Figure 2-E: Flashblindness and Retinal Burn Safe Separation

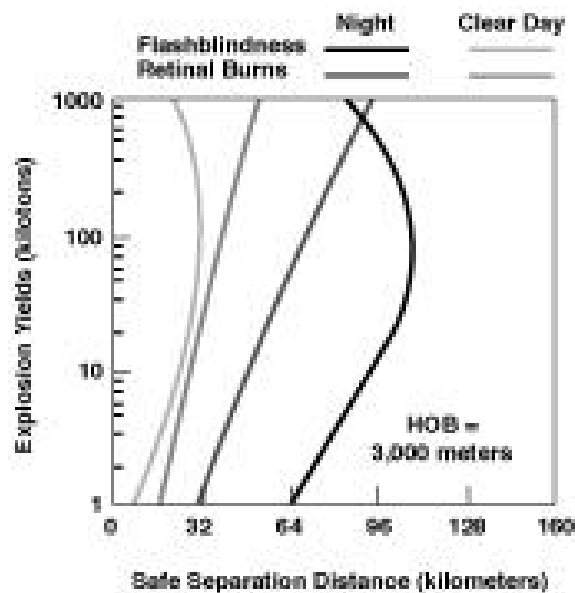

Reference: Figure 4-I, FM 8-9

D. Eye Injuries. The initial thermal pulse can cause eye injuries in the forms of flash blindness and retinal scarring. The initial brilliant flash of light produced by the detonation causes flash blindness. This flash swamps the retina, bleaching out the visual pigments and producing temporary blindness. During daylight hours, this temporary effect may last for about 2 minutes. At night, flash blindness will affect personnel at greater ranges and for greater duration. Partial recovery can be expected in 7 minutes, though it may require 30 minutes for full night adaptation recovery. Retinal scarring is the permanent damage from a retinal burn. It will occur only when the fireball is actually in the individual field of view and should be a relatively uncommon injury. The retinal burn safe separation distance is approximately 20-km during the day and 50-km at night. See the below figure for more detail.

2.10. Psychological Aspects of Nuclear Weapons

It is difficult to predict the numbers and types of psychiatric patients. It is generally felt that the types of acute psychological problems which would occur in such circumstances would be essentially the same as those seen in other combat situations, and that the treatment methods which have been developed as a result of experience in past wars would be appropriate. See Chapter 6, Section VI of Part I of FM 8-9 for more complete description.

2.11. Radiosensitivity of Various Organs

1. Reference: Chapter 5 from FM 8-9 (Part I).

Table 2-N: Relative Radiosensitivity of Various Organs

Organs	Relative radiosensitivity	Chief mechanism of parenchymal hypoplasia
The hematopoietic and the gastrointestinal systems	High*	Destruction of parenchymal cells, especially the vegetative or differentiating cells
Skin; cornea & lens of eyes; gastrointestinal organs; cavity, esophagus, stomach, rectum	Fairy high	Destruction of vegetative and differentiating cells of the stratified epithelium
Growing cartilage; the vasculature; growing bones	Medium	Destruction of proliferating chondroblasts or osteoblasts; damage to the endothelium; destruction of connective tissue cells & chondroblasts or osteoblasts
Mature cartilage or bone; lungs; kidneys; liver; pancreas; adrenal gland; pituitary gland	Fairly low	Hypoplasia secondary damage to the fine vasculature and connective tissue elements
Muscle; brain; spinal cord	Low	Hypoplasia secondary damage to the fine vasculature and connective tissue elements, with little contribution by the direct effects on parenchymal tissues

*Embryonic tissue is also highly radiosensitive

Reference: Table 5-IV from FM 8-9 (Part I).

2. **Relative Organ Radiosensitivity.** In general, actively dividing cells are most sensitive to radiation. Additionally, radiosensitivity tends to vary inversely with the degree of differentiation of the cell.
3. **Bone-Marrow Kinetics.** The bone marrow contains three cell renewal systems: the erythropoietic (red cell), the myelopoietic (white cell), and the thrombopoietic (platelet). The time cycles and cellular distribution patterns and postirradiation responses of these three systems are quite different. The erythropoietic system has a marked propensity for regeneration following irradiation from which survival is possible. After sub-lethal exposures, marrow erythropoiesis normally recovers slightly earlier than granulopoiesis and thrombopoiesis and occasionally overshoots the base-line level before levels at or near normal are reached. Recovery of myelopoiesis lags slightly behind erythropoiesis and is accompanied by rapid increases in numbers of differentiating and dividing forms in the marrow. The thrombocytopoiesis normally regenerates at a slower rate than both erythropoiesis and myelopoiesis after sub-lethal exposures.
4. **Gastrointestinal Kinetics.** Because of the high turnover rate occurring within the stem cell and proliferating cell compartment of the crypt, marked damage occurs in this region by whole-body radiation doses above the mid-lethal range. Destruction as well as mitotic inhibition occurs within the highly radiosensitive crypt and proliferating cell compartments within hours after high doses.

2.12. Systemic Effects of Whole-Body Irradiation

1. **References:** FM 3-7, FM 8-9 (Part I), and FM 8-10-7.
2. **General.** The median lethal dose of radiation that will kill 50 percent of the exposed persons within a period of 60 days, without medical intervention (designated as LD50/60), is approximately 450 cGy. Medically, other figures of interest are the dose that will kill virtually no one, (LD5), and the dose that will kill virtually every one (LD95). Approximations of those doses are within the ranges 200-300 cGy (free in air) and 600-700 cGy (free in air), respectively.
3. **Battlefield.** For yields of 5-10 KT (or less), initial nuclear radiation is the dominant casualty producer on the battlefield. Military personnel receiving an acute incapacitation dose (30 Gy) will become performance degraded almost immediately and combat ineffective within several hours. However, they will not die until 5-6 days after exposure if they do not receive any other injuries that make them more susceptible to the radiation dose. Soldiers receiving less than a total of 150 cGy will remain combat effective. Between those two extremes, military personnel receiving doses greater than 150 cGy will become degraded; some will eventually die. A dose of 530-830 cGy is considered lethal without medical treatment but not immediately incapacitating. Personnel exposed to this amount of radiation will become performance degraded within 2-3 hours, depending on how physically demanding the tasks they must perform are, and will remain in this degraded state at least 2 days. Adequate provision of medical care during this time frame should reduce mortality to less than ten percent. If medical care is not provided, these personnel will experience a recovery period and be effective at performing non-demanding tasks for about 6 days, after which they will relapse into a degraded state of performance and remain so for about 4 weeks. At this time they will begin exhibiting radiation symptoms of sufficient severity to render them totally ineffective. Death follows at approximately 6 weeks after exposure. Partial body shielding reduces the behavioral effects of radiation.

4. Whole-body Irradiation. Whole-body irradiation, where absorbed doses are high and acquired over short periods of time, will result in acute radiation sickness. There are three characteristic syndromes that make up the typical clinical pattern of acute radiation sickness. These are the hematopoietic, gastrointestinal, and neurovascular syndromes which occur with increasing dose, respectively.
 - A. Hematopoietic Syndrome. Patients who have received doses of radiation in the low to mid-lethal range will have depression of bone-marrow function with cessation of blood-cell production leading to pancytopenia. Among treated patients, deaths should be minimal.
 - B. Gastrointestinal Syndrome. The doses of radiation that will result in the gastrointestinal syndrome are higher than those causing the hematopoietic syndrome. An acute dose which will cause this syndrome would be at least 800 cGy measured in air. The gastrointestinal syndrome has a very serious prognosis because it is almost always accompanied by non-recoverable bone marrow. The onset of the clinical phase of the gastrointestinal syndrome occurs earlier than that of the hematopoietic syndrome. After a short latent period of a few days to a week or so, the characteristic severe fluid losses, hemorrhage, and diarrhea begin.
 - C. Neurovascular Syndrome. The neurovascular syndrome is associated with absorbed doses in the supralethal range and would be seen quite rarely since heat and blast effects would cause immediate lethality in most situations where the required very high radiation doses would be sustained. Exceptions could occur in aircrews exposed to prompt nuclear radiation from high altitude detonations and personnel protected against heat and blast in hardened sites below the surface or personnel in vehicles or shelters in the proximity of enhanced weapons' detonations. The latent period is very short varying from several hours to 1 to 3 days.
5. Clinical Course of Radiation Sickness. The three syndromes described follow a similar clinical pattern that can be divided into three phases: an initial or prodromal phase occurring during the first few hours after exposure; a latent phase, which becomes shorter with increasing dose; and the manifest phase of clinical illness.
 - A. Prodromal Phase. The initial phase of prodromal symptoms is characterized by the relatively rapid onset of nausea, vomiting, and malaise. This is a nonspecific clinical response to acute radiation exposure. It is not diagnostic of the degree of radiation injury; however, in the absence of associated trauma and an early onset, it does suggest a large radiation exposure. The duration of this prodromal phase is short, generally a few hours, and the incapacitation should not be severe enough to warrant evacuation of military personnel away from their units.
 - B. Latent Phase. Following recovery from the prodromal phase, the exposed individual will be relatively symptom-free during the latent phase. The length of this phase varies with the dose. The latent phase is longest preceding the hematopoietic syndrome and may vary between 2 and 6 weeks. It is somewhat shorter prior to the gastrointestinal syndrome, lasting a few days to a week. It is shortest preceding the neurovascular syndrome, lasting only hours. Because of the extreme variability in duration of the latent phase, it is not practical to hospitalize all personnel suspected of having radiation injury early in the latent phase unless radiation injury has been diagnosed. Instead, it is reasonable to wait until the onset of clinical illness or the development of hematopoietic suppression as indicated by the individual's peripheral blood profile.

C. Manifest Phase. This phase presents with the clinical symptoms associated with the major organ system injured (marrow, intestine, neurovascular system). A summary of essential features of each syndrome and the doses at which they would be seen in young healthy adults exposed to short, high dose single exposures is shown in Figure 6-I of Part I of FM 8-9.

6. Symptoms. These symptoms frequently occur in whole-body irradiated casualties within the first few hours of postexposure.

A. Nausea and Vomiting. Nausea and vomiting occur with increasing frequency as the radiation exceeds 100-200 cGy. Their onset may be as long as 6-12 hours postexposure, but usually subside within the first day. The occurrence of vomiting within the first 2 hours is usually associated with a severe radiation dose. Vomiting within the first hour, especially if accompanied by explosive diarrhea, is associated with fatal doses. Due to the transient nature of these symptoms, it is possible that the patient will have already passed through the initial phase of gastrointestinal distress before being seen.

B. Hyperthermia. Casualties who have received a potentially lethal radiation injury show a significant rise in body temperature within the first few hours postexposure. The occurrence of fever and chills within the first day postexposure is associated with a severe and life-threatening radiation dose. Hyperthermia may occur in patients who receive lower but still serious radiation doses (200 cGy or more). Individuals wearing a chemical ensemble will normally be hyperthermic; consequently, this will not be a useful sign.

C. Erythema. A person who received a whole-body dose of more than 1000-2000 cGy will develop erythema within the first day postexposure. This is also true for those who received comparable doses to local body regions. In this case, the erythema is restricted to the affected area. With doses lower but still in the potentially fatal range (200 cGy or more), erythema is less frequently seen.

D. Hypotension. A noticeable decline in systemic blood pressure has been recorded in victims who received a lethal whole-body radiation dose. In persons who received several hundred cGy, a drop in systemic blood pressure of more than 10% has been noted. Severe hypotension after irradiation is associated with a poor prognosis.

E. Neurologic Dysfunction. Experience indicates that almost all persons who demonstrate obvious signs of damage to the central nervous system within the first hour postexposure have received a lethal dose. Symptoms include mental confusion, convulsions, and coma. Intractable hypotension will probably accompany these symptoms. Despite vascular support, these patients succumb within 48 hours.

2.13. Management of Radiation Casualties

1. References: FM 8-9 (Part I) and FM 8-10-7.
2. Diagnosis. The diagnosis of radiation sickness is based primarily upon the clinical picture presented by the patient. A precise history of exposure may be very difficult to obtain. Dosimetry will not give adequate information to determine either the extent of radiation injury or the prognosis. Dosimeters cannot tell whether a radiation exposure is whole body or partial body. They do not tell what the dose rate of the exposure was. Finally, they cannot differentiate between single exposures and multiple exposures unless read at regular intervals. However, in the

mass casualty situation, decisions based on dosimetric data alone may be all that is practicable. The use of antiemetic drugs to prevent performance degradation will make symptom-based triage of irradiated personnel untenable. Only individual dosimeters and lymphocyte counting will be of any value in this situation.

3. Definitive diagnosis. It is difficult to establish an early definitive diagnosis. Therefore, it is best to function within a simplified, tentative classification system based on the three possible categories of patients.

A. **Radiation Injury Unlikely.** If there are no symptoms associated with radiation injury, patients are judged to be at minimal risk for radiation complications. These patients should be triaged according to the severity of the conventional injuries. If the patients are free of conventional injuries or disease states that require treatment, they should be returned to duty.

B. **Radiation Injury Probable.** Anorexia, nausea, and vomiting are the primary prodromal symptoms associated with radiation injury. Priority for further evaluation will be assigned after all life-threatening injuries have been stabilized. Casualties in this category will not require any medical treatment within the first few days for their radiation injuries. Evidence to support the diagnosis of significant radiation injury in the absence of burns and trauma may be obtained from lymphocyte assays taken over the next 2 days. If the evidence indicates that a significant radiation injury was received, these casualties need to be monitored for pancytopenic complications.

C. **Radiation Injury Severe.** These casualties are judged to have received a radiation dose that is potentially fatal. Nausea and vomiting will be almost universal for persons in this group. The prodromal phase may also include prompt explosive bloody diarrhea, significant hypotension, and signs of neurologic injury. These patients should be sorted according to the availability of resources. Patients should receive symptomatic care. Lymphocyte analysis is necessary to support this classification.

4. Lymphocyte levels. In austere field conditions, lymphocyte levels may be used as a biologic dosimeter to confirm the presence of pure radiation injury but not in combined injuries. An initial blood sample for concentrations of circulating lymphocytes should be obtained as soon as possible from any patient classified as "Radiation Injury Probable." After 24 hours, additional blood samples should be taken for comparison.

A. Lymphocyte levels in excess of $1500/\text{mm}^3$ (cubic millimeters). The patient most likely has not received a significant dose that would require treatment.

B. Lymphocyte levels between 1000 and $1500/\text{mm}^3$. The patient may require treatment for moderate depression in granulocytes and platelets within 3 weeks.

C. Lymphocyte levels between 500 and $1000/\text{mm}^3$. The patient will require treatment for severe radiation injury. The patient should be hospitalized to minimize the complications from hemorrhage and infection that will arise within 2-3 weeks postexposure.

D. Lymphocyte levels of less than $500/\text{mm}^3$. The patient has received a radiation dose that may prove fatal. The patient needs to be hospitalized for the inevitable pancytopenic complications.

E. Lymphocytes not detectable. The patient has received a super-lethal radiation dose, and survival beyond two weeks is unlikely.

F. Other Guidelines. A useful rule of thumb is, if lymphocytes have decreased by 50% and are less than 1000/mm³, then the patient has received a significant radiation exposure. In the event of combined injuries, the use of lymphocytes may be unreliable. Patients who have received severe burns or multi-system trauma often develop lymphopenia. It is important to note that individuals with concurrent viral infections would have a lymphocytosis based on their illness.

5. Triage. All combined-injury patients should be treated initially as if no significant radiation injury is present. Triage and care of any life-threatening injuries should be rendered without regard for the probability of radiation injury or contamination. The physician should make a preliminary diagnosis of radiation injury only for those patients for whom radiation is the sole source of the problem. This is based on the appearance of nausea, vomiting, diarrhea, hyperthermia, hypotension, and neurologic dysfunction.

Table 2-O: Preliminary Triage of Casualties with Possible Radiation Injuries

Symptoms	Possible category of radiation injury		
	Unlikely	Probable	Severe
Nausea	Absent	Excessive	Very Excessive
Vomiting	Absent	Present	Very Excessive
Diarrhea	Absent	Absent to Present	Absent to Very Excessive
Hyperthermia	Absent	Absent to Present	Present to Very Excessive
Hypothermia	Absent	Absent	Present to Very Excessive
Erythema	Absent	Absent	Absent to Excessive
CNS dysfunction	Absent	Absent	Absent to Excessive

Reference: Table 6-II from FM 8-9 (Part I).

Table 2-P: Radiation Doses and Combined Injuries

Starting Triage Classifications	Final Triage Classifications		
	Less than 150 cGy	150-550 cGy	Over 550 cGy
Radiation Only	Minimal or duty	Delayed**	Delayed
Immediate	Immediate	Immediate or Expectant*	Expectant
Delayed	Delayed	Delayed or Expectant*	Expectant
Minimal	Minimal	Minimal**	Expectant
Expectant	Expectant	Expectant	Expectant

*Select Expectant in the case of full or partial thickness burns coverings more than 18 % of the body surface, or trauma which would either result in significant infection or be categorized as severe but not immediately life threatening, such as a fractured femur. This is a clinical decision and not necessarily subjectively reproducible.

**Includes the probable requirements for antibiotics and transfusion at a later time. So this classification does not suggest that the patient is not in need of treatment, but rather that he does not need immediate specialized care.

Reference: Table 4-2 from FM 8-10-7 and comments from AFRRI.

6. Fatal Dose of Radiation. Casualties who have received a potentially fatal dose of radiation will most likely experience a pattern of prodromal symptoms that is associated with the radiation exposure itself. Unfortunately, these symptoms are nonspecific and may be seen with other forms of illness or injury, which may complicate the process of diagnosis.

2.14. Treatment of Radiation Injuries

1. References: FM 8-9 (Part I) and FM 8-10-7.
2. General. First actions in dealing with radiation casualties are to treat any conventional injuries first. Maintain ventilation and perfusion and stop hemorrhages. Most decontamination will be accomplished through routine management of the patient. Triage for radiation injuries followed by steps to prevent infection, fluid imbalance, electrolyte imbalance, and bleeding will be necessary after patient stabilization. Unfortunately, there are limitations in the ability to effect these treatments successfully, particularly on a large scale with limited resources.
3. Initial Treatment for Patients with Whole-Body Radiation Injury. The primary determinants of survival among most patients receiving intermediate (serious but not uniformly fatal if treated) radiation doses is stopping any bleeding, aggressive resuscitation of the bone marrow and completed by management of microbial infections. For those casualties who have received sub-lethal whole-body radiation doses, gastrointestinal distress will predominate in the first 2 days. Antiemetics (metoclopramide, dazopride) may be effective in reducing the symptoms, but present drugs available have significant side effects. Unless severe radiation injury has occurred, these symptoms will usually subside within the first day. For triage purposes, the presence of explosive diarrhea (especially bloody) is likely to be related to a fatal radiation dose. Cardiovascular support for patients with clinically significant hypotension and neurologic dysfunction should be undertaken only when resources and staff allow. These patients are not likely to survive injury to the vascular and gastrointestinal systems combined with marrow aplasia.
4. Diagnosis and Treatment of Patient with Combined Injuries. Conventional injuries should be treated first, since no immediate life-threatening hazard exists for radiation casualties who can ultimately survive. All surgery should be completed within 36-48 hours of irradiation.
5. Management of Infection. It is recommended either that the treatment continue until the granulocytes return to more than 500 or treat for just 2 weeks and stop even if the white cell count is still low, providing all signs of infection have cleared. Section 621 of Part I of FM 8-9 details the management of infection for radiological casualties.
6. Dosimetry. Dosimetry for an individual patient should only be considered as an aid to diagnosis and prognosis. The patient's clinical condition combined with appropriate laboratory investigation will better indicate the prognosis.

Table 2-Q (Part 1): Medical Response to Nuclear Radiation

Dose range (cGy free in air)	Onset and duration of initial symptoms
0 to 70	From 6 to 12 hours: none to slight incidence of transient headache and nausea; vomiting in up to 5 percent of personnel in upper part of dose range.
70 to 150	From 2 to 20 hours: transient mild nausea and vomiting in 5 to 30 percent of personnel.
150 to 300	From 2 hours to 3 days: transient to moderate nausea and vomiting in 20 to 70 percent; mild to moderate fatigability and weakness in 25 to 60 percent of personnel.
300 to 530	From 2 hours to 3 days: transient nausea and vomiting in 50 to 90 percent; moderate fatigability in 50 to 90 percent of personnel.
530 to 830	From 2 hours to 2 days: moderate to severe nausea and vomiting in 80 to 100 percent of personnel. From 2 hours to 6 weeks: moderate to severe fatigability and weakness in 90 to 100 percent of personnel.
830 to 3000	From 30 minutes to 2 days: severe nausea, vomiting, fatigability, weakness, dizziness, and disorientation; moderate to severe fluid imbalance and headache.
3000 to 8000	From 30 minutes to 5 days: severe nausea, vomiting, fatigability, weakness, dizziness, disorientation, fluid imbalance, and headache.
Greater than 8000	From 30 minutes to 1 day: severe and prolonged nausea, vomiting, fatigability, weakness, dizziness, disorientation, fluid imbalance, and headache.

Reference: Table 7-I from FM 8-9, Table 4-1 from FM 8-10-7, Table 4-10 from FM 3-7.

Table 2-Q (Part 2): Medical Response to Nuclear Radiation

Performance (mid range dose)	Medical Care and Disposition
Combat effective.	No medical care, return to duty.
Combat effective.	No medical care, return to duty.
DT: PD from 4 hours until recovery. UT: PD from 6 to 20 hours; PD from 6 weeks until recovery.	At 3 to 5 weeks: medical care for 10 to 50 %. At high end of range, death may occur to more than 10 %. Survivors return to duty.
DT: PD from 3 hours until death or recovery. UT: PD from 4 to 40 hours and from 2 weeks until death or recovery.	At 2 to 5 weeks: medical care for 10 to 80 %. At low end of range, less than 10 % deaths; at high end, death may occur for more than 50 %; survivors return to duty.
DT: PD from 2 hours to 3 weeks; CI from 3 weeks until death. UT: PD from 2 hours to 2 days and from 7 days to 4 weeks; CI from 4 weeks until death.	At 10 days to 5 weeks: medical care for 50 to 100 %. At low end of range, death may occur for more than 50 % at 6 weeks. At high end, death may occur for 99 % of personnel.
DT: PD from 45 minutes to 3 hours; CI from 3 hours until death. UT: PD from 1 to 7 hours; CI from 7 hours to 1 day; PD from 1 to 4 days; CI from 4 days until death.	1000 cGy: at 4 to 6 days medical care for 100 %; 100 % deaths at 2 to 3 weeks. 3000 cGy: at 3 to 4 days medical care for 100 %; 100 % deaths at 5 to 10 days.
DT: CI from 3 to 35 minutes; PD from 35 to 70 minutes; CI from 70 minutes until death. UT: CI from 3 to 20 minutes; PD from 20 to 80 minutes; CI from 80 minutes until death.	4500 cGy: at 6 hours to 1 to 2 days; medical care for 100 %; 100 % deaths at 2 to 3 days.
DT and UT: CI from 3 minutes until death.	8000 cGy: medical care needed immediately to 1 day; 100 % deaths at 1 day.
<p>Key: DT = Demanding Task UT = Undemanding Task CI = Combat Ineffective (less than 25% performance) PD = Performance Degraded (25 to 75% performance)</p>	

Table 2-R (Part 1): Medical Aspects of Radiation Injury in Nuclear War

Dose range (cGy)	Antiemetic Pretreatment	Indicated Medical Treatment
0 to 70	Not determined	Reassurance Counsel at redeployment
70 to 150	5-30% of personnel nauseated without emesis	Debridement and primary closure of any and all wounds. No delayed surgery
150 to 300	Decreased vomiting. Early return to duty for UT Possible increase of fatigability	Fluid and electrolytes for GI losses Consider cytokines for immunocompromised patients (Follow granulocyte counts)
300 to 530	Undetermined	Fluid and electrolytes for GI losses Consider cytokines for immunocompromised patients (Follow granulocyte counts) Specific antibiotic therapy for infections May require GI decontamination with quinolones use alimentary nutrition
530 to 830	None	Tertiary level intensive care required improving survival. Fluid and electrolytes for GI losses may require transfusion and/or colloids. Cytokines for immunocompromised patients Specific antibiotic therapy for infections, to include antifungals. Will require GI decontamination with quinolones, use alimentary nutrition
Greater than 830	None	Supportive therapy in higher dosage ranges. Aggressive therapy if pure radiation injury and some evidence of response.

Reference: AmedP-6(C) Draft from AFRRI

Table 2-R (Part 2): Medical Aspects of Radiation Injury in Nuclear War

Medical Problems
None
Potential for delayed traumatic and surgical wound healing, minimal clinical effect
Significant medical care may be required at 3-5 wks for 10-50% of personnel. Anticipated problems should include infection, bleeding, and fever. Wounding or burns will geometrically increase morbidity and mortality
Frequent diarrheal stools, anorexia, increased fluid loss, ulceration, death of crypt cells and Peyers Patch lymphoid tissue Increased infection susceptibility during immunocompromised time-frame Bleeding diathesis at 3-4 wks due to megakaryocyte loss
At 10 days to 5 weeks, 50-100% of personnel will develop pathogenic and opportunistic infections, bleeding, fever, loss of appetite, GI ulcerations, bloody diarrhea, severe fluid and electrolyte shifts, third space losses, capillary leak, hypotension
LD ₁₀₀ at 1000 cGy death at 2-3 wks. Minimal if any break between prodromal syndrome and manifest illness. At high radiation levels, CNS symptoms are predominant, with death secondary to cerebral vascular incompetence

Table 2-S (Part 1): Disposition of Radiation Injury in Nuclear War

Dose range (cGy)	Disposition Without Medical Care	Disposition Medical Care
0 to 70	Duty	Duty
70 to 150	Restricted duty. No further radiation exposure elective surgery or wounding	Restricted duty. No further radiation exposure
150 to 300	LD ₅ to LD ₁₀	Restricted duty. No further radiation exposure, elective surgery or wounding
300 to 530	LD ₁₀ to LD ₅₀ . Survivors may be able to return to light duty after 5 wks. No further radiation exposure. May require delayed evacuation from theater	Increased percentage of survivors may be able to return to duty after 5 wks. No further radiation exposure. May require evacuation from theater for adequate therapy.
530 to 830	LD ₅₀ to LD ₉₀ . At low end of exposure range, death may occur in 3-5 wks in 90%	Early evacuation to tertiary level medical center before onset of manifest illness. Patients will require extensive reverse isolation to prevent crosscontamination and nosocomial infection.
Greater than 830	LD ₉₀ to LD ₁₀₀ Expectant Category	If assets are available, then early evacuation to tertiary level medical center during manifest illness. Patient will require extensive reverse isolation to prevent cross contamination and nosocomial infection. Most patients will remain expectant.

Reference: AMedP-6(C) Draft from AFRRRI

Table 2-S (Part 2): Disposition of Radiation Injury in Nuclear War

Clinical Remarks
Mild lymphocyte depression within 24 hrs
Moderate drop in lymphocyte, platelet, and granulocyte counts. Increased susceptibility to opportunistic pathogens.
If there are more than 1.7×10^9 lymphocytes per liter 48 hrs after exposure, it is unlikely that an individual has received a fatal dose. Patients with low (300-500) or decreasing lymphocyte counts, or low granulocyte counts should be considered for cytokine therapy and biologic dosimetry using metaphase analysis where available.
Moderate to severe loss of lymphocytes. Follow counts q6h in first few days if possible for prognosis. Moderate loss of granulocytes and platelets. Hair loss after 14 days, Thrombocytopenic purpura appears after 3 wks. Consider cytokine therapy and biologic dosimetry using methphase analysis where available. Loss of crypt cells and GI barriers may allow pathogenic and opportunistic bacterial infection. Use alimentary nutrition to encourage crypt cell growth. Avoid parenteral nutrition and central intravenous lines.
Practically no lymphocytes after 48 hrs. Severe drop in granulocytes and platelets later. In pure radiation exposure scenarios, these patients will require highest priority evacuation. The latent period between prodromal symptoms and manifest illness may be very short. When this radiation injury is combined with any significant physical trauma, survival rates will approach zero. All surgical procedures must be accomplished in initial 36-48 hrs after irradiation. Any additional surgery must be delayed until 6 wks post exposure.
Bone marrow totally depleted within days. Bone marrow transplant may or may not improve ultimate outcome, due to late radiation pneumonitis and fibrotic complications. Even minor wounds may prove ultimately fatal. Aggressive therapy is indicated when resources are available and transport to a tertiary care medical center is possible.

Figure 2-F: Clinical Effects of Whole Body Irradiation in Humans

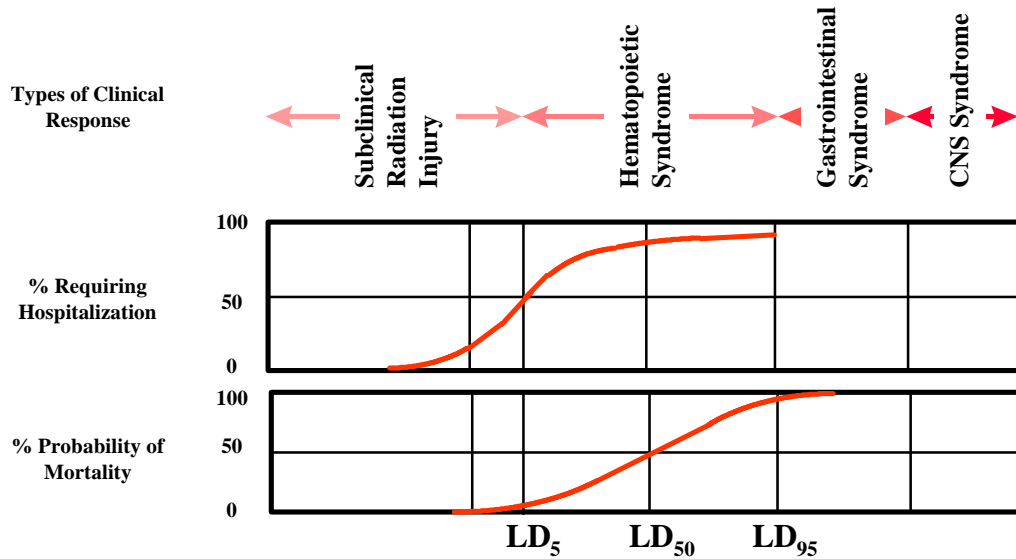

Reference: Figure 6-V from FM 8-9 (Part I).

Figure 2-G: Dose versus LD for Whole Body Irradiation

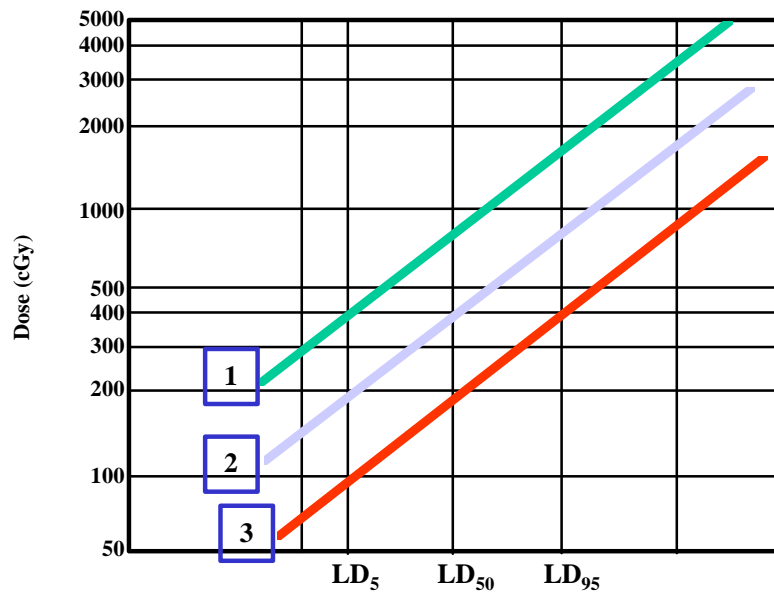

- 1 - Dose response for low dose rate exposures (fallout),
- 2 - Dose response for uncomplicated prompt exposure.
- 3 - Dose response for prompt exposure complicated by combined injury.

Reference: Figure 6-V from FM 8-9 (Part I).

3 *RADIOLOGICAL HAZARDS*

Table of Contents

3.1.	Background	3-3
3.2.	Natural Background Levels of Radiation	3-3
3.3.	Radiological Dispersal Weapons	3-4
3.4.	Nuclear Power Plants	3-4
3.5.	Industrial Sources of Radiological Hazards	3-6
3.6.	Medical Sources of Radiological Hazards	3-7
3.7.	X-ray machines and Accelerators	3-9
3.8.	Army Commodities	3-9
3.9.	General Operational Guidance	3-14
3.10.	Radioisotopes from Nuclear Weapons	3-15
3.11.	Nuclear Weapon Accident	3-16
3.12.	Hazard Predictions of Radiological Releases	3-16
3.13.	Response to Commodity Accidents	3-17
3.14.	Medical Planning Specific to Radiological Contaminated Areas	3-19
3.15.	NATO Policy on Low Level Radiological Hazards	3-21
3.16.	Contamination Limits	3-28
3.17.	Radiation Units	3-30
3.18.	Radiological Detection Equipment	3-31
3.19.	Radiological Surveys	3-32
3.20.	Dosimetry	3-35
3.21.	Bioassay	3-38
3.22.	Radiological Basics	3-38
3.23.	Internal Irradiation	3-41
3.24.	Radioactive Materials	3-43
3.25.	Delayed Effects and Risk Comparisons	3-48

List of Tables

Table 3-A:	Background Radiation Levels (external)	3-3
------------	--	-----

Table 3-B:	Radiation exposure pathways from nuclear plants _____	3-6
Table 3-C:	Industrial Sources of Radiation _____	3-7
Table 3-D:	Medical and Research Sources of Radiation _____	3-8
Table 3-E:	Commodities that contain Tritium _____	3-11
Table 3-F:	Depleted Uranium (DU) Munitions _____	3-12
Table 3-G:	Principal Radionuclides Induced in Soil _____	3-16
Table 3-H:	Approximate Yields of the Principal Nuclides per Megaton of Fission ____	3-16
Table 3-I:	Description of Radiological ROTA Cases _____	3-17
Table 3-J:	Radiological Hazard Prediction Methods _____	3-17
Table 3-K:	Line items for the ACE DIRECTIVE 80-63 _____	3-25
Table 3-L:	Guidance Low Level Radiation Operational Exposure _____	3-27
Table 3-M:	Maximum Contaminated Limits _____	3-29
Table 3-N:	Characteristics of Nuclear Radiation _____	3-40
Table 3-O:	More Characteristics of Nuclear Radiation _____	3-40
Table 3-P:	Spectrum of Radiation Limits (CentiGray) _____	3-48

List of Figures

Figure 3-A:	M1A1 Infinity Collimator (contains 10 Ci of Tritium) _____	3-10
Figure 3-B:	M1 Tank with DU Armor _____	3-12
Figure 3-C:	120mm M829 Sabot-Tracer _____	3-12
Figure 3-D:	Thermal Optics on M1 Tank _____	3-13
Figure 3-E:	Radiation Survey Techniques. Radial Plot (left) and Grid Plot (right) ____	3-33
Figure 3-F:	The Transformation of a Radionuclide over time _____	3-39

3.1. Background

1. Increased risk from radiological hazards may exist in areas where ionizing radiation levels are elevated above normal background levels. In some cases the radioactive material must be internalized in order to present a hazard to the individual. On the battlefield, the primary radiological threats are from radiological dispersal weapons, industrial and medical sources, and commodities containing radioactive material. The threat may be very localized such as a diagnostic nuclear medicine source in a single room in a hospital or wide spread environmental contamination such as the fallout from the accident at Chernobyl. The primary consequence of exposure to low levels of radiation is an increase in the risk of developing cancer in the longer-term post exposure. To minimize the threats from radiological hazards, one needs to identify the sources of the hazards, understand the health risk from the hazards, use precautions to avoid exposures, and document the situation.
2. There are several commands that provide assistance in identifying and understanding radiological hazards. The AFMIC can provide information on specific sites and hazards. For example, one would call AFMIC if they want to know if there are known radiological hazards in a specific area. USACHPPM can answer questions and provide training about the health risks for the various radiological hazards. For example one would call USACHPPM to inquire about the health risk for a commodity containing radioactive material. For measurement of radiation in deployed situations, either USACHPPM or the 520th TAML can provide assistance beyond the detection capabilities of normal field units. In some cases, a Nuclear Medical Science Officer (72A) will deploy with a Medical Group or Battalion. These officers can provide information on the identification, detection, and health risk of radiological material. The DOE, FEMA, and specialty teams such as RADCON handles accidents involving nuclear weapons (Broken Arrows). For specific information about commodities containing radioactive material, contact the license manager for that item. TB 43-0116 lists radioactive/commodities in the system.

3.2. Natural Background Levels of Radiation

1. Reference: USACHPPM's TG 238 and ACALA's *Radioactive Material Handling Safety*.
2. Unlike many chemical and biological agents, radiation and radiological material exist naturally. On average, U.S. citizens received 0.350 cGy of radiation per year. This number includes both external radiation sources such as cosmic radiation and radiation that we internalize through ingestion and inhalation such as radon. The background radiation level is fairly constant over the world, being 8×10^{-6} to 15×10^{-6} cGy/hr; however, there are some areas that have higher levels. Higher radiation levels are most commonly due to high concentrations of radioactive minerals in soil.

Table 3-A: Background Radiation Levels (external)

Location	Levels (cGy/yr)
New York City	0.091
Denver	0.172
Guarapari, Brazil	0.640

Reference: ACALA's *Radioactive Material Handling Safety*

3.3. Radiological Dispersal Weapons

1. Reference. USACHPPM's TG 238 and FM 100-5 (Draft).
2. Radiological weapons also referred to as radiation dispersal weapons (RDWs), spread radioactive material contaminating personnel, equipment, and terrain. Unlike a nuclear weapon, the radiological weapon does not release the radioactivity in a massive burst of energy. Rather, the radiological weapon acts like a toxic chemical in which the cumulative dose of radiation eventually proves harmful or fatal. The advantage of these weapons over nuclear devices is that nuclear technology is not required. Anyone with access to radioactive material can make one. Radioactive contaminants can be delivered by a variety of means including human agent, missile, aircraft, artillery, or the destruction of a facility or vessel containing radioactive material. The simplest RDW is radioactive material placed near or in the path of troops.
3. Radiological weapons are primarily terror and area denial weapons. Because of the time required to accumulate a disabling dose of radiation through ingestion, inhalation, or exposure, radiological weapons have limited tactical utility, except as obstacles. Their value to an enemy is their psychological effect on civilians and soldiers. These weapons may have a secondary effect on operations by compelling US commanders to divert resources to decontamination and support of civil authorities.
4. Potential sources for RDWs include hospital radiation therapy (Cobalt-60, Cesium-137), nuclear power fuel rods (Uranium-235, Plutonium), universities and laboratories and radiography and gauging (Cobalt-60, Cesium-137, Iridium-192, Radium-226). Unclassified sources reveal that the Iraqis and Russian separatists in Chechnya have already demonstrated practical knowledge of RDWs. The availability of material to make RDWs will inevitably increase in the future as more countries pursue nuclear power (and weapons) programs and radioactive material becomes more available.
5. There are no official casualty predictions for RDWs. Because of the nature of the weapon, verification of the use of the weapons may prove difficult.

3.4. Nuclear Power Plants

1. Reference: USACHPPM's TG 238 and IAEA's *Summary report on the post-accident review meeting on the Chernobyl accident*.
2. Nuclear power plants and the fuel processing cycle may pose a threat to deployed troops. When possible, troops should be located away from such sites. Information on the location and status of nuclear power plants can be found at:
 - A. <http://www.cannon.net/~gonyeau/nuclear/index.htm>
 - B. <http://www.insc.anl.gov/> (International Nuclear Safety Center (INSC))
 - C. <http://www.uic.com.au/> (Uranium Information Center)
 - D. <http://www.uilondon.org/netpower.html> (Reactor status and the net power worldwide).
 - E. <http://www2.ijs.si/~icjt/npplist.html> (Contains pictures of most of the power plants).

3. Mining and ore processing. The nuclear fuel cycle is the cycle of uranium in the process of producing electricity via nuclear power plants. Uranium is mined in a number of countries in both open pit and underground mines. The ore undergoes several processing operations and conversions before it can be used in the reactors.
4. Reactors. There are a number of different types of nuclear reactors. In the US and NATO nations, most reactors will have a large dome for containment and cooling towers. Reactors built elsewhere may look more like large warehouses or factories. The heat generated in a nuclear reactor is used to produce steam and drive turbines connected to electricity generators. Therefore, most reactors are near water. Fuel removed from a reactor, after it has reached the end of its useful life, can be reprocessed to produce new fuel. The various activities associated with the production of electricity from nuclear reactions collectively form the nuclear fuel cycle. The cycle includes mining, milling, conversion, enrichment, fuel fabrication, reactor operations, and disposal of waste. The next several photographs are provided to help one identify nuclear reactors.
5. Spent fuel. Spent fuel is generally held in the storage pools for a minimum of about five months. A minimum cooling period of 150 days is generally required and commonly used as a point of reference in light water reactors. The main objective of the 150-day cooling period is to allow for substantial decay of Iodine-131. Iodine is readily volatile and release to the environment must be minimized. After the 150-days of cooling, the major contributors to the radioactivity of spent fuel are strontium, zirconium, niobium, ruthenium, cesium, and some rare earth elements.
6. Radiological Hazards. Nuclear reactors produce several potentially dangerous radioactive materials. Iodine-131 and Iodine-133 are produced in relatively large yield in uranium fission and can be taken up by the thyroid. Cesium-134 and Cesium-137 are also produced in significant amounts in fission. Cesium becomes uniformly distributed throughout the body and becomes a beta-gamma source irradiating all organs. Cesium can enter the body by consuming water, milk, or fish from the vicinity of the liquid effluent discharge of the plant. The internal (lung) dose from inhalation of radioactive isotopes of noble gases, which may be found as part of airborne effluents, is very small. If adequate holdup is provided before release to the atmosphere, exposure to short-lived noble gases, such as Xenon-133 and Krypton-88 can be minimized during normal operations. However, long-lived Krypton-85 may cause significant exposure if there is atmospheric accumulation. Gaseous and liquid effluents contain tritium. However, tritium can accumulate in the environment, as Krypton-85 does. The whole body dose from tritium would depend on the amount deposited in the body, which can be directly related to the concentration found in the food (including milk) and water consumed.
7. Medical Response. If nuclear power plants are identified as a threat to the AOR, medical operation personnel should undertake the following efforts. First, medical units must develop local procedures to treat, decontaminate, and transport contaminated patients. Second, medical units should look at the repositioning or availability of potassium iodine for blocking uptake by I-131 to the thyroid. The use of potassium iodine should be cleared with the command surgeon. US government personnel and their dependents should be included in the plan. Third, the J-5 cell of the task force for the area is usually responsible for hazard predictions and that analysis. The medical community must work with this cell to ensure that they are aware of the hazards and contingency plans have been made. These plans should be trained and exercised. Concerns to be aware of during the exercises are movement of US forces in the plume area, the flow of patients out of the contaminated area, and the spread of contamination.

Table 3-B: Radiation exposure pathways from nuclear plants

Radionuclide	Effluent	Exposure Pathway	Critical Organ
Iodine	Airborne	Ground deposition (external)	Whole body
		Air inhalation	Thyroid
		Grass →cow → milk	Thyroid
		Leafy vegetables	Thyroid
	Liquid	Drinking water	Thyroid
		Fish (and shellfish consumption)	Thyroid
Tritium	Airborne	Submersion (external)	Skin
		Air inhalation	Whole body
	Liquid	Drinking water	Whole body
		Food consumption	Whole body
Cesium	Airborne	Ground deposition (external)	Whole body
		Grass →cow →milk or meat	Whole body
		Inhalation	Whole body
	Liquid	Sediments (external)	Whole body
		Drinking water	Whole body
		Fish consumption	Whole body
Metals (iron, cobalt, nickel, zinc, manganese)	Liquid	Drinking water	GI tract
		Fish consumption	GI track
Direct radiation from plant		External	Whole body

Reference: USACHPPM's TG 238.

3.5. Industrial Sources of Radiological Hazards

1. Reference. AFMIC's *Identification of Radiation Sources in a Peacetime Environment*, Shleien 1983, Shleien 1992, and USACHPPM's TG 238.
2. The table below gives a brief summary of locations and sources that may be involved in potential radiation exposures. For more detail, please refer to the reference document.
3. Low-Level Radioactive Waste Disposal. Low-level radioactive waste is produced by users of radioactive materials, including hospitals, research laboratories, universities, manufacturers, and nuclear power plants. Nuclear power plants produce most of the volume and radioactivity of low-level radioactive waste. All low-level waste is solid. It consists of common, everyday items such as protective clothing, gloves, supplies, and tools that have come in contact with radioactive materials. It does not include used fuel from nuclear power plants. The level of radioactivity in almost all low-level waste decays to background levels within weeks, months, or years. A small percentage stays radioactive for about 500 years.

Table 3-C: Industrial Sources of Radiation

Locations and Materials	Radiation Sources	Source Strength	Comments
Gauges, Sources, Static Eliminators	Iridium-192, Cesium-137, Cobalt-60, Radium-226, neutrons, Americium-241, Polonium-210	Greater than about 4 TBq	Sealed sources, and if leaking, surface contamination.
X-ray Machine Sterilizers, Processors, and Particle Accelerators	X-rays, protons, deuterons, electrons, gammas, Cesium-137, Cobalt-60	~4 TBq to ~40PBq	Anywhere in an industrial area. Be aware of possible activation products.
Mineral Extraction and Processing – including phosphate fertilizers, oil, natural gas, and coal.	Naturally Occurring Radioactive Materials - Uranium, Thorium, and progeny	Generally low level with external exposures from background to about 0.01mSv (1 mrem)	Dispersed low level material and scale buildup in piping. Also, gauges as noted above. It is possible for radon to be of concern.
Power Sources	Plutonium-238, Strontium-90	Plutonium-238: up to 4 GBq Strontium-90: up to 1 TBq	In equipment in isolated areas.
Radioluminescent Materials	Promethium-147, Tritium, Radium-226	Up to tens of TBq	Various areas, and if leaking, surface contamination.

Reference: Shleien 83, Shleien 92.

3.6. Medical Sources of Radiological Hazards

1. Reference. AFMIC's *Identification of Radiation Sources in a Peacetime Environment*, Shleien 83, Shleien 92, and USACHPPM's TG 238.
2. Biomedical sources of radiation are readily available at hospitals and some laboratories and present a hazard if exposure to individuals occurs or if they are dispersed to the environment. The table below gives a brief summary of locations and sources that may be involved in potential radiation exposures. For more detail, please refer to the reference document.
3. Iodine-125 sources. Iodine-125 is widely used for permanent implants in radiotherapy. The encapsulation consists of a 0.05 mm thick titanium tube welded at both ends to form a cylindrical capsule of dimensions 4.5 x 0.8 mm. Iodine-125 decays exclusively by electron capture to an excited state of Technetium-125, which then emits a 35.5 keV photon. Characteristic x-rays in the range of 27 to 35 keV also are produced due to the electron capture and internal conversion processes.

4. Cobalt-60. A typical teletherapy Cobalt-60 source is a cylinder of diameter ranging from 1.0 to 2.0 cm and is positioned in the cobalt unit with its circular end facing the patient. The sourcehead houses the source. The Gamma Knife is another type of Cobalt-60 that contains hundreds of sources in the collimator helmet. Each radiation source is composed of Cobalt-60 pellets that are contained in double stainless steel capsules with welded closures.
5. Radium. The radium source used in brachytherapy uses mostly radium sulfate or radium chloride mixed with an inert filler and loaded into cells about 1 cm long and 1 mm in diameter. These cells are made of 0.1- to 0.2- mm-thick gold foil. Radium sources are manufactured as needles or tubes in a variety of lengths and activities. Leakage of radon gas from a radium source represents a significant hazard if the source is broken. The sources are, however, doubly encapsulated to prevent such an occurrence. Cesium-137 has replaced radium, at least in the US.

Table 3-D: Medical and Research Sources of Radiation

Locations and Materials	Radiation Sources	Source Strength	Comments
Cancer Treatment Areas	Cobalt-60 and Cesium-137	~1 to several 10 Gy over several hours at about one meter if the source is exposed.	Found in therapy rooms.
Sources and Applicators	Cesium-137, Iridium-192, Radium-226, Phosphorous-32, Strontium-90, Iodine-125	Tens of MBq	Therapy and nuclear medicine areas.
Radiopharmaceuticals	Iodine-131, Iodine-123, Technetium-99 ^m , Thallium-201, Xenon-133	Tens of MBq	Storage, nuclear medicine areas and transportation.
X-ray Machines and Accelerators	X-rays and Electrons	~0.01 Gy min ⁻¹ at the source	Radiology or therapy rooms.
Various Sources and Devices	Tritium, Carbon-14, Sodium-22, Sodium-24, Sulfur-35, Calcium-45, Cobalt-60	Up to tens of TBq	Various areas, and if leaking, surface contamination.
Particle Accelerators	X-rays, alphas, protons, deuterons, electrons, gammas	~4 TBq to ~ 40PBq	Anywhere in an industrial area. Be aware of possible activation products.
Experimental Reactors and Critical Assemblies	Fission products, neutrons, fissile and fissionable material, transuranics	Up to tens of TBq	Various areas, up to square kilometers in the case of widespread contamination.

Reference: Shleien 83, Shleien 92.

3.7. X-ray machines and Accelerators

X-ray units and accelerators produce x-rays only when the exposure switch is engaged. As soon as the switch is released, or the pre-set exposure time is reached, x-ray production ends. Unless the equipment is operational at the moment of possible exposure, these machines present no potential harm to soldiers. Some high-energy accelerators may produce activation products, but most of these have short half-lives.

3.8. Army Commodities

1. Reference: USACHPPM's TG 238 and ACALA's *Radioactive Material Handling Safety*.
2. Identification. This section is for the IDENTIFICATION of radioactive sources only. The hazards of the given isotopes are covered later in the chapter. Further information on specific items of interest may be found in TB 43-0116, Identification of Radioactive Items in the Army, as well as AST-1500Z-100-93, Identification Guide for Radioactive Sources in Foreign Materiel. TB 43-0116 includes item NSNs, end-item NSNs, specific isotope and activity present, and the inventory control point (in most cases, this number indicates the license holder for that commodity). The foreign material document contains physical data on the description, location, and radioactive sources in the items.
3. Accidents. Any incidents involving radioactive sources should be reported to the unit's radiation safety officer (RSO). They should inform the license manager the incidents.
4. Disposal. For additional information about commodities contact the Industrial Operations Command (IOC). IOC has been designated as the responsible command for the safe disposal of all unwanted, low-level radioactive material in the US Army. Specifically, the IOC's Radioactive Waste Disposal office (AMSMC-RW) has been appointed the Program Manager. AMSMC-RW is accountable for providing information and guidance to all US Army "generators" of unwanted radioactive material to prevent violation of Federal and State regulations, thereby assuring safe and legal transport and burial of the material. A "radioactive waste generator" can be a DS maintenance shop, depot, etc. In all cases the post RSO or Safety Officer should be made aware that there is radioactive waste.
5. Fire Control Devices. The fire control devices used with mortars, howitzers, and tanks use tritium sources to illuminate them in low light conditions.

A. A single howitzer can have 6 or more fire control devices, each of which can contain several tritium light sources. The fire control devices that contain the most tritium are collimators and aiming lights. These items must be visible from a distance of several meters. In all cases, the equipment and its carrying case should have warning labels attached. A number of accidents have occurred when tritium sources were damaged by attempting to purge them using a high pressure purging kit. Some of the doses received during these accidents have been in excess of 1.5 cGy.

B. Tritium is a low energy beta emitter. This low energy beta particle cannot penetrate the intact Pyrex tube. However, if the tube is broken, the tritium gas will dissipate, and outer surfaces of the device as well as surfaces in the near vicinity of the break may become contaminated. No maintenance action can be performed on devices that contain tritium if it is suspected that the

Pyrex tube containing the tritium gas has been broken or is leaking. Lack of illumination is an indication that the source may be damaged.

6. Depleted Uranium (DU) munitions. Because of its high density and structural properties, DU can be applied defensively to protect against penetration by projectiles made of less dense metals, such as tungstoncarbide subprojectiles. DU can be applied offensively as projectiles to defeat armored targets. US Abrams tanks, Bradley Fighting vehicles, the Marine Corps AV-8B Harrier aircraft, and the Air Force's A-10 aircraft fire DU munitions. DU ammunition is NOT used for training.

A. Armor. The newest M1A1 tanks, dubbed "Heavies," have depleted uranium packets "molded" into the turret armor. A "U" at the end of the turret serial number identifies tanks with this material. The M1A2 tanks also contain these DU packets in the turret armor package.

B. Munitions. The combination of high hardness, strength, and density makes DU alloys well suited for armor piercing projectiles. Most DU munitions are identifiable by their black color with white markings on the projectile end. However, corrosion may alter this color. All peacetime firings are prohibited except on ranges which are approved and licensed by the NRC and/or have host nation agreement.

Figure 3-A: M1A1 Infinity Collimator (contains 10 Ci of Tritium)



tritium is located here

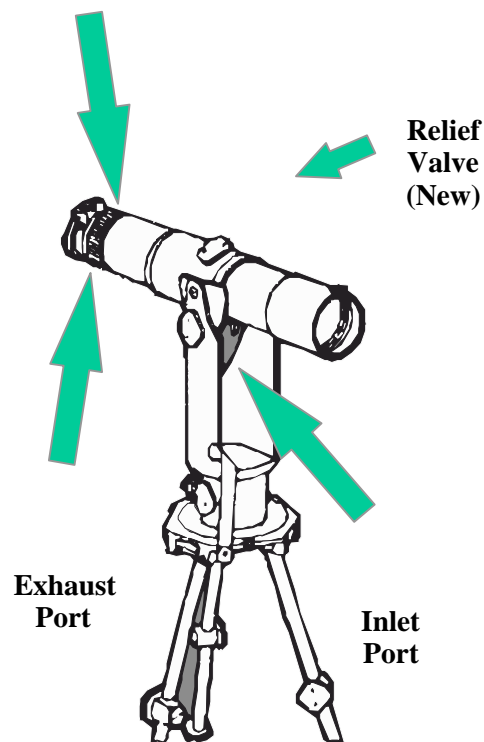
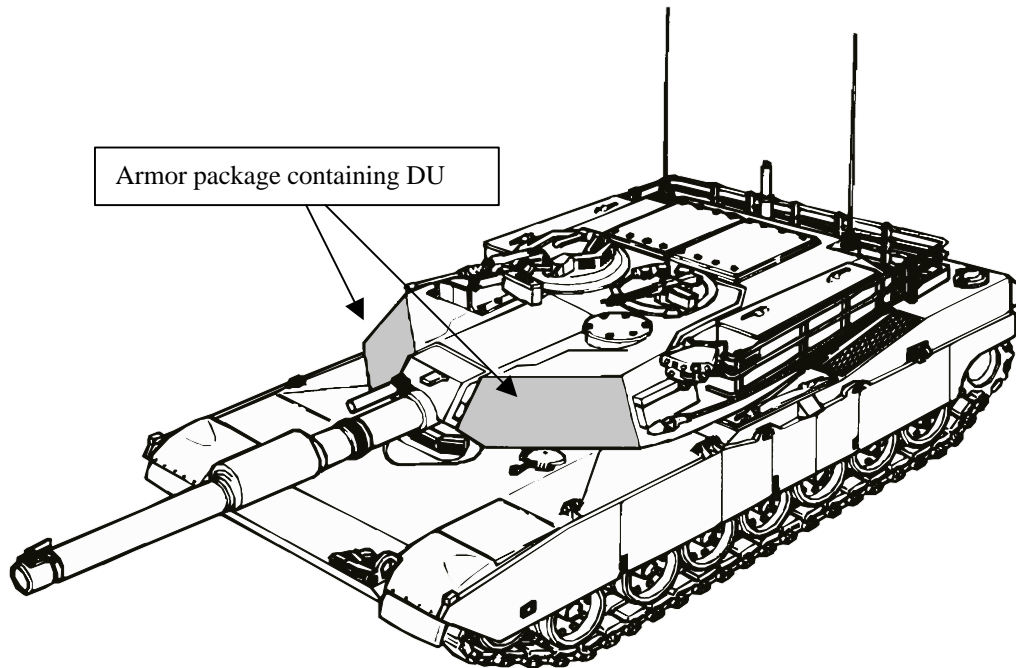
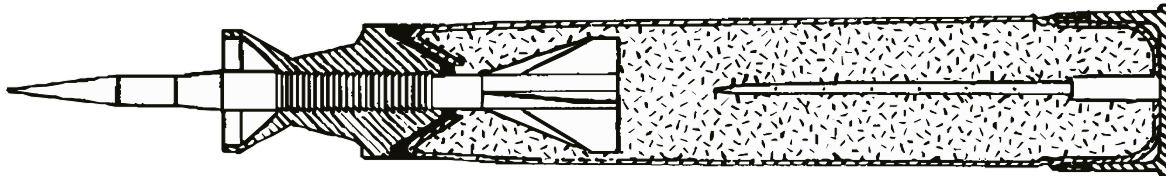

Table 3-E: Commodities that contain Tritium

Item		Activity (Curies)	
M1 Series Tank	MRS	Muzzle Reference Sensor	10.0
M119A1 Howitzer	M137A1	Panoramic Telescope	5.1
	M187	Telescope Mount & Quadrant	2.65
	M90A2	Straight Telescope	1.6
	M140	Alignment Device	3.0
M102 Howitzer	M113A1	Panoramic Telescope	4.0
	M134A1	Telescope Mount	0.15
	M114A1	Elbow Telescope	5.6
	M14A1	Fire Control Quadrant	2.15
	M140	Alignment Device	3.0
	M1A1	Infinity Collimator	10.0
	M1A2	Gunner's Quadrant	0.075
	M58	Aiming Post Light	5.0
	M59	Aiming Post Light	9.0
M198 Howitzer	M137	Panoramic Telescope	5.1
	M171	Telescope Mount	0.15
	M17	Fire Control Quadrant	1.875
	M18	Fire Control Quadrant	1.95
	M139	Alignment Device	3.0
	M1A1	Infinity Collimator	10.0
	M1A2	Gunner's Quadrant	0.075
	M138	Elbow Telescope	4.4
M110 & M109 Series Self-Propelled Howitzer	M140	Alignment Device	3.0
M224 Mortar	M58	Aiming Post Light	5.0
	M59	Aiming Post Light	9.0
	M64A1	Sight Unit w/ M9 Elbow Telescope	6.69
		Range Indicator	3.2
M121 Mortar and 252 Mortar	M58	Aiming Post Light	5.0
	M59	Aiming Post Light	9.0
	M64A1	Sight Unit w/ M9 Elbow Telescope	6.69
M120 Mortar	M58 & M59	Aiming Post Light	9.0
	M67A1	Sight Unit w/ M9 Elbow Telescope	5.79
M16A1 Rifle		Front Sight Post	0.009
M11 Pistol, 9mm		Front Sight Post	
		Rear Sight Assembly	

Reference: ACALA's *Radioactive Material Handling Safety* and CECOM-TR-11.

Figure 3-B: M1 Tank with DU Armor**Figure 3-C: 120mm M829 Sabot-Tracer****Table 3-F: DU Munitions**

Tank Ammunition		Bradley	Airforce	Marines
105 mm	120 mm	25 mm	30 mm	25 mm
M900	M829	M919	PGU-14/B	PGU-20
M774*	M829A1		PGU-14A/B	
M833*	M829A2		PGU-14B/B	
	M827*		PGU-14A/A	

*No longer fielded or in inventory

Reference: ACALA's *Radioactive Material Handling Safety* and CECOM-TR-11.

7. Thermal Optics. Thermal optics possesses a multi-layered infrared anti-reflective coating that contains Thorium-232 as a fluoride compound (thorium tetrafluoride). This hard coating is covered with a protective layer of a non-radioactive compound that prevents direct contact with the thorium surface. Care should be taken in the handling of these optical components to avoid inhalation and/or ingestion of any particles inadvertently chipped or scratched. Prompt first aid attention should be given to anyone receiving a cut caused by broken and/or chipped thorium fluoride coated lenses. Prompt cleansing of the wound to minimize entrance of thorium particles into the body is extremely important and the Safety Officer must be notified at once. Wearing rubber gloves to handle lenses provides protection from contaminated dust on chipped or broken

thermal optics. Maintenance personnel should also wash their hands with mild soap and water after handling thermal lenses or windows.

Figure 3-D: Thermal Optics on M1 Tank



8. M8A1 Chemical Alarm. A component of the M43A1 is a cell module that contains a radioactive source of 250 μCi of Americium-241. The M43A1 Chemical Agent Detector is a component of the M8A1 alarm. The source is located in the cell module of the detector. It consists of a foil disc made of 250 μCi of Americium-241 oxide in a gold matrix contained between a gold-palladium alloy face and a silver backing. The disc is affixed onto a metal screen that is secured by a retaining ring within the sensing housing. This source is considered a “special form” source. See the equipment chapter for more information.
9. CAM. The Chemical Agent Monitor (CAM) uses 10 millicuries (mCi) of Nickel-63 plated on a brass foil cylinder inside a Teflon housing that is installed in a larger aluminum alloy cylinder. See the equipment chapter for more information.
10. Density and Moisture Tester (MC-1). A 50 mCi mixture of Americium-241 and Beryllium is located within the base of the MC-1 (about 200 times more than is used in the M43A1 Chemical Agent Detector). Neutron emission occurs when an alpha particle emitter such as Americium-241 is mixed with Beryllium (Be) powder in a tightly compressed pellet. The MC-1 also has a 10 mCi Cesium-137 source located in a probe tip used to determine the density of the soil at a construction site. This source is classified as a “special form” source and is double-encapsulated in stainless steel. TACOM is the NRC license holder for the MC-1 and is responsible for item management.
11. Check Sources. The following isotopes have been used by the military as check sources: Cobalt-60, Krypton-85, Strontium-90, Barium-133, Cesium-137, Lead-210, Radium-226, Thorium-232, Uranium-238, and Plutonium-239. As such, they are normally found as sealed sources associated with radiation detection instrumentation or in a calibration lab, and would take some serious effort to release to the environment. Sealed sources represent an external exposure hazard only (unless they are physically destroyed). One other item that should be considered with respect to sealed source beta emitters is that they are often associated with lower energy. The other sources are gamma emitters, with the exception of the Am-Be source that produces neutrons. The gamma emitters will expose the whole body externally, as will the neutron source. The sealed sources will be detected in most cases using the AN/PDR-77 with the beta/gamma probe.
12. Dials and Gauges. Radium-226 was used on the faces and pointers of dials and gauges of instrument panels in tactical and combat vehicles. These items are no longer in DOD storage depots and have not been procured since 1969. The easiest way to tell for sure if a gauge or dial might contain radium or some other radioactive material is to check it with a radiac meter (but remember that fielded radiac instruments cannot detect tritium). There is also

an additional hazard from the Radium-226 progeny, such that they will cause some external exposure, and Radon-222 gas can escape from the instrument. These problems can cause area or personnel contamination as well as personnel inhalation or ingestion exposures. Foreign vehicles may contain a variety of radioactive sources to include Radium-226.

3.9. General Operational Guidance

1. Reference: FM 8-9, FM 8-10-7, AMEDD Center and School's *Effects of Nuclear Weapons and Directed Energy on Military Operations*, and DOD 5100.52-M (Nuclear Accident Response Procedures Manual – NARP).
2. Time, Distance, and Shielding.
 - A. Time (Minimizing Exposure Time). The less time spent within a radiation field, the lower the dose. By having mock-ups and trial runs of jobs where the possibility of significant exposures exists, workers can minimize their doses.
 - B. Distance (Maximizing Distance from the Radiation Source). The inverse square law states that the dose rate from a point source decreases with the square of the distance from the source. For example, if the dose rate at 1 meter from a source is 0.100 cGy/h, at 2 meters the dose rate will be about one quarter or 0.025 cGy/h. The larger the distance from a radiation source the lower the dose.
 - C. Shielding (Shielding the Radiation Source). Properly shielding a radioactive source requires knowledge of the type of radiation being emitted. For example, one would use a different type of shield from a beta and alpha source than for a gamma source because of their different ranges in air and material (tissue). In general, exposure can be reduced/minimized with the appropriate shielding design.
 - D. Alpha Shielding. Alpha particles are heavy charged particles with very low range in air. They can be stopped with a sheet of paper or at the skin. The problem arises when external contamination with alpha particles or airborne exposure leads to internal contamination. Any light clothing or gloves used to prevent contamination of underlying clothing or the body will provide protection automatically from this type of external radiation.
 - E. Beta Shielding. Although beta particles can travel significant distances in air, solid materials easily stop them. A sheet of aluminum can stop most beta emissions. Beta emitting sources should be handled with care. Eye-protection should be used when handling Beta emitters.
 - F. Gamma shielding. Gamma ray photons are typically more penetrating than alpha and beta particles, and can present an external radiation hazard. Shielding of gamma ray photons is a function of absorber thickness and density and is based on the probability that the gamma ray photons will interact with the medium with which they pass through. As the thickness of an absorber is increased, the intensity of the gamma radiation will decrease. Higher density media like lead, tungsten, steel, and concrete are good for shielding gamma ray photons.
3. Internal Hazards. In many cases, the primary health hazard from radiation is through internal contamination (usually inhalation). The rate at which contamination may be inhaled is highest during the initial period following the accident when a substantial quantity of contamination

maybe airborne. Limiting the access to the area until contaminants settle may reduce the contamination of personnel. If this is not possible, use respiratory protection.

4. **Radiation Surveys.** Environmental radiation surveys are performed to record background levels of radiation and radionuclide concentrations in the environment. Surveys should be part of the planning strategy when dealing with possible radiation exposure. Routine surveys would generate adequate control of the present environmental exposures and possible contamination incidents.
5. **Personnel Dosimetry.** Personnel dosimeters are needed to estimate the actual dose received by an individual. Dose rates change with changing conditions; the time spent in a given area is often not known, and sometimes surveys are misleading. Personnel dosimeters are the dose values of record whereas survey reports are used in planning jobs.
6. **Skin Contamination.** To reduce skin contamination and the chances of spreading contamination, it is essential to use gloves, remote handling tools (when appropriate), and other precautions. However, these precautions may increase the time spent in the radiation field and increase the overall dose to the exposed individual.
7. **Bioassay.** Bioassay should be performed in conjunction with other survey data. Such situations include being in or near a vehicle as it is hit by a DU round or after it has been hit, climbing on such vehicles before they are completely decontaminated, or being in a room when a firing control device containing tritium breaks. Because of the advanced armor, munitions that penetrate the armor of a M1 should be assumed to be DU. Also assume all tanks and vehicles killed by US forces are contaminated with DU. Many foreign vehicles use radium for dials and gauges. Foreign vehicles may contain other radioactive commodities. Bioassay samples from personnel in contact with damaged foreign vehicles should be analyzed for these commodities. USACHPPM's TG 211, Radiobioassay collection, Labeling, and Shipping Requirements, contains the procedures for submitting a bioassay sample.
8. **Contaminated Food and Water.**
 - A. Operational rations are safe when surface decontamination is performed before breaking the package. The package should be thoroughly washed with water to remove the contamination.
 - B. If a nuclear weapon is used, rations stored closed to ground zero may become radioactive from induced radiation, but it is more likely that they would be destroyed by the thermal pulse.
 - C. Food harvested from an area that is contaminated by radiation may present a hazard. Meats and milk are the most vulnerable products because of the possibility for concentrations of radioactive isotopes (strontium, cesium, and iodine). All unpackaged and uncovered food, such as vegetables, fruits, and carcass meats, should be considered contaminated if obtained from a known area of contamination. If food supplies are critically low, the contaminated supplies may have to be consumed. In this event, it may be advisable to dilute the contaminated food by mixing with uncontaminated food. For more information, see page 1-34 of *Effects of Nuclear Weapons and Directed Energy on Military Operations* published by the AMEDD Center and School.

3.10. Radioisotopes from Nuclear Weapons

This section contains tables listing the principal radionuclides induced in soil by a fission weapon and the approximate yields of the principal nuclides from such weapons.

Table 3-G: Principal Radionuclides Induced in Soil

Isotope	Half Life	Ci per megaton
Sodium-24	15 hours	2.8×10^{11}
Phosphorus-32	14 days	1.92×10^8
Potassium-42	12 hours	3×10^{10}
Calcium-45	152 days	4.7×10^7
Molybdenum-56	2.6 hours	3.4×10^{11}
Iron-55	2.9 years	1.7×10^7
Iron-59	46 days	2.2×10^6

One Ci = 37 GBq.

Reference: Eisenbud (1997)

Table 3-H: Approximate Yields of the Principal Nuclides per Megaton of Fission

Nuclide	Half-Life	Mci
Strontium-89	53 days	20.0
Strontium-90	28 years	0.1
Zirconium-95	65 days	25.0
Ruthenium-103	40 days	18.5
Ruthenium-106	1 year	0.29
Iodine-131	8 days	125.0
Cesium-137	30 years	0.16
Cerium-131	1 year	39.0
Cerium-144	33 days	3.7

One MCi = 37 PBq

Reference: Eisenbud (1997)

3.11. Nuclear Weapon Accident

Information concerning nuclear weapon accidents is currently under revision at DTRA (DOD 3150.8M) and, for Army specific subjects, USANCA (AR 50-5 & DA Pam 50-5). Please refer to these publications for information.

3.12. Hazard Predictions of Radiological Releases

1. Reference: Joint Pub 3-11 (Draft)
2. Joint Pub 3-11 (Draft) covers the procedures to warn and report NBC releases including Releases Other Than Attack (ROTA). This information is not reproduced here since the publication is still under review. ROTAs include NBC releases due to damaged or destroyed storage bunkers, transport vehicles, storage or production facilities, ammunition supply sites, power plants, etc. It also includes the use of radiation dispersal devices.

Table 3-I: Description of Radiological ROTA Cases

ROTA Cases	Description of ROTA Cases	Remarks
Nuclear Reactor	Nuclear material released into atmosphere from damaged nuclear reactors, nuclear fuel storage, and production facilities.	Can result in very high levels of radiation covering distances of hundreds of kilometers.
Nuclear storage material	Damage to a nuclear or radiological material storage facility.	Low-level radiation covering a fairly short distance. Intentional release of large amounts of radiological material, can result in hazard areas extending far downwind.

Reference: Table E-2-5 of Joint Pub 3-11 (Draft).

Table 3-J: Radiological Hazard Prediction Methods

Hazard Cases	Prediction Procedure	Remarks
Nuclear Reactor	None currently. (Suggest contacting USACHPPM and DTRA for assistance.)	There are no prediction procedures at this time.
Release from nuclear material storage facility	<p>SMALL RELEASE: Draw 1 km radius circle around release point..</p>	<p>SMALL RELEASE: Circle becomes exclusion area. Release area will be very localized, and hazard area is not expected to be large. Cloud may be toxic at low levels for an extended time.</p>
	<p>LARGE RELEASE: JP 3-11 suggest using the biological hazard prediction type S, Case 2 for large releases. However due to security reasons, the draft did not furnish this information. Suggest contacting USACHPPM and DTRA for assistance.)</p>	<p>LARGE RELEASE: Use this procedure if a high level of radiation as a passing cloud. Release was probably intentional and large quantities of radioactive material may continue at toxic levels for a long downwind distance.</p>

Reference: Table E-2-6 of Joint Pub 3-11 (Draft).

3.13. Response to Commodity Accidents

1. Reference: ACALA’s *Radioactive Material Handling Safety*.
2. General. The following are general guidelines for accidents involving radioactive commodities and for the use of radiological dispersal weapons. Please consult local policy for specific guidance.
 - A. Notify all personnel not directly involved to vacate the area. If at all possible, personnel should vacate to an area that is up wind of the accident.
 - B. Hold your breath while switch off all fans and central air circulation equipment.
 - C. Vacate the area.
 - D. Close all entrances to the accident area and post guards to prevent unauthorized access.

- E. Notify the local RSO.
 - F. Identify to the local RSO any personnel who may have been exposed to radioactive contamination.
 - G. In coordination with the RSO:
 - (1) Decontaminate personnel leaving the area.
 - (2) Remove the hazardous material.
 - (3) Decontaminate the area.
 - (4) Perform an area survey to determine effectiveness of decontamination procedures.
 - (5) Monitor all personnel suspected of being contaminated.
 - (6) Make sure that proper reporting procedures are implemented. Reporting requirements depend on the severity of the accident and the degree of contamination. For additional guidance, contact ACALA.
3. Tritium Source. If a Tritium source is broken during handling, inform all personnel to vacate the area and move up wind from the device. When a tritium source breaks or is no longer illuminated, the local RSO must be notified, and the following actions must be taken under the direction of the RSO:
- A. Anyone who may have touched or handled the broken Pyrex tube should wash as soon as possible with non-abrasive soap and warm water.
 - B. Personnel handling the device should wear rubber or latex gloves.
 - C. The device must be immediately double wrapped in plastic. The outside container must be labeled "BROKEN TRITIUM DEVICE -- DO NOT OPEN". Store the broken device outside in a secured container. Contact the supply item manager of the damaged equipment for disposition instructions. Dispose of used gloves as radioactive waste per direction of the local RSO, and then wash hands well.
 - D. Personnel who may have handled the broken tritium device should report to the health clinic for a tritium bioassay. The optimum bioassay sample time is approximately four hours after the exposure. A minimum of four hours is necessary for tritium to reach equilibrium in the human body. Only after this minimum time should a urine sample be taken. For information on bioassay procedures and to receive bioassay kits, contact the USACHPPM.
 - E. Broken tritium devices indoors may result in tritium contamination of the workbench, table, or the surrounding area. The area must be cordoned off and restricted until a wipe test in the area indicates that no contamination remains on the surface.
 - F. Due to tritium's low energy level, portable detection equipment may not be available that will detect its presence. The only method of detecting tritium is by performing wipe tests and evaluating the wipe test on a liquid scintillation counter.
 - G. Dispose of used gloves as radioactive waste per instructions from the local RSO.
 - H. See the section on Tritium for medical response to exposure.
4. DU Incidents.

A. TB 9-1300-278 details the safe response to accidents involving army tank munitions that contain depleted uranium. CTT Task 031-503-1017, Respond to Depleted Uranium/Low Level Radioactive Materials (DULLRAM) Hazards (draft) details the response of individual soldiers to these hazards.

B. Required notification: IOC.

C. In general, individuals in the vicinity of the incident should wear some type of respiratory protection, cover exposed skin, decontaminate as soon as possible, and submit bioassay samples for analysis.

D. Safe distances for storage sites. Munitions in storage pose little threat to soldiers. During an incident, the area downwind from the incident should be evacuated. The recommended evacuation area downwind depends on the number of rounds involved in the accident. For 200 rounds, 122 m is recommended. For 5000 rounds, 1800 m is recommended.

E. CTT Task 031-503-1017 recommends a safe distance of 50 m from vehicles hit by DU. The use of depleted uranium munitions will probably be wide spread in future conflicts. Treat all personnel wounded while in a vehicle as if they were wounded by DU until proven otherwise.

3.14. Medical Planning Specific to Radiological Contaminated Areas

1. References: FM 8-9 (Part I) and FM 8-10-7.
2. See Annex C of FM 8-9, Part 1 for “General Guidelines for Medical Support in Nuclear Accidents.”
3. Protective Clothing. Protective clothing generally consists of coveralls made of closely woven material. Two pair of such coveralls are usually worn, along with cotton or rubber gloves, rubber boots, and protective caps or hoods. All openings, such as where the gloves overlap the sleeves, are sealed, usually with adhesive masking tape. It has been found that untreated cotton fabric is a reasonably effective barrier to dust and that it is easily decontaminated by normal laundering procedures. Furthermore, water vapor can penetrate the fabric, thus enabling normal body cooling mechanisms to function. However, this allows tritium to penetrate the material since it can form water molecules. Finally, clothing worn for protection against particulate contamination will become contaminated itself and must be removed as an individual leaves a contaminated area. The way in which the clothing is removed must be carefully supervised so personnel do not contaminate themselves during the procedure.
4. Inhalation Protection. Clothing must be worn with an efficient full-face mask in order to achieve reasonable protection against particulate aerosols with a high percentage of very small particles. Standard military protective masks are excellent protection for most hazards. Personnel inside ambulances should wear them until the patients are brought to the medical facility. Standard surgical masks should afford safety from radioactive particulate for hospital personnel except for possible cases dealing with enriched uranium and plutonium.
5. Decontamination of Equipment. In most cases of contamination of equipment and buildings, a mixture of normal household cleaning methods will remove the material. Prior to decontamination conduct a radiation survey of the equipment. Vacuum cleaners that can handle wet material and have high efficiency filters are particularly useful. Some surfaces may require

repeating scrubbing and vacuuming before they are free of contamination. Personnel need to be trained in the procedures.

6. **Guidelines for Patient Decontamination.** The practical decontamination of radiological contaminated patients is easily accomplished without interfering with the required medical care. Ninety to ninety-five percent of the decontamination can be accomplished by simply removing the outer clothing and shoes. Once removed, contaminated clothing can be placed in bags, tagged, and removed to a remote section of the medical facility to avoid creating a hazard due to concentration of such contamination. The decontamination or disposal of the contaminated clothing should be addressed by the unit's standard operating procedures. The second phase of decontamination consists of washing or wiping the patient's face and hands. This should leave the patient essentially decontaminated. This simple task can be accomplished prior to admission, later on the ward, or elsewhere in the medical facility as the situation dictates. The third phase of decontamination consists of washing the hair, or clipping the hair and washing the scalp. The third phase need only be accomplished if the patient arrives without headgear and/or monitoring indicates that the hair is contaminated.
 - A. Upon entering a medical treatment facility, patients from a contaminated area should be decontaminated and monitored for radiation. Monitoring by trained health physics personnel may be required to determine when it is proper to discontinue isolation techniques. Such personnel are usually located at the medical group level (see section 3.1).
 - B. A more extensive decontamination procedure is to scrub the areas of persistent contamination with a mild detergent or a diluted strong detergent. Caution should be taken to not disrupt the integrity of the skin while scrubbing because disruption can lead to the incorporation of the radioisotopes into deeper layers of the skin. Contaminated wounds should be treated first since they will rapidly incorporate the contaminant. Washing, gentle scrubbing, or even debridement may be necessary to reduce the level of contaminants.
 - C. Normal surgical management of wounds will be more than adequate for removal of radioactive contamination and special procedures are not required. Rinse water or sponges should not be disposed of until expert consultations have been obtained. Material objects from the wounds must be saved and if separable from the rest of the waste, put in specially marked bags. These fragments will be studied by technical experts and require special disposal. Such personnel are usually located at the medical group level (see section 3.1).
7. **Biological Collection.** Refer to USACHPPM's TG No. 211 for radiobioassay collection, labeling, and shipping requirements. If the patient urinates, the urine should be saved for analysis for radiological contamination. Normal urinalyses can be done on portions of the sample with safety, but the laboratory should be notified that there is a potential contamination with radioactive material. It is essential that the laboratory keep a record of the volumes of urine so those appropriate laboratories can make later calculations of estimated body burdens of radioactive materials. Fecal samples should also be taken and retained in addition to nose blows and swabs.
8. **Nuclear Accident.** The potential public health hazard is fairly minimal. As a result there is very little chance of these elements being ingested either by animals or humans. Even if ingested, their insolubility all but completely precludes any absorption from the gastrointestinal tract. The major hazard is inhalation of the material if it is suspended in the atmosphere. However, the amounts required to cause any significant risk of pulmonary disease are very much greater than will

normally be present, particularly once material from the accident is dispersed widely on the ground. Therefore, the inhalation hazard to people living near an accident area is minimal except during times when extensive cleanup operations are going on and materials are being resuspended in the atmosphere. Monitoring of the degree of atmospheric resuspension of hazardous materials with specially designed air samplers must be carried out during such operations. See section 3.1 for units that can provide assistance.

9. Management of Contamination. Resuspension of materials into the atmosphere would be the most serious hazard and extensive monitoring would be required. Wetting down the area with airborne water tankers might be required. If the levels of activity allow cleanup operations to proceed, soil may have to be removed and buried in sealed containers. Individual countries establish the levels to which decontamination is carried out for peacetime use.

3.15. NATO Policy on Low Level Radiological Hazards

General Information: ACE DIRECTIVE 80-63: ACE Policy for Defensive Measures against Low Level Radiological hazards during Military Operations is NATO guidance issued 2 August 1996. It is not presently guidance for all US forces, however the latest draft of Joint Pub 3-11 does contain similar guidance. The directive is presented below in its original form with slight editing to reduce its length. The National Academy of Science's Institute of Medicine has reviewed ACE DIRECTIVE 80-63. The review can be found at: www.nap.edu/readingroom/books/radiation/.

This directive supersedes Allied Command Europe (ACE) Directive 80-63. Dated 10 January 1996. ACE Directive 00-1, "Index to ACE Directive and Manuals" is to be amended to indicate the current date of this directive.

REFERENCES for ACE Directive 80-63: ACE Directives 75-3, ACE Directive 80-14, STANAG 2002, STANAG 2083, STANAG 2103, STANAG 2112, STANAG 2150, and STANAG 2352.

1. APPLICABILITY. This directive is applicable to all ACE International Headquarters and formations under operational control of SACEUR.
2. SUPPLEMENTATION. Supplementation is not authorized without SHAPE approval.
3. INTERIM CHANGES. Interim changes are authorized when approved by the Director of Staff Operations (DOSO).
4. PURPOSE. To designate defensive measures against Low Level Radiological Hazards that may be encountered during military operations.
5. BACKGROUND.

A. During military operations, hazards not normally considered significant during wartime may become important and impact operations. These hazards may be more significant during operations other than war such as peace support and peacekeeping. One of the hazards that may confront ACE Forces are radiological hazards that do not occur from a nuclear detonation. These hazards may occur from inadequate nuclear waste disposal, deterioration of nuclear power facilities and damage to institutions that routinely use radioactive material/sources and terrorism.

- B. ACE forces may expect to encounter two levels of radiological hazard.
- (1) Operationally Significant Level Radiation exposure that produces effects of immediate military relevance. The doses received from these exposures are comparable to those from the detonation of a nuclear weapon and are in the range of 70 cGy and above. Common effects along the radiological dose spectrum include reduced military effectiveness (beginning at 70 cGy) due to nausea and can include death at doses above 300 cGy.
 - (2) Low Level Radiation (LLR) exposure produces a risk to soldiers of long term health consequences. The doses received from these exposures are higher than those routinely received by health physics workers and the general public and are in the range from background radiation to 70 cGy. The primary consequence of exposure may be induction of cancer in the longer-term post exposure. Additional health risks that may occur are teratogenesis and mutagenesis and their associated psychological and social consequences. The hazard from LLR may result from Alpha, Beta, or Gamma radiation.
- C. This directive will outline policy and procedures for ACE force protection against Low Level Radiation. Wherever applicable, the policy will reference current NATO Standardization Agreements, Allied Tactical Publications, and ACE Directives and will follow NATO concepts and doctrine.
6. POLICY. The following general policies apply with regards to exposure of ACE forces to known radiological hazards.
- A. Deliberate exposure of ACE forces to a radiological hazard shall not be permitted unless it is required by military necessity.
 - B. All exposures of soldiers to radiological hazards during operations must be kept as low as reasonably achievable consistent with military necessity.
 - C. Detailed planning and coordination for the conduct of operations in the area of a radiological hazard is essential.
 - D. All levels of ACE command should keep a totally open flow of information regarding the existence and status of radiological hazard areas within the military structure. However, Commanders should be aware that potential belligerents could use radiological hazards to increase tensions. Therefore, Commanders shall apply an appropriate level of security with regards to release of this information to civil authorities and the general public.
 - E. Detailed and accurate record keeping is a prerequisite if operations in a radiological hazard area are approved. Record keeping of individual soldier exposures as a dose control measure shall be conducted.
 - F. Commanders shall ensure that subordinate formations are aware of this policy and have the appropriate equipment and personnel to implement it. When available, individual dosimetry for all forces shall be used.
 - G. Formations that do not possess the appropriate equipment, personnel, and training as described in this document and other relevant NATO standards shall not be used in radiation hazard areas.
 - H. Commanders shall consult with all appropriate staff specialists prior to any operations in radiological hazard areas. At a minimum, this consultation shall include the NBC Defense Officer,

Legal Officer, Medical Officer, and Public Affairs Officer. When possible, the Medical Officer shall have an appropriate knowledge of radiological hazards.

7. PROCEDURES. The following procedures apply to ACE forces performing operations in an area where there is a risk of exposure to low level radiological contamination. For purposes of this directive, the operational commander is defined as an Army Division level or equivalent commander.

A. Intelligence - Prior to entry into the area, intelligence assets shall provide the ACE operational and local commanders with suspected areas of radiological hazard. The intelligence community shall provide an assessment of the risk (High or Low) of radiological hazard in each suspected area. When possible, details concerning the extent, source and type of hazard shall be provided.

B. Required Capability - All units operating in the area of radiological hazards shall have the capability of individual and group total dose dosimetry, radiological dose rate measurement and the appropriate means to record dosimetry once radiological hazard is encountered. Radiological dose rate and total dose measuring instruments shall have the ability to measure at least .0001 cGy/hour. It is essential for dose rate instruments to measure alpha and beta emitting particles as well as gamma radiation.

C. Actions upon the identification of a High Risk of a Suspected Radiological Hazard

(1) Upon receipt of an intelligence estimate of a high-risk radiological hazard, the operational commander shall order an exclusion area around the location. The Commander shall establish a minimum exclusion zone of a 1KM radius around the suspected radiological hazard. The commander shall direct an evacuation of all ACE forces in the zone until appropriate follow on actions, as described in this directive, are accomplished. If necessary, essential aviation assets are permitted to transit the exclusion zone at a height of at least of 175 meters.

(2) If the excluded area is not planned for use by military forces then subsequent actions concerning the hazard become a civilian responsibility. However, if military necessity dictates that ACE forces will be required to operate near or at the suspect location, the operational commander shall direct the conduct of an NBC Survey to determine the extent of the hazard.

(a) Prior to the survey mission, the theater commander shall issue Operational Exposure Guidance designating a maximum Radiation Exposure State in accordance with the enclosed Low Level Radiation Operational Exposure Guidance. During Operations Other Than War, the theater commander is limited to RES Categories 1A through 1D. RES Category 1E is limited to wartime operations only and intentional exposures in this category require additional justification.

(b) The following elements conduct the NBC Survey:

- i. Supporting NBC units equipped with NBC Reconnaissance assets.
- ii. NBC Survey Teams who are organized and adhere to standards of proficiency in accordance with STANG 2150. "Standards of Proficiency for NBC Defense" and ACE Directive 75-3, "NBC Defense Organization, Equipment and Training" for ACE Headquarters and Formations Under OPCON or SACEUR.

(c) Prior to the survey mission, the team will determine the average radiological background level in a local area known to be free of contamination. The turn back dose

rate for a Low Level Radiation survey is .0003 cGy/hour. Upon reaching that dose rate, the survey team will back out of the area until a dose rate reading of .0002 cGy/hour is reached. This point is considered to be the outside limit of radiological hazard.

(d) The survey of the radiological hazard area is to be accomplished in accordance with STANG 2112, "NBC Reconnaissance." However, the survey team will only survey to determine the outside limits of the radiological hazard. Under no circumstances are they to cross the boundary of contamination to make a complete survey. This will preclude unnecessary exposure to contamination.

(e) The survey team shall subsequently mark the hazard areas in accordance with STANAG 2002, "Warning Signs for the Marking of Contaminated or Dangerous Land Areas. Complete Equipment, Supplies and Stores." However, due to the existence of a Low Level Radiation hazard, survey units are required to record all readings above .0002 cGy/hour and mark the associated areas.

(3) Units operating near the boundaries of the exclusion area prior to completion of an NBC survey shall initiate continuous monitoring using unit level dose rate monitoring equipment. Units shall immediately report radiological detection to higher level headquarters. This is done using the standard NBC-4 format. However, the report is identified as an NBC-4 ROTA report. Line Hotel will indicate NR2 (Nuclear Release Type 2) as the type of agent in all reports. Line Gentext will indicate any other information about the source as applicable. Line X Ray will indicate the Grid Coordinates for the outside limit of the radiological hazard. Line Romeo is not used. All other lines of the NBC-4 report remain the same as reporting a traditional NBC-4 Nuclear report. When entering data in Line X Ray, the survey team shall enter decimals of Centigray/Hr readings in the readings that are below 1 Centigray/Hr.

(4) Once all survey results are completed, the operational units NBC Defense Cell shall compile them and an overlay that outlines the extent of the radiological hazard shall be produced. These predictions shall be sent via NBC-5 message to all units in the area of operations. The message shall be identified as an NBC-5 ROTA report. The report is formatted as follows:

Table 3-K: Line items for the ACE DIRECTIVE 80-63

Line	Item
Alpha	Strike Serial Number
Delta	Date Time Group of Initial Detection
Hotel	Type of ROTA Release (NR2 for LLR)
Tango	Date Time Group of Latest Survey
X-Ray	Grid Coordinates indicating the outside limit of the Radiological hazard
Gentext	Additional information (More detailed survey results)

(5) The NBC Defense Officer of each operational headquarters in theater shall maintain a current list of all confirmed, suspected and potential radiological hazards within his area of operations. The NBC Defense Officer at the highest operational headquarters shall monitor the status of these areas and make periodic updates for issue to ACE units.

D. Actions upon Identification of a Low Risk Suspected Radiological Hazard - The actions of the operational commander in this instance are quite similar but vary slightly with regard to initial steps. As the suspected area only has a low probability of hazard, the operational commander should not initiate an exclusion area. If possible, the operational commander shall initiate an NBC Survey prior to units entering the area. If contamination is detected, the procedures in section 3.15.7.C apply.

E. Once the determination is made that a suspected radiological hazard area is in fact clear, it may be removed from the current list of radiological hazard areas. However, if it is confirmed that there is radioactive material present but is not currently hazardous, the site shall remain on the current list of radiological hazard areas as a potential site. Units operating in the vicinity of potential radiological hazard areas shall initiate periodic monitoring.

F. Operations within Confirmed Radiological Hazard areas - If military necessity requires units to operate in a confirmed radiological hazard area, the Operational Commander must initiate dose control measures as part of the operation and employ the procedures in the paragraph. It is assumed that all actions outlined in section 3.15.7.C, especially with regards to exclusion zones and evacuations, have control.

(1) Prior to deliberate operations in an identified radiological hazard area, the Operational Commander will direct a detailed NBC survey of the area to determine the exact hazard and the associated radiological dose rates. The survey may require radiological specialist teams not normally available in national military operational formations. If required, the Operational Commander shall request the appropriate assistance from national military authorities. Once the survey is complete, the results will be transmitted to appropriate operational commands via the NBC-5 report.

(2) Prior to the survey and subsequent operations in the area, the Theater Commander must determine what risk he is willing to subject his soldiers to as part of the operation. The Theater Commander will use the enclosed Low Level Radiation Operational Exposure Guidance (Annex A). The Theater Commander shall issue Operational Exposure Guidance designating a maximum Radiological Exposure State (RES) for all individuals that must perform the mission. This RES shall be developed in consultation with those staff specialists listed in section 3.15.6. During Operations Other Than War, the theater commander is limited

to RES Categories 1A through 1D. RES Category 1E is limited to wartime operations only and intentional exposures in the category require additional justification.

(3) All Commanders must ensure that once a decision to allow exposure to any level of radiation is made, radiation dose management systems are initiated in accordance with national regulations. The Commander shall ensure that the dose a soldier receives is accurately recorded upon each radiological exposure and that the total dose is annotated in his individual national medical record in accordance with national regulations.

(4) The theater commander shall ensure that the appropriate medical and NBC Cells are tasked to receive, monitor, and maintain all radiological data in accordance with national regulations.

(5) If a unit encounters higher than expected radiation and is in danger of exceeding the designated RES level, it must report the situation, withdraw from the area, if militarily acceptable, and receive further guidance from the Commander.

G. Other Actions Relevant To Exposure to Radiological Hazards

(1) Individual Protection - While in radiological hazard areas, individuals shall wear clothing that will not allow radioactive dust to cause injury to exposed skin. All exposed skin shall be covered to prevent deposition of radioactive dust. Individuals in the radiological hazard area shall wear respiratory protection to ensure that inhalation of radioactive dust does not occur.

(2) Monitoring of Consumables - Commanders shall direct the monitoring of local produce, water, and foodstuffs that may have been exposed to radiological hazards, prior to their issue to ACE forces.

(3) Hazard Area Restoration - Removal of the radiological hazard is not a military mission unless the Commander has a clear need for the facility out of military necessity. Commanders shall involve Civil-Military affairs officers once the extent of the radiological hazard is realized to ensure coordination is conducted with the civilian authorities for site restoration.

(4) Decontamination - Once operations in a radiological hazard area are complete, all equipment shall be monitored for radiological contamination. If contaminated, equipment shall be decontaminated to the lowest level achievable with military means prior to further use.

Table 3-L: Guidance Low Level Radiation Operational Exposure

Total Cumulative Dose (cGy)^{1,2,3}	RES Category	State^{4,5}	Actions
<0.05	0	NO RISK	- None
0.05 To 0.5	1A	NORMAL RISK	- Record individual dose readings - Initiate periodic monitoring
0.5 To 5	1B	MINIMAL RISK	- Record individual dose readings - Continue monitoring - Initiate red survey - Establish dose control measures as part of operations - Prioritize tasks
5 To 10	1C	LIMITED RISK	- Record individual dose readings - Continue monitoring and update survey - Continue dose control measures - Execute priority tasks only (See note 6)
10 To 25 (See note 7)	1D	INCREASED RISK	- Record individual dose readings - Continue monitoring and update survey - Continue dose control measures - Continue to execute priority tasks only - Execute critical tasks only (See note 6)
25 To 70 (See note 8)	1E	SIGNIFICANT RISK	- Record individual dose readings - Continue monitoring and updating survey - Continue dose control measures - Execute critical tasks only

Reference: ANNEX A TO AD 80-63, DATED 02 AUG 1996

NOTES:

1. Dose is uniform to the entire body due to whole body radiation. This table does not consider the intake of radioactive material. This is assumed due to employment of effective respiratory protection and other measures as necessary.
2. All doses should be kept as low as reasonably achievable. This will reduce individual soldier risk as well as retain maximum operational flexibility for future employment of exposed soldiers.
3. The use of the measurement Millisieverts (mSv) is preferred in all cases. However, due to the fact that normally the military has only the capability to measure Centigray (cGy), ACE forces will use cGy as long as the ability to obtain measurements in mSv is not possible. For whole body gamma irradiation: 1 cGy = 10 mSv.
4. Risk is of long term health consequences, primarily induction of fatal cancer starting two years post exposure. Total lifetime risk is assumed to be four to seven percent per 100 cGy (= 1000 mSv). This is in addition to the 20-25% incidence of fatal cancer among the general population. Additional health risks that may occur are teratogenesis and mutagenesis and their associated psychological and social consequences.

5. It must be noted that higher radiation dose rates produce proportionally more additional health risks than the same total dose given over a longer period.
6. Examples of priority tasks are those missions to avert danger to persons or to prevent damage from spreading. Examples of critical tasks are those missions to save human life.
7. During peacetime, this dose shall not be exceeded except to save human lives.
8. RES category 1E covers a wide range of dose and its lower level (25 cGy = 250 mSv) is the peacetime maximum operational dose in many NATO nations. This category is normally only applicable in wartime. Intentional exposure to doses in this category (25-70 cGy = 250-700 mSv) require additional justification.

3.16. Contamination Limits

1. Reference: The NATO limits were proposed by Dr. Ludwig Schanzler of WIS-ABC-Schutz, Munster on 5 March, 1997 for WG.2 on Low Level Radiation in Military Operations. Other references include Reg Guide 8.21 and Reg Guide 8.23.
2. The table below provides contamination limits for operations in a radiological contaminated environment. Limits are given for 2 classes of radionuclides:
 - A. High-tox Alpha. Alpha emitters exhibiting high radiotoxicity. NATO Working Group 2 has recently defined forms of uranium (enriched, natural, and depleted uranium) as "low-tox." All other alpha emitters were defined as "high tox."
 - B. Beta and Low-tox Alpha. Normal beta emitters together with Low-tox alpha emitters from this group. Low energy beta emitters like C-14 are not considered as relevant for military contamination aspects.
3. If an alpha contamination is present, but a distinction between "alpha high-toxicity" and "alpha low-toxicity" cannot be made, guidance should be to use the "alpha high toxicity" class values.
4. When two or three decontaminations have been performed, the remaining activity is assumed to be fixed and is no longer considered except for its contribution to external radiation.
5. Actions to be taken during and after missions in contaminated areas.
 - A. Recommended actions will include periodic monitoring of the contamination level, decontamination of equipment and protective clothing, changing of protective clothing and proper behavior to avoid incorporation of radioactivity and an unnecessary spread.
 - B. When a skin contamination is detected, decontamination should be started as soon as possible to avoid intake by ingestion and irradiation of the skin. Decontamination can be stopped when the activity has become smaller than 10 Bq/cm² or when the activity reduction in a single decontamination is less than 10%. Only 1 skin contamination event is allowed in the commander's dose guidance is category 1 A. Then the received skin dose is equal or less than 1 % of the skin dose legally permitted for radiation workers (300 mSv). 10 skin contamination events could be allowed, if category 1 B is the commander's guidance and up to 50 contamination events if categories 1 C to 1 E were issued as guidance. Instead of going up to 100, the number 50 was chosen to take into account that in 50% of the events it is perhaps not possible to reach the 10 Bq/cm² level by decontamination. With this restriction, a skin dose of 300 mSv should not be exceeded.

Table 3-M: Maximum Contaminated Limits

	Equipment and protective clothing				Skin
	High-tox alpha emitters⁵		Beta and low-tox alpha emitters⁵		Beta only
	Bq/cm²	Dpm/100c m²	Bq/cm²	dpm/100c m²	Bq/cm²
NATO PROPOSED GUIDANCE - 7 day Mission					
Category 1A (.05-.5 cGy)	5	3 x 10 ⁴	50	3 x 10 ⁵	10 (once only)
Category 1B (0.5-5 cGy)	50	3 x 10 ⁵	500	3 x 10 ⁶	10 (10 times)
Category 1C (5-10 cGy)	100	6 x 10 ⁵	1000	6 x 10 ⁶	10 (50 times)
Category 1D (10-25 cGy)	250	1.5 x 10 ⁶	2500	1.5 x 10 ⁷	10 (50 times)
Category 1E (25-70 cGy)	700	4.2 x 10 ⁶	7000	4.2 x 10 ⁷	10 (50 times)
NATO PROPOSED GUIDANCE - 3 Month Mission					
Category 1A (.05-.5 cGy)	0.5	3 x 10 ³	5	3 x 10 ⁴	10 (once only)
Category 1B (0.5-5 cGy)	5	3 x 10 ⁴	50	3 x 10 ⁵	10 (10 times)
Category 1C (5-10 cGy)	10	6 x 10 ⁴	100	6 x 10 ⁵	10 (50 times)
Category 1D (10-25 cGy)	25	1.5 x 10 ⁵	250	1.5 x 10 ⁶	10 (50 times)
Category 1E (25-70 cGy)	70	4.2 x 10 ⁵	700	4.2 x 10 ⁶	10 (50 times)
US STANDARDS					
Reg Guide 8.21 (unrestricted area)	0.0037	22	0.037	222	
Reg Guide 8.21 (restricted area)	3.7	2.22 x 10 ⁴	37	2.22 x 10 ⁵	
Reg Guide 8.23 values for equipment contamination	0.0333	200	0.17	1000	
NRC & ANSI	0.0033	20	0.17	1000	
Notes:					
1. Radiation contamination is assumed to be removable.					
2. If one cannot determine alpha emitting isotope, use high-tox alpha emitter column.					
3. Handling of contamination equipment without wearing protective clothing is allowed only in category 1A.					
4. Skin decontamination should begin when the measured levels greater than 10 Bq/cm ² or when the activity cannot be reduced by more than 10% in 1 decontamination step after 2 or 3 decontaminations were performed.					
5. NATO Working Group 2 has recently defined forms of uranium (enriched, natural, and depleted uranium) as "low-tox." All other alpha emitters were defined as "high tox."					

Reference: WG.2 Contamination Limits, Reg Guide 8.21, and Reg Guide 8.23.

6. Additional information on the properties of the skin.
 - A. The skin is an effective barrier, but not completely impermeable against radioactive substances. Such substances can enter the horny layer of the skin and transport into deeper layers of the horny layer of the skin or even into the blood circulation system. However, the activity concentration decreases exponentially with depth. Within a regular cycle of about 2 weeks, the complete horny layer of the skin peels off and is replaced by a new layer. This leads to a very rapid and strong decrease of the activity remaining in or on the skin.
 - B. For conservative estimates it is assumed that after a contamination event the material having an initial activity of 10 Bq/cm² remains on the skin for duration of 1 week. Then it can be shown that for virtually all radionuclides that are relevant for radiation protection considerations a dose value of 3 mSv is not exceeded.

3.17. Radiation Units

1. *Exposure.* *Exposure* in the field of radiation protection has two meanings. First it is the dictionary definition - the state of being exposed. The second is the very specific scientific definition of the sum of the charges of one sign produced in 1 kg of air by photon irradiation. In the SI system exposure is measured in Coulomb per kg of air (C/kg). In the traditional system the special unit roentgen (R) has been defined where $1 \text{ R} = 2.58 \times 10^{-4} \text{ C/kg}$.
2. *Absorbed Dose.* The *absorbed dose* is the amount of energy deposited in a given mass of absorbing material and is symbolized by D. This quantity can be measured for any kind of radiation and any energy. In the SI system we measure it in units of Gray (Gy) and 1 Gray = 1 J/kg. In the traditional system absorbed dose is measured in units of rads and 100 rads = 1 Gy and 1 rad = 1 cGy. Dose means the total amount of energy absorbed. The exposure could be single or multiple and either short or long in duration. This document uses cGy.
3. *Dose Equivalent.* Experiments have shown that different types of radiation cause more biological damage even if the total energy deposited is the same. We find that 1 cGy of alpha radiation causes more biological damage than 1 cGy of gamma radiation. So we define a new quantity designed to measure actual biological damage. This quantity is the *dose equivalent* and is defined as the energy deposited per unit mass of absorber multiplied by a quality factor that accounts for the different biological effects of the different types of radiation. The dose equivalent is measured in Sieverts (Sv) in the SI system and in rem in the traditional system. 1 Sv = 100 rem. See 10 CFR 20 Table 1004(b)2 for the quality factors used by the NRC.
4. *Dose Rate.* Dose rate is the dose of radiation per unit time. This document uses cGy/hr.
5. *Conversion factor.* A common “conversion factor” between exposure, absorbed dose, and dose equivalent is 1 R = 1 rad = 1 rem. This is an estimate that for radiation protection purposes is close enough (it actually over estimates the dose and therefore is a conservative estimate). The actual conversion is 1 R = 0.96 rem in tissue. *Note that this method works only where the roentgen is defined - for photons of energy less than 3 MeV.* When dealing with particulate radiation other methods must be used.
6. *Activity.* The activity level of a radioactive material is expressed as the number of atoms that will disintegrate (decay) per second. One becquerel (Bq) is equal to one nuclear transformation per second. The unit in the

traditional system is curie, where 1 curie (Ci) = 3.7×10^{10} becquerels.

7. *Concentration and Isotope.* The exposure rate from a radioactive material is related directly to the amount or quantity of the material present. Quantity of radioactive material will be expressed in units depending upon the medium of the radioactive material. For example, for the measure of radioactive material in air, the units are microcuries per cubic meter ($\mu\text{Ci}/\text{m}^3$) or becquerels per cubic meter (Bq/m^3). For ground measurement, the units are microcuries per square meter ($\mu\text{Ci}/\text{m}^2$) or becquerels per square meter (Bq/m^2). Field measurements of quantity are normally expressed in instrument-dependent units of counts per minute (CPM) or counts per second (CPS) and must be converted to definitive units such as $\mu\text{Ci}/\text{m}^2$ or Bq/m^2 for meaningful comparison. Section 3.1 mentions several organizations that can provide assistance for these calculations.

3.18. Radiological Detection Equipment

1. U.S. Army Radiological Detection Equipment is detailed in the equipment chapter.
2. Human senses do not respond to ionizing radiation. Accordingly, special instrumentation must be used for radiation detection and measurement. Since the degree of hazard from radiation to humans depends on the type of radiation, its energy spectrum, as well as the quantity to which a person has been exposed, radiation detectors used in the field must be capable of making qualitative as well as quantitative measurements.
3. No single instrument at present has all the desired characteristics. Accordingly, different types of instruments must be used depending upon the nature of the radiation hazard. The characteristics of some of the more commonly used detectors are summarized below.

A. Ionization Chambers. Ionization chambers measure dose and dose rate from gamma and x-radiation. A typical ionization chamber that measures total dose is the pocket dosimeter. It is the size of a large fountain pen. It has a chamber containing a quartz fiber loop that is free to move with respect to its mounting. Radiation entering the chamber causes ionization within the sensitive volume. The distance the fiber moves is proportional to the dose received in the chamber. Instruments of this type are sensitive to shock and humidity and small enough to be worn comfortably. An advantage of this instrument is that it can be read at any time without the aid of a supplementary charger-reader by simply holding it up to a source of light and looking into it.

B. Geiger-Mueller Counter. Geiger-Mueller counters are normally used for detecting single ionizing events that take place within the sensitive volume of the counter. They are very rugged and sensitive to low levels of radiation. They are usually equipped with audible detection of radiation in the form of "clicks." Geiger-Mueller counters detect gamma photons or beta particles. Detection of gamma rays is less efficient than of beta particles. A discriminating shield is usually provided with Geiger-Mueller instruments. When the shield is open, the instrument measures both beta and gamma radiation. When the shield closed, the instrument measures only gamma. Use of the shield may permit qualitative differentiation between ionization caused by beta particles and that produced by gamma photons. The sensitivity of Geiger-Mueller counters to alpha radiation depends on the window thickness. Geiger-Mueller counters, as a class, are energy dependent.

C. Proportional Counters. Proportional counters are used to detect one type of radiation in the presence of other types of radiation or to obtain output signals greater than those obtainable with ionization chambers of equivalent size. Proportional counters may be used to either detect events or to measure absorbed energy (dose), because the output pulse is directly proportional to the energy released in the sensitive volume of the counter. Proportional counters are most widely used for the detection of alpha particles, beta, neutrons, and protons.

D. Scintillation Counters. A scintillation counter combines a photomultiplier tube with a scintillating material, which may be a crystal or other phosphor (solid, liquid, or gas). Light pulses produced in the scintillator by radiation release photoelectrons from the cathode of the photomultiplier tube, which then initiates pulses of current that can be counted. Scintillation counters are available that can detect alpha and beta particles, gamma rays, neutrons, protons, and electrons. The most common counters for field uses are those employed as alpha counters or as gamma detectors. Scintillation counters may be very energy dependent depending on the scintillating material. Scintillation counters are more efficient at detecting low level gamma backgrounds than are Geiger-Mueller counters.

3.19. Radiological Surveys

1. Reference: FM 8-9 (Part 1, Annex A).
2. General. The primary purpose of performing radiological surveys is to determine the extent of any existing health hazards, establish protective control boundaries, and provide data on which to base decontamination requirements.

A. Types of Surveys. Various types of radiological surveys may be performed. Area surveys may involve the determination of fallout patterns on the ground, levels of airborne activity, or contamination patterns on ships or in buildings. Personnel surveys are performed to detect the presence of contaminated material on the body's surfaces, in body openings, e.g., nose and ears, or in the case of casualties with traumatic injury, contamination in wounds. The results of personnel surveys are used to evaluate health hazards and to establish decontamination requirements. Equipment/material surveys are conducted primarily to establish requirements for decontamination. Monitoring should be done with consistency (1-2 cm from surface for alpha and beta and 1 meter from surface for gamma).

B. Levels of Surveys. The level or technical depth of surveys will differ depending on the intent of the survey. Radiological surveys for health risk analysis are time consuming and very technical. They usually include external radiation readings using meters, soil sampling, water sampling, and air sampling. USACHPPM's TG 236 outlines various survey protocols for a variety of different situations. Please refer to that document or contact USACHPPM for guidance when conducting radiological surveys. Please call the organization that will do the analyses and risk assessment of the samples before collection begins. Samples that are not collected according to a specific health risk assessment plan are useless for low level analysis. Surveys to determine the extent of external gamma radiation hazards after a large incident or nuclear explosion are less technical and do not require sampling. The protocol for such a survey is given in the following section.

3. Area Screening for Gamma Radiation. The results of area surveys are used primarily to establish protective control boundaries.

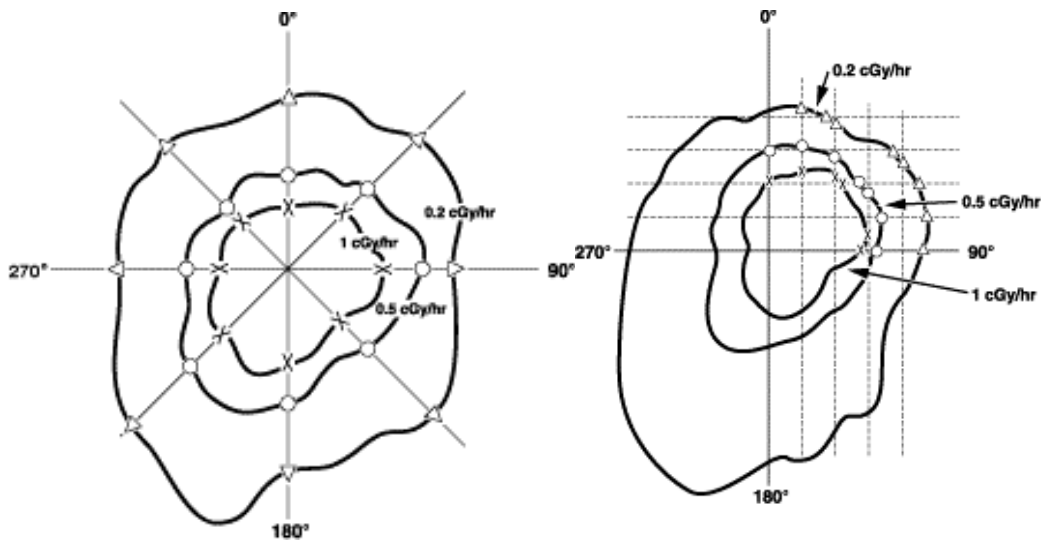
Figure 3-E: Radiation Survey Techniques. Radial Plot (left) and Grid Plot (right)

Reference: Figures A-II and A-III from FM 8-9 (Part I).

A. The performance of a radiological survey may be divided into two phases: a preparatory phase, and an execution phase. The preparatory phase involves the selection, testing, and if necessary, calibration of survey equipment to be used; the acquisition of materials necessary for recording survey results, establishing communication links between the survey team and survey command center, and finally the outfitting of personnel who are to perform the surveys. Outfitting may involve the use of protective clothing.

B. A variety of techniques may be used in performing a radiological survey. Which specific techniques are employed will depend on the operational situation. However, certain basic principles can be described that are applicable to area, personnel, and equipment/material monitor surveys. These principles are outlined below.

C. The principle objective in an area survey is to establish the location and radiation levels associated with one or more isodose rate lines. An isodose rate line is a plotted contour line that depicts the location of some uniform level of radiation or radioactive contamination.

D. Two methods of plotting isodose rate lines are illustrated in above figure. The radial plot is the simpler of the two and can be done quickly with minimum personnel. The grid system is more accurate, but it is time consuming and requires a large number of personnel to cover a large area. In practice, both methods might be employed using the best features of each system. The radial plot is used to establish the isodose rate line boundaries and the grid system is used to plot heavily contaminated areas in detail. Care must be used in selecting a focal point for a radial plot as the entire contamination area may be missed. Whatever system is used, the following rules must be observed: Isodose rate lines must always close, Isodose rate lines cannot cross each other, and Isodose rate lines can cross a survey line only at a data point.

E. To perform an area survey, personnel move into an area until the radiation level established as a guide in the preparatory phase is reached. That point is then designated on a map. Following the readout from the radiation instrument, the isodose rate lines for that radiation level is followed

to the left or right as terrain dictates until the isodose rate line closes. That is until the survey team having moved to its right eventually returns to the location in which the first reading was taken and plotted. Having completed this isodose rate line, higher or lower levels of activity are selected and other isodose rate lines are established.

F. The report of an area survey should include the name of survey team members, the date and time that the survey was performed, and the type of radiation detection equipment used in the survey. It should also contain the calibration date, and other remarks that may be helpful in evaluating the attached survey plot.

G. While area surveys are generally considered as passive surveys, i.e., actions taken based on survey results may be deferred for hours or days, personnel surveys are active, in that actions taken to remove contaminated materials from body surfaces are usually taken immediately. Because they are active surveys, the locations of the contamination on body surfaces are not usually plotted, as is the case in area surveys. Instead, contaminated areas are identified with tapes, dyes, magic markers, etc., on the body surface itself.

4. Personnel Survey. In performing a personnel survey, the individual to be monitored stands, with legs spread and arms extended. The radiation monitor begins the survey at the head, subsequently surveying the upper trunk, arms, lower trunk, and legs. The individual being surveyed is asked to do an about face, and the procedure is repeated. As in area surveys, care must be taken not to permit the detector probe to touch any potentially contaminated surfaces. When a contaminated area is identified, it is marked. If it is suspected that contamination may have entered a body opening or wound, swabs may be used to collect surface material. These swabs may then be checked with a radiation detector appropriate to detect the isotope of concern. Personnel survey records should indicate the name of the individual surveyed, the sites and levels of any activity detected, and the nature of any instructions given to the contaminated individual concerning decontamination procedures.
5. Equipment/material Surveys. Equipment/material surveys are performed in a manner similar to that used for area surveys. Hand sketches of the object to be surveyed are prepared. Surveying begins at the lower and outer surface of the object to be surveyed and progresses in an upward direction until the object is completely surveyed. Areas of contamination and levels of activity identified are noted on the sketch. Survey records developed from equipment/material monitoring are similar in their information content to those prepared for area surveys.
6. Radiological Survey Briefing.
 - A. Situation: Enemy and contamination situation.
 - B. Mission: Who, what, when, where, and why.
 - C. Execution:
 - (1) Concept of operation.
 - (2) Assignments.
 - (3) Coordinating instructions: departure time, primary and alternate routes, coordination required, OEG, turn-back dose, turn-back dose rate, actions on reaching OEG, turn-back dose, turn-back dose rate, Areas requiring marking, and debriefing - when, where, by whom.
 - D. Service Support: Forms, equipment, protective equipment, and decontamination.

E. Command Signal:

- (1) Command. location of control party.
- (2) Signal: reporting requirements, codes and call signs, primary and alternate communication means.

3.20. Dosimetry

1. References: AMEDD Center and School's GR 76-332-200, FM 3-3-1, FM 8-9, TM 11-665-214-10, and TM 11-665-236-12.
2. General. Dosimeters measure the total dose of external radiation to which the device is exposed. Dosimeters are usually worn by personnel thereby measuring the external dose to that individual. Dosimetry is necessary since the medical effects of radiation may not manifest themselves for days, years, or even decades. There are several types of dosimeters.

A. Chemical Dosimeters. Chemical dosimeters are systems in which measurable chemical changes are produced by ionizing radiation. Radiation produces acids in the system, the amount of which can be determined from visible color changes, or, more accurately, by titration or pH readings. Most chemical systems of practical size are useful only for gamma doses of hundreds to millions of cGy. However, small volume detectors can be found which measure doses in the range of a few cGy to several thousand cGy.

B. Photographic Emulsions. Photographic emulsions are frequently used as detectors. The film badge has been the most common dosimeter in use, but is tending to be replaced by thermoluminescent dosimeters (TLD). The film badge uses the effect of radiation on photographic film to record dose. After film developing, the optical density is compared to a film calibration curve, and a measure of exposure dose is obtained. As the exposure dose increases, the optical density of the emulsion increases. At least two different types of film are employed to cover a wide-exposure range; a low exposure film, 0.02 cGy to 2 cGy and a high-exposure film, 1 cGy to 1,000 cGy. Metal filters such as aluminum, copper, and cadmium-tungsten, are used to increase the accuracy in the reading. The heavy metal filter also intensifies the gamma radiation interaction. Beta radiation is evaluated by observing the density change to a portion of film that is not covered by a filter. Film badges or TLDs are widely used as they provide an accurate means of recording radiation exposure at a low cost. A disadvantage of film badges is that heat, moisture, and aging will cause a natural change in the films optical density.

C. Thermoluminescent Dosimeters. Thermoluminescent dosimeters (TLDs) detect radiation by the formation of a crystalline structure. Ionizing radiation excites electrons to a state within the crystal structure, which can be detected by heating the crystal. When heated, the electrons are released from these traps and return to their lowest energy state with the release of light. The amount of light released is proportional to the radiation exposure. Radiophotoluminescent (RPL) glass is a dosimeter material that will luminesce following an excitation pulse of ultraviolet light if it has been exposed to ionizing radiation. This effect is caused by radiation induced changes in the glass crystalline electronic structure. Although other materials also exhibit this property, silver activated RPL glass has found the greatest application in x and gamma radiation dosimetry. The sensitivity depends on the type and manufacturer selected, and ranges from 0.01 cGy to several million cGy. This type of dosimeter cannot be zeroed; it gives a total cumulative dose reading

that fades only very slowly with time. Silicon diodes are most useful for high-energy neutron dosimetry. Neutrons reacting in the diodes cause displacement of atoms in the silicon crystal, which results in a relatively permanent and measurable change in its electronic resistance. These dosimeters are almost totally insensitive to x and gamma radiation and have a practical range of 1 to 1000 cGy depending on the type selected.

D. Pocket Dosimeters. The pocket dosimeter is about the size and shape of a large fountain pen and is worn on the trunk portion of the body. It is a direct reading instrument and provides interim radiation exposure information and should be used in conjunction with a TLD rather than in lieu of TLD use. The pocket dosimeter consists of an ionization chamber. This chamber is sensitive to gamma radiation. Pocket dosimeters usually have a range from 0 to at least 0.2 cGy. Its indicator is an image of an electrometer fiber on a calibrated scale. Pocket dosimeters lose their electrical charge over time. When a pocket dosimeter is "zeroed", it has a full electrical charge. Loss (leakage) of this charge changes the reading on the dosimeter and can be misconstrued. This can give a false indication of radiation exposure causing personnel to assume that they have been exposed to an excessive amount of radiation and, in turn, to result in cessation of operations and time consuming investigations. The use of two dosimeters by personnel can prevent false interpretation of an individual's exposure. When practicable, use two pocket dosimeters and assume that the lower reading is the actual exposure. Proper operation of pocket dosimeters is documented through periodic recalibration by USAIRDC. If a dosimeter is suspected of having excessive leakage the following procedure should be followed. Recharge the dosimeter and leave it in a background radiation area for a period of 24 hours. After this time lapse, recheck the dosimeter. If leakage exceeds two percent of full-scale, the test should be repeated. If the dosimeter again leaks at an excessive rate it must be considered defective and turned in for calibration. Each dosimeter should be read immediately prior to operations to check for excessive leakage and should be subjected to the above leakage check at monthly intervals.

3. Use. Dosimeters are delicate instruments and should be treated as such. Jarring or dropping this instrument may cause a high reading or result in breakage of the quartz fiber electrodes. Also, excessive humidity may cause a high reading. If damage to the dosimeter is suspected, personnel should immediately notify their supervisor.

A. Thermoluminescent dosimeter (TLD) badges used to provide a permanent record of the cumulative exposure to the whole body must be worn on the trunk (below the shoulders and above the hips) outside of clothing on the portion or area of the body nearest the radiation source. The dosimeter window must face out from the body.

B. Pocket dosimeters provide direct-reading capability that allows the dosimeter to be read at any time while working in a radiation area to get an estimate of the exposure received. The pocket dosimeter shall be read and doses recorded daily in the utilization log. If, at any time, dosimeters read off scale, an emergency situation is considered to exist and the individual's TLD badge and the control badge must be submitted immediately for processing.

4. Army Dosimetry Service. Army activities, to include reserve forces, are required to use the Army dosimetry service provided by the USAIRDC. Organizations initiating industrial radiography operations should contact USAIRDC in advance to assure receipt of dosimeters prior to the date on which such operations are scheduled to commence.

5. Army Dosimeters. For field operations, the Army uses two types of dosimeters. See the equipment chapter for more information.

6. Radiation Exposure Records

A. The OEG concept requires that all units maintain radiation exposure. Because platoons are usually located in areas of equal radiation levels, the most realistic unit exposure data are based on readings obtained at the platoon level. Radiation exposure records are maintained at all levels. Battalion S1, in coordination with the battalion NBC staff, maintains RES records for all assigned and attached units. The records are based on platoon level data received daily or after a mission in a radiological contaminated area. Unit SOP indicates specific reporting procedures. Monthly records are maintained according to unit SOP. FM 3-3-1, Figure A-2 shows a suggested way of maintaining RES data for each company within a battalion (companies maintain records by section). A blank radiation exposure chart, DA 1971-6-R, is in Appendix H of FM 3-3-1.

B. Unit Dosimetry.

(1) The data from each platoon-size element are passed to the unit NBC defense team. The defense team averages the readings from tactical dosimeters (IM93s or DT236s) on a daily basis and keeps an informal record maintained at platoon and company level. The IM93s are recharged after each report is submitted or every three days, whichever occurs first. For the DT236, prior to radiological operations, each unit will read 10 percent of the total number of DT236 weekly to ensure no leakage has occurred. After radiological operations have commenced in the theater of operations, one third of the total number of DT236s will be read daily. During this response time of the DT236, readings should be obtained with the IM93 dosimeters and used for planning purposes. The readings from the DT236 will be used for determining unit RES. After recording all platoon information, the company reports platoon and company status to the battalion according to its SOP.

(2) Battalion records and maintains the status on each platoon, company, and attached elements. An overall battalion status is reported to the S3 or placed on the daily briefing chart. Battalion then forwards the company and overall battalion status to brigade. Brigades maintain records on all company-size elements as well as battalion overall RES. This information generally is collected at the brigade administrative and logistics center with the brigade S1. Brigade NBC personnel must ensure this information is collected, tabulated correctly, and maintained. Typical flow of dosimetry within a division is shown in FM 3-3-1, Figure A-3.

(3) Since the platoon is the lowest level at which radiation exposure records are kept, replacements should be at platoon level. An ineffective platoon is either pulled out of a company, or the personnel are reassigned to different platoons with the same RES. A new platoon is then assigned to the company. This creates severe management problems for personnel replacement. All levels of command must follow these procedures. It may be difficult, but it keeps personnel from becoming incapacitated due to overexposure to radiation.

C. Individual Dosimetry. As an interim measure until the Army issues the DT236 individual dosimeters to each soldier, the dose of the soldier is assumed to be the same as the platoon or similar size unit to which the soldier is assigned. When reassigned or evacuated through medical or other channels, the soldier's dose will be assumed to be the same as the platoon or similar-size

unit to which last assigned. A notation of this status (RES-0, RES-1, RES-2, RES-3) will be made on the soldier's official records for formal record of radiation exposure when the individual is passed on to a gaining unit.

3.21. Bioassay

1. Bioassays should be conducted whenever there is a possibility of internal contamination. Such situations include being in or near a vehicle as it is hit by a DU round or after it has been hit, climbing on such vehicles before they are completely decontaminated, or being in a room when a firing control device containing tritium breaks. Because of the its advanced armor, munitions that penetrate the armor of a M1 should be assumed to be DU. Also assume all tanks and vehicles killed by US forces are contaminated with DU and radium. USACHPPM's TG 211, Radiobioassay Collection, Labeling, and Shipping Requirements, contains the procedures for submitting a bioassay sample.
2. Radiological Bioassay is defined as the determination of the kind, quantity, or concentration, and location of radioactive material in the human body by direct measurement or analysis of materials excreted or removed from the body. Bioassay programs are designed to identify potential health problems that may arise to individual workers, evaluate the effectiveness of radiation protection programs, and assure compliance with regulations. Direct bioassay (In-vivo) includes whole body counting or organ counting, and indirect bioassay (In-vitro) includes urinalysis, fecal analysis, or other.
3. The USACHPPM is responsible for providing bioassay support. Specimens for bioassay are collected at medical treatment facilities by occupational health professionals and sent to USACHPPM for analysis and dose assessments.
4. A dose assessment report is produced and sent to the medical treatment facility that initiated the request and submitted the specimen, the NRC license manager, and the USAIRDC. The report sent to the medical treatment facility is placed into the individual's medical record. The report sent to the NRC license manager is archived. The report sent to the USAIRDC is combined with any external dose in order to provide the NRC annual dose history. The USAIRDC archives the report for at least 75 years.

3.22. Radiological Basics

1. References: AMEDD Center and School's NBC General Reference for the Officer Basic Course, FM 3-7, FM 8-9 (Part I), and FM 8-10-7.
2. *Radioactivity* is a spontaneous nuclear transformation that results in the formation of a different element and, usually, the release of excess energy as particulate and/or electromagnetic radiation. For example, tritium transforms into He-3 and emits a beta particle. The *activity* of a sample is the rate of radioactive transformation and is usually symbolized by the letter A. In other words, the number of nuclear transformations occurring in a given time. There are two systems of units commonly used for radiological measurements: the International System (SI) and the Traditional units. In SI units, activity is measured in becquerels (Bq) where $1 \text{ Bq} = 1 \text{ transformation per second}$. In the traditional units, activity is measured in curies (Ci) where $1 \text{ Ci} = 3.7 \times 10^{10} \text{ transformation per second} = 3.7 \times 10^{10} \text{ Bq}$. The *specific activity* is defined as the activity of the

source divided by either its mass or its volume. Therefore, specific activity is measured in units such as Bq/g or Bq/mL in the SI system and Ci/g or Ci/mL in the traditional units. Of course, the multipliers are often used to make the units more readable (for example: mCi/mL, Bq/kg, etc.)

3. Half-life (T) of radiological material: If we look at a sample of a *radionuclide*, we will find that after some amount of time one-half of the original number of atoms will have made the transformation. This time is called the *half-life*. After another half-life has passed we will again find that one-half of the atoms have transformed (leaving $\frac{1}{4}$ of the original number). Each radionuclide has a unique half-life. For example, tritium has a half-life of 12.3 years while Uranium-238 has a half-life of 4.47 billion years.

Figure 3-F: The Transformation of a Radionuclide over time

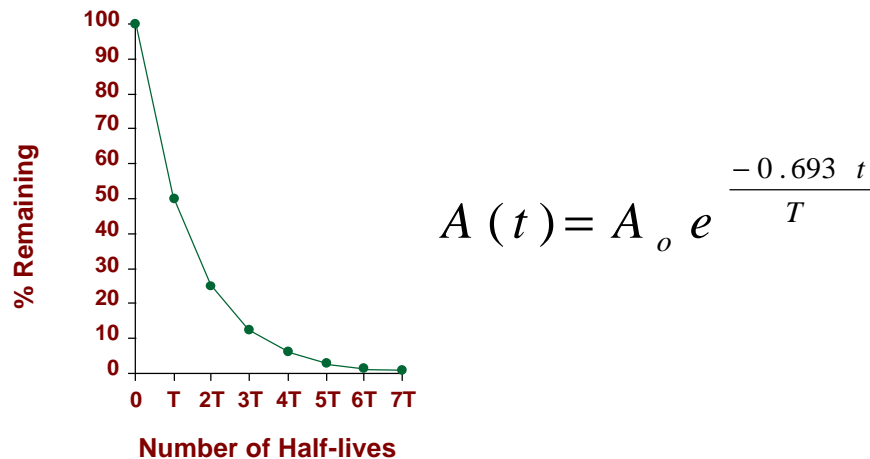

4. Types of Radiation.

A. A nucleus can decay by emitting several different types of particles. The most common forms of radiation are gamma, neutron, beta, and alpha. Many radioactive isotopes decay through various channels and emit several forms of radiation at once. For example, in any decay, the nucleus is usually emits a gamma in addition to any alpha or beta emitted.

B. Gamma. Gamma radiation is highly energetic and penetrating photons. It is similar to visible photons but are of high energy. Gamma radiation can penetrate through skin and clothing and therefore is both an internal and external hazard. If the gamma photon flux is high and the whole body is exposed, a fairly homogeneous deposition of energy over the entire body occurs.





C. Neutron. Neutron radiation can result in whole-body irradiation. The energy deposition will not be uniform, and the side of the body that faces the detonation will absorb more energy than the opposite side. The major effect of this non uniform deposition of energy will be to cause a wide variation in the typical radiation doses causing radiation sickness rather than significant variation in the overall clinical effects.

D. Beta Radiation. High-speed electrons in the form of beta radiation lose most of their energy after penetrating only a few millimeters of tissue. If the beta emitting material is on the surface of the skin, the resulting beta irradiation causes damage to the basal stratum of the skin. The lesion is similar to a superficial thermal burn. However, if the beta material is incorporated internally, the beta radiation can cause significant damage. The damage will be in spheres of tissue around

each fragment or source of radioactive material. The distribution is determined by the chemical nature of the material.

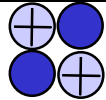
E. Alpha. Alpha radiation is fully absorbed within the first millimeter of an exposed tissue mass. If the source of the alpha radiation is external to the body, all of the alpha radiation is absorbed in the superficial layers of dead cells. If anything, even tissue paper, is interposed, the alpha particles will be absorbed, and not reach the skin. Because of this, alpha radiation is not an external hazard. If alpha-emitting material is internally deposited, all the radiation energy will be absorbed in a very small volume of tissue immediately surrounding each particle. Internal deposition of alpha particles can cause radiation injury on a long-term basis.

Table 3-N: Characteristics of Nuclear Radiation

Name and Symbol	What is it	Source
alpha particle α	Helium nucleus 	Decay of uranium and plutonium
beta particle β	High-speed electron 	Fission products and neutron induced elements
gamma ray γ	Electromagnetic energy 	Decay of fission products and neutron induced elements
Neutron	Uncharged particle 	Fission and fission reactions, Am-Be sources

Reference: Table 2-8 from FM 8-10-7.

Table 3-O: More Characteristics of Nuclear Radiation

Name and Symbol	Range in air	Range in tissue	Shielding required	Biological hazard
Alpha particle α	5 cm	Cannot penetrate the skin	None	None, unless ingested or inhaled
Beta particle β	5 meters	Several layers of skin	Stopped by moderate clothing	Possible skin injury. Internal hazard if inhaled or ingested
Gamma ray γ	Up to 500 meters	Very penetrating	Dense material, such as concrete, steep plate, earth	Whole body injury, many casualties are possible
Neutron	Less than gamma	Very penetrating	Hydrogenous materials, such as water or damp earth	Whole body injury, many casualties are possible

Reference: Table 2-8 from FM 8-10-7.

3.23. Internal Irradiation

1. Reference: FM 8-9 (Chapter 5 of Part I).
2. General. When radioactive materials are incorporated into the body and retained, significant radiation injury can be sustained by specific tissues in which the materials are concentrated or in some instances by the whole body. The primary factors that determine the type and degree of injury are the types and amounts of the isotopes deposited and the nature and energies of the radiation emitted. Isotopes of a given element follow a fairly specific biological pathway in the body. More than one isotope may be incorporated in the body at the same time, and the effects of a mixture of isotopes found in fallout would be additive.
3. Incorporation of Radioactive Materials. The basic routes of entry for isotopes are inhalation, ingestion, and absorption through the skin. Other paths are injection as penetration of a foreign object and open wounds. Following ingestion or inhalation, a given material may be absorbed into the blood stream, depending upon its solubility. Insoluble materials are not absorbed, except in extremely small amounts, and may be eliminated fairly rapidly directly from the respiratory and gastrointestinal tracts. However, under certain circumstances, insoluble materials can be retained at or near the original site of deposition, e.g., in the lungs or in wounds, or may be translocated to regional lymph nodes, where again they will constitute an internal radiation hazard. Only the very small particles of radioactive materials, 10 microns in diameter or smaller, are deposited in the alveolar airsacs.

A. Inhalation. An insoluble material that is inhaled in the form of an aerosol will be deposited along the tracheobronchial tree. Much of it will be removed by the ciliary action of the mucosa lining of the respiratory system, but a certain fraction, depending on the size, shape, and density of the particles, will penetrate down to the alveolar airsacs and remain. Only the very smallest particles penetrate that far; and so, the percentage of inhaled insoluble particles that are retained in the lungs is small, generally less than 25%. However, material so retained can be a considerable hazard to the lung, since it may remain for a long time. A portion of this material will be picked up by the lymphatic system draining the various pulmonary regions. It will then be collected by and remain in the lymph nodes of the lungs and still be a long-term hazard to lung tissue. A small fraction of the material may reach the blood stream and end up trapped in the reticuloendothelial system in various regions of the body and for certain isotopes, such as plutonium and strontium, also in bone. If a soluble material is inhaled, it is absorbed very rapidly and completely, and often will not remain in the lungs long enough to cause significant damage. Once in the circulation, it will be distributed in the body in the same way, as it would follow any other mode of entry.

B. Ingestion. An insoluble material that is ingested will remain in the gastrointestinal tract and become mixed in and part of the fecal material in the large bowel, with which it will then be eliminated. This includes swallowed material cleared from the upper respiratory tract and the tracheobronchial system by ciliary action. Insoluble material is not retained in the gut as it is in the lungs or in soft tissues, and the radiation hazard is limited in time to that required for transit and elimination, generally a matter of hours. As a result, the radiation hazard is negligible, unless the material includes a highly active gamma emitter. Normally, beta and alpha radiation from insoluble radioactive material in the gut lumen will not cause significant damage. The few cells of the mucosa that are damaged slough off and are replaced rapidly. Highly radioactive fallout

containing fission products emitting beta and gamma radiation could cause some gastrointestinal tract damage if accidentally ingested with contaminated foodstuffs or water. However, in most such instances, the whole-body exposure received from external gamma radiation in the area would be the controlling hazard. When a soluble material is ingested, absorption is quite efficient. This is the most significant route of entry for the soluble isotopes in fallout, particularly when fallout-contaminated water or food is consumed. A number of fission products can become incorporated into vegetation and enter into complex food chains. In some instances, certain radioactive materials can be concentrated in these chains increasing the eventual hazard to humans.

C. *Transcutaneous Absorption.* An insoluble material contaminating the intact skin can be an external hazard only if it is a neutron, gamma, or beta emitter. It will not be absorbed into the blood stream and thus will not become an internal hazard. Conceivably, contamination of the skin with large quantities of gamma emitting materials could result in significant whole-body irradiation. This could occur when personnel have been subjected to heavy fallout contamination. However, this can be easily prevented by prompt removal of contaminated clothing and washing exposed areas of skin. If a wound is contaminated, insoluble material will tend to remain localized in the tissue at the wound site, unless removed by debridement. Some would be present within the eschar. This type of contamination should not cause a serious problem, unless it is particularly high in radioactivity. Soluble material will be absorbed readily through wound sites and distributed within the body organs and tissues according to the usual metabolism of the stable isotope of the element in question. Some soluble materials, particularly tritium, will be absorbed rapidly and totally across the intact skin.

4. Elimination of Isotopes.

A. A radioactive material must be eliminated from the body to remove its hazard. Detoxification, which is effective against chemical hazards, will not be effective since radioactivity is not modified by chemical changes. The methods of elimination include renal excretion for most soluble materials, elimination in the feces for materials that are retained in the gut or which can be secreted in the bile, and exhalation for volatile materials and gases. Chelating agents, e.g., calcium or zinc DTPA (diethylenetriamine pentaacetic acid), if administered soon after exposure, are effective in enhancing the elimination of certain radioisotopes. These materials are not very effective for radioisotopes that have been incorporated and fixed in organs and tissues, e.g., bone.

B. The rate at which a material is eliminated is usually expressed as the biological half-life. Not all materials follow a simple exponential elimination process, but this method of expression is sufficiently accurate to be applicable to most soluble isotopes. An exception that must be noted is the retention of insoluble heavy metals such as plutonium in the lungs and in bone. The rates of loss under these circumstances are not exponential and are very slow. The biological half-life may be variable. A prime example of this is body water, the turnover of which can be as short as 4 days to as long as 18 days depending upon the state of hydration, volume of intake, and renal function. If tritiated water is incorporated into the body, the biological half-life is the factor determining the hazard since it is so much shorter than the physical half-life of about 12 years. Reduction of the biological half-life to a minimum by overhydration and the administration of diuretics have obvious value and is the recommended therapy in cases of exposures to tritium. Other isotopes cannot be cleared from the body as rapidly, and there is no adequate treatment

available at present for increasing the rate of removal of a mixture of isotopes which would be incorporated into the body as a result of ingesting fallout contaminated food and water.

C. The overall radiological hazard of materials that are eliminated exponentially will be a function of their physical and biological half-lives considered together. Whichever is shorter will become the primary factor. The effective half-life is usually determined and expressed by the following formula:

$$\text{Effective half - life} = \frac{\text{Biological half - life} \times \text{Radiological half - life}}{\text{Biological half - life} + \text{Radiological half - life}}$$

D. The uptake by the body of radioisotopes can be blocked in some cases. For example, potassium iodide or iodate if given prior to or soon after an intake of radioiodine, will reduce the uptake of radioiodine by the thyroid gland. Similarly, orally administered Prussian Blue will reduce the absorption of cesium from the gut and Alginate will reduce strontium absorption. No policy exists which would allow for NATO forces to stock and issue chelators.

3.24. Radioactive Materials

1. References: FM 8-9 (Part I), Guide to Medical Considerations in NBC Battlefield Operations (1st Draft), USACHPPM's TG 238, NCRP Report No. 65, and ACALA's *Radioactive Material Handling Safety*.
2. Americium-241. The most likely use of Americium-241 is with Am-Be as a neutron source. These are used in moisture density gauges, the M8A1 Chemical alarm, lead paint analyzers, and many smoke detectors. Americium-241 is also used to ensure uniform thickness in rolling processes like steel and paper production, and to help determine where oil wells should be drilled. Americium-241 does not occur in nature. It is a progeny of the decay process of Plutonium-241 with a half-life of 458 years and is primarily an alpha and gamma emitter. The gamma radiation for this isotope is very low, so an external dose could not be received unless large amounts of Americium-241 are stored in one area and a person is in close contact with the material for most of the work day. The high-energy alpha emission can present an internal radiation hazard if it is ingested. Americium-241 is chemically analogous to calcium and can replace calcium in the body, especially in bone material. For this reason it is often referred to as a "bone seeker." Once incorporated in the bone, the bone and surrounding tissue are constantly irradiated, which can result in leukemia and malignancies. Since Americium-241 primarily emits alpha radiation, alpha detection equipment must be used to accurately assess contamination levels. Personal gamma dosimetry is not usually required unless a person is in close contact with the material throughout most of the day.
3. Carbon-14. Carbon-14 is a major research tool. It is used pharmaceutical research, biological research, agriculture, pollution control, and archeology.
4. Cesium-137 emits both gamma and beta particles. It has a physical half-life of 30 years, but is eliminated relatively quickly from the body. The biological half-life is 70 to 140 days. Cesium-137 is found in most tissues of the body, but it will concentrate in muscle tissue. It is absorbed and used the same way as potassium. Meat and milk are the primary sources of cesium. Cesium-137 is also used in medical treatment, gauges, and process control in industry.
5. Cobalt-60. Cobalt-60 emits gamma and beta radiation and has a half-life of 5.26 years. Used to sterilize surgical instruments and to improve the safety and reliability of industrial fuel oil burners. Used in cancer treatment, food irradiation, gauges, and radiography.

6. Iodine-125. Major diagnostic tool used in clinical tests and to diagnose thyroid disorders. Also used in biomedical research
7. Iodine-131 is a beta and gamma emitter and has a short physical half-life of approximately 8 days. It is efficiently absorbed and used by the body. I-131 will contaminate plants that will be eaten by grazing animals. Smaller amounts can also be absorbed by breathing contaminated air. Cattle will excrete a large amount of I-131 in milk. I-131 will be concentrated in the thyroid gland. The intake of I-131 will have its greatest impact the first few days to weeks following a nuclear explosion.
8. Magnesium-thorium alloys. Magnesium-thorium alloys should also be considered as radioactive hazards since radioactive thorium is an alpha emitter. Many aircraft and missile structures contain significant amounts of magnesium-thorium, therefore, in an accident the radioactive thorium must be recovered and disposed as radioactive waste.
9. Nickel-63. With a radiological half-life of 96 years, nickel-63 is a beta emitter with a short decay chain and no gamma radiation. Nickel-63 is found in the chemical agent monitors (CAM). The beta radiation from Nickel-63 will not penetrate the dead layer of skin. Efforts should be taken to prevent ingestion, inhalation, or absorption through broken skin.
10. Plutonium-239. Plutonium-239 is a heavy metal (atomic number 94), which is artificially produced by bombardment of Uranium-238 with neutrons has a 24,000-year half-life. Plutonium-239 is used in nuclear weapons and to power spacecraft.

A. If plutonium particles are inhaled, they will be deposited at all levels of the respiratory system, depending on their size. The larger particles are deposited in the nasopharynx or high in the tracheobronchial tree. Only the very small particles, 5 μm in diameter or smaller, are deposited in the alveolar air sacs. The plutonium deposited in the terminal bronchiolus above the alveolar air sacs will be cleared from the lungs by the action of the ciliated epithelium making up the respiratory mucosa. These particles do not present any significant hazard. The possibility of any significant radiation damage while they are in transit out of the lungs or subsequently during their passage through the gastrointestinal system is almost nonexistent. Any cells that are damaged by radiation would be sloughed off and replaced during the normally high rate of cell turnover that occurs in these tissues.

B. The plutonium remaining in the alveoli can cause damage, since much of it will remain there essentially for the lifetime of the individual. Some of the plutonium particles are phagocytized and picked up by the lymphatic system, but they will not be transported far since a large proportion will be trapped in regional lymph nodes of the lung. Only very negligible quantities will reach the blood stream.

C. Radiation from plutonium and its progeny trapped in the lung tissue can cause an inflammatory response and eventual fibrosis. Carcinogenesis must also be considered a hazard. Most cells damaged by alpha radiation will be lethally damaged. A very small percentage will be non-lethally damaged. However, there is some x-ray and gamma radiation associated with plutonium and its impurities such as Americium-241. The hazard of this radiation to an organ like the lungs is difficult to assess, but it is penetrating and must also be considered as a potential producer of both fibrosis and cancer. This x-ray or gamma radiation has a very low energy level (17 KeV and 60 KeV respectively) and is difficult to detect at low concentrations with standard x-ray sensitive instruments.

11. Radium. Radium is a member of the uranium series. Radium disintegrates with a half-life of 1600 years to form radon, the inert gas that in turn disintegrates into its progenies. Radium is used in gauges and dials in many foreign vehicles.
12. Radon. Radon is a colorless, tasteless, and odorless gas that comes from the uranium decay chain. Levels of radon vary throughout the Earth. Radon usually moves from the ground up and migrates into homes and other buildings through cracks and other holes in their foundations. Buildings trap radon inside, where it accumulates and may become a health hazard if there is no proper ventilation. When one breaths air containing a large amount of radon, the radiation from its progeny can damage the lungs. Several methods are available to accurately measure the presence of radon and its progeny. In a high radon area, it is prudent to determine its level and to take appropriate action if the level is found to be high (for example, greater than 4-8 pCi/liter). Radon measurement techniques can be classified in three categories: 1) grab sampling, 2) continuous active sampling, and 3) integrative sampling. Grab sampling provides instantaneous measures of radon or radon progeny in air. Since values fluctuate widely depending on various factors, grab sampling techniques are used in industrial monitoring. Continuous active sampling involves multiple measurements at closely spaced time intervals over a long period. These are costly and only recommended when other measures indicate a problem and the source of radon entry needs to be pinpointed precisely. Integrative sampling devices are passive, and collect data on radon levels over a fixed period of time [NCRP, 1988 #25].
13. Strontium-89 and Strontium-90 are beta emitters and have half-lives of 51 days and 28 years respectively. These two isotopes are absorbed in the body and used in the same way as calcium. They accumulate in bone, where bone marrow with its blood forming cells is vulnerable. Milk and other dairy products are the primary sources of Strontium-89 and Strontium-90 in the human diet.
14. Thorium. Thorium-232 emits alpha and weak x-rays and betas from its progenies. Thorium can be extracted from mineral monzanite. There is a thorium plating (film) on many optical systems, such as the night vision sights on an M1 tank. The principal use of thorium has been in the preparation of Welsbach mantle, used for portable gaslights. Thorium is used to coat tungsten wire used in electronic equipment because of its high electron emission. Its oxide is also used to control the grain size of tungsten in electric lamps. Another application of thorium is in high-temperature laboratory crucibles. Since glasses containing thorium oxide have a high refractive index and low dispersion, they are used in high quality lenses for cameras and scientific instruments.
15. Tritium (Hydrogen-3). Tritium is an isotope of hydrogen with one proton and two neutrons. The other two isotopes of hydrogen are normal hydrogen (one proton and no neutrons) and deuterium (one proton and one neutron). Deuterium is not radioactive. Tritium is radioactive, emitting a low energy beta particle. Tritium has a physical half-life of 12.26 years.

A. Elemental hydrogen (H_2) is relatively inert; hence, tritium incorporated in molecular hydrogen as HT is relatively inert. The elemental gas is inhaled and exhaled with only about 0.005% of the activity depositing in the lung (Eisenbud 1997). However, when incorporated into water vapor (HTO), tritium distributes through out the body. The uptake of tritiated water vapor is 100%. When exposed to a cloud of HTO, about one third of the uptake will be through skin absorption and the remaining will be inhaled. Generally, tritium will not accumulate in an outside area,

although tritium contamination of metal or other surfaces can be persistent. It would be a hazard if an accident occurred in an enclosed space so that dispersion could not occur.

B. Exposures to very high concentrations of tritium can cause intakes large enough to induce acute radiation symptoms. An accidental exposure leading to a multicurie dose of tritium induced nausea and exhaustion and eventual death of a victim (Conklin 87). Other estimates put the LD 50 at about 10 Ci; this corresponds to about 1 mg of pure tritium. (Sublette 97) This is about the mass of a lethal dose of the nerve agent sarin (Sublette 97).

C. If patients are seen with suspected tritium contamination, the best treatment is to shorten the turnover time of the body water with forced fluid intake and diuretics. This essentially "flushes out" the tritium and can materially reduce the exposure time and the total dose of radiation received. For bioassay, use single void urine sample taken at least four hours post-exposure for suspected personnel exposures.

D. The external radiation hazard from exposure to tritium is extremely small, because the beta particles emitted cannot penetrate the dead layer of skin. However tritium is easily internalized through inhalation and absorption through the skin. The low energy beta radiation from the tritium is an internal hazard only (i.e., the isotope must get inside your body to cause damage).

E. Because of the weak beta radiation, tritium is NOT readily measured by the Geiger-Mueller counter used with most fielded radiac instruments and requires wipe testing swipes and a liquid scintillation detector to determine the level of contamination.

16. Uranium (and Depleted Uranium).

A. Uranium (U) is a heavy metal (atomic number 92) and an alpha emitter. Its progenies emit weak x-rays and betas. Uranium ore is present in most rocks and soils as well as in many rivers and in seawater. Uranium is found in concentrations of about four parts per million in granite, which makes up 60% of the earth's crust. Phosphate rocks, often used as fertilizers, may contain high concentrations of uranium. Uranium is also found in coal and hence in coal ash and other coal plant effluents. Natural fresh waters typically contain in the order of 0.024 to 200 micrograms per liter of uranium. A typical man will contain about 100 –125 micrograms of uranium. The daily uranium intake (largely from food ingestion) and excretion (in feces) in man is about 1 microgram. There are radioactive progenies found with uranium that are potentially a more serious problem.

B. Depleted Uranium (DU). During the enrichment process for nuclear fuel, Uranium-235 is removed from uranium ore. The by-product of this process is *DEPLETED URANIUM* (DU). The US Army and many other nations use DU in armor and munitions. As used by the US Army, DU is typically about 98.8% Uranium-238, 0.2% Uranium-235, and 0.0006% Uranium-234. The external radiation hazard from DU is roughly 40% less than an equal amount of natural uranium.

(1) Because of its high density and structural properties, DU can be applied defensively to protect against penetration by projectiles made of less dense metals, such as tungstoncarbide subprojectiles, or offensively as projectiles to defeat armored targets. The Abrams tank, the Bradley Fighting Vehicle, the Air Force A-10 Thunderbolt "Warthog," and the Marine AV-8B Harrier fire DU munitions. DU ammunition is NOT used for training. Most DU munitions are identified by their black color with white markings on the projectile end. However,

corrosion may alter this color. All peacetime firings are prohibited except on ranges which are approved and licensed by the NRC and/or have host nation agreement.

(2) The newest M1A1 and M1A2 tanks, dubbed "Heavies," have DU packets "molded" into the left and right frontal turret armor. A "U" at the end of the turret serial number identifies tanks with this material.

(3) Depleted uranium munitions were first used in combat during Operation Desert Storm with great success. The British, French, Russian, and Chinese military forces have DU armor piercing projectiles for anti-tank warfare. Also, many other nations are actively pursuing DU munition technology. Therefore, the next time US forces enter battle, DU munitions may be employed by opposing forces.

C. Inhalation. Inhalation of DU is the most significant mode of entry. DU particles can be dispersed in the air by fires involving DU or from DU ammunition impacting armored surfaces. Only very small particles can be inhaled. Of those inhaled particles, some will be soluble in lung fluid and others will not. Those particles that are soluble will be absorbed by the body to become a heavy metal poison (chemically toxic) primarily to the kidneys. The particles in the lungs that are not soluble will remain in the lungs and may be a radiation hazard. The body dispels insoluble particles that remain in the lungs very slowly.

D. Radiation Dose. Once in the body, DU can cause damage by ionizing radiation. The principal radiation hazard from internal deposits of DU is the intense ionization in tissue produced by alpha particles emitted during the radioactive decay process.

E. Chemical Toxicity. Uranium can be toxic to the kidneys. Uranium that makes it into the bloodstream (soluble) damages the very small tubules in the kidney. However, even after exposures to high levels of uranium the kidneys recover. In addition, there is evidence that repeated exposures cause less damage after the first exposure (Conklin 87). The estimated threshold concentration of uranium for kidney damage ranges from less than 1 to 3 microgram per gram of kidney mass (NRC 88). The more soluble components of DU are quickly taken into the blood stream via the lungs or contaminated wounds and may result in significant deposits in the kidney. Once there, some of the DU combines with the protein of cell walls, poisoning the cells and interfering with the vital functions of waste elimination and maintenance of electrolyte balance. The DU does not remain fixed in the kidney, but is eliminated at a rate of about half every two weeks. Moderately severe damage to the kidney as a result of acute exposure is repairable, and a return toward normal kidney function may occur even during continued exposure. For an acute ingestion intake of soluble uranium, the LD₅₀ from kidney damage in man is estimated to be greater than about 1 to 3 milligram per kilogram of body mass (NRC 88). This estimate is very rough because information on humans is scarce. There is usually a lag period of 6 hours to several days followed by chemical necrosis. Even after levels that cause necrosis, the kidneys show evidence of regeneration within 2 to 3 days, depending on the severity of the initial exposure.

F. Treatment. Possible methods to reduce dose from internalized DU are: sodium bicarbonate, chelating drug, or diuretic drug. Oral doses or infusions of sodium bicarbonate are regulated to keep the urine alkaline as determined by frequent pH measurements. Use of diuretic drugs has also been advocated. Both EDTA and DTPA have been used to increase excretion in experimental animals. The effectiveness of both chelating agents is strongly time dependent and

no protective action is observed with a delay of 4 hours or more after exposure. Some of these are IND that require informed consent. Both USACHPPM and AFRRI can provide assistance.

3.25. Delayed Effects and Risk Comparisons

1. Reference: FM 8-9 (Part I).
2. General. Late or delayed effects of radiation occur following a wide range of doses and dose rates. Delayed effects may appear months to years after irradiation and include a wide variety of effects involving almost all tissues or organs. Some of the possible delayed consequences of radiation injury are life shortening, carcinogenesis, cataract formation, chronic radiodermatitis, decreased fertility, and genetic mutations. Irradiation of almost any part of the body increases the probability of cancer. The type formed depends on such factors as area irradiated, radiation dose, age, and species. Irradiation may either increase the absolute incidence of cancer or accelerate the time or onset of cancer appearance, or both.
3. Risk analysis and comparison is very difficult due to the high concern of radiation exposure. It is advisable to contact USACHPPM or other trained Nuclear Medical Science Officers for guidance before making any risk analysis for radiation. The BEIRV committee estimated that the risk of dying of cancer for a low-level exposure to radiation is about 8% per sievert or 0.08% per rem or roughly 10^{-4} per mrem.

Table 3-P: Spectrum of Radiation Limits (Centigray)

Dose	Function	Dose	Function
500	LD 50/60 with supportive care	10	Protection valuable prop; EPA
350	LD 50/60 without supportive care	5.0	Occupational annual limit; 10 CFR
300	Early erythema	5.0	Public organ dose limit; 10 CFR
200	Threshold for cataract	0.5	Average all X-ray procedures; NCRP
150	Emergency risk; STANAG 2083	0.5	Public, annual, infrequent; NCRP
100	Urgent action, accident; ICRP 63	0.30	Naturally occurring annual dose, US; NCRP
70	Moderate risk; STANAG 2083	0.10	Public, annual, continuous exposure; NCRP
50	Negligible risk; STANAG 2083	0.10	Public; 10 CFR
50	Emergency limit; ICRP	0.015	Annual Public limit for decontamination; EPA
25	Life saving; EPA	0.001	Insignificant dose; NCRP

4 BIOLOGICAL

Table of Contents

4.1.	Intelligence _____	4-2
4.2.	Operational Issues _____	4-8
4.3.	Technical _____	4-15
4.4.	Biological Agent Operational Data Charts _____	4-20
4.5.	Medical _____	4-27
4.6.	Detailed Description of Some Biological Agents _____	4-31

List of Tables

Table 4-A:	Determining Vulnerability to BW Attack _____	4-4
Table 4-B:	Duration of Impact of Possible Biological Weapons Agents _____	4-7
Table 4-C:	Threat Potential of BW Agents to Drinking Water _____	4-7
Table 4-D:	Supply Increase during a BW Attack _____	4-11
Table 4-E:	BW Agents, Scientific Names or Toxin Source and Type _____	4-20
Table 4-F:	Bacteria Operational Data _____	4-22
Table 4-G:	Rickettsiae, Chlamydia and Fungal Operational Data _____	4-23
Table 4-H:	Toxins Operational Data _____	4-24
Table 4-I:	Viruses Operational Data _____	4-25
Table 4-J:	Types and Characteristics of Some Biological Agents _____	4-28
Table 4-K:	Potential BW Agents by Predominant Clinical Finding or Syndrome _____	4-29
Table 4-L:	Differentiation Among Botulinum, Nerve Agent, and Atropine _____	4-30
Table 4-M:	Infective Dose and Diagnostic Sample Assays of Biological Agents _____	4-30

List of Figures

Figure 4-A:	BW Risk Assessment _____	4-3
Figure 4-B:	Distribution of Droplets into the Respiratory System _____	4-8

4.1. Intelligence

1. References: FM 3-3, FM 3-4, FM 3-6, FM 3-7, FM 3-3, FM 8-9, FM 8-10-7, JP 3-11 (Draft), TC 3-10, and USAMRIID's *Medical Management of Biological Casualties*.
2. General. The Armed Forces Medical Intelligence Command (AFMIC) is a useful source to obtain information on expected disease occurrences in a geographical area in order to differentiate natural disease epidemics from biological warfare (BW) attacks. They can also assist in the theater threat assessment by evaluating the state of a potential adversary's BW effort. Tactical medical intelligence units conduct investigations of disease resulting from suspected enemy biological agent employment and can provide limited analysis of enemy drugs, serums, and antibiotics. Estimating the risk of a BW attack and determining unit vulnerability should be determined. The importance of medical alertness cannot be overemphasized. BW risk assessment may be determined using Figure 4-A and the vulnerability to BW attack can be determined using Table 4-A.
3. Recognition of Biological Attack.
 - A. General. It is very difficult to detect a biological weapons attack before illnesses occur as there are few detection kits or systems which are capable of warning commanders prior to the actual attack. The Biological Integrated Detection System (BIDS) has been recently deployed and could be used to detect a biological warfare (BW) attack. A regimen of vaccines and good intelligence will also greatly assist in the defense against biological warfare.
 - B. Medical Surveillance. A BW attack will most likely be completed before a local commander will be aware that it has taken place. Consequently, when signs of illness occur which lead one to suspect a BW attack, the first task of the medical officer is to attempt to distinguish between a possible BW attack and a disease outbreak of natural origin. The medical officer is responsible for conducting an epidemiological survey to determine the origin of a disease outbreak (i.e. a BW attack or natural occurrence). This survey will take into account such factors as:
 - (1) disease incidence (number who have the disease)
 - (2) expected disease incidence for the area of operations (a BW attack would result in a higher than normal expected incidence)
 - (3) sudden appearance of a disease which is unusual for the area of operation
 - (4) determination of the source of the disease (e.g. aerosol pattern, food-borne illness, water-borne illness, geographic pattern).
 - C. Medical Indications. Sick individuals may be the only initial indication that a BW attack has occurred. Most early symptoms from a BW attack will be similar to the flu. However, an unusual number of cases of skin rash, jaundice, diarrhea, sore throat, pneumonia, mental abnormalities, or hemorrhaging may also be encountered. Naturally occurring disease and illnesses from a BW attack may occur simultaneously, which further complicates recognition of an attack. Further confusion may result when multiple BW agents are used simultaneously, or chemical and biological agents are combined in a single attack. Medical officers must maintain routine disease surveillance as rapid detection and definitive identification of suspected BW agents are essential for tactical and political as well as medical purposes.

Figure 4-A: BW Risk Assessment

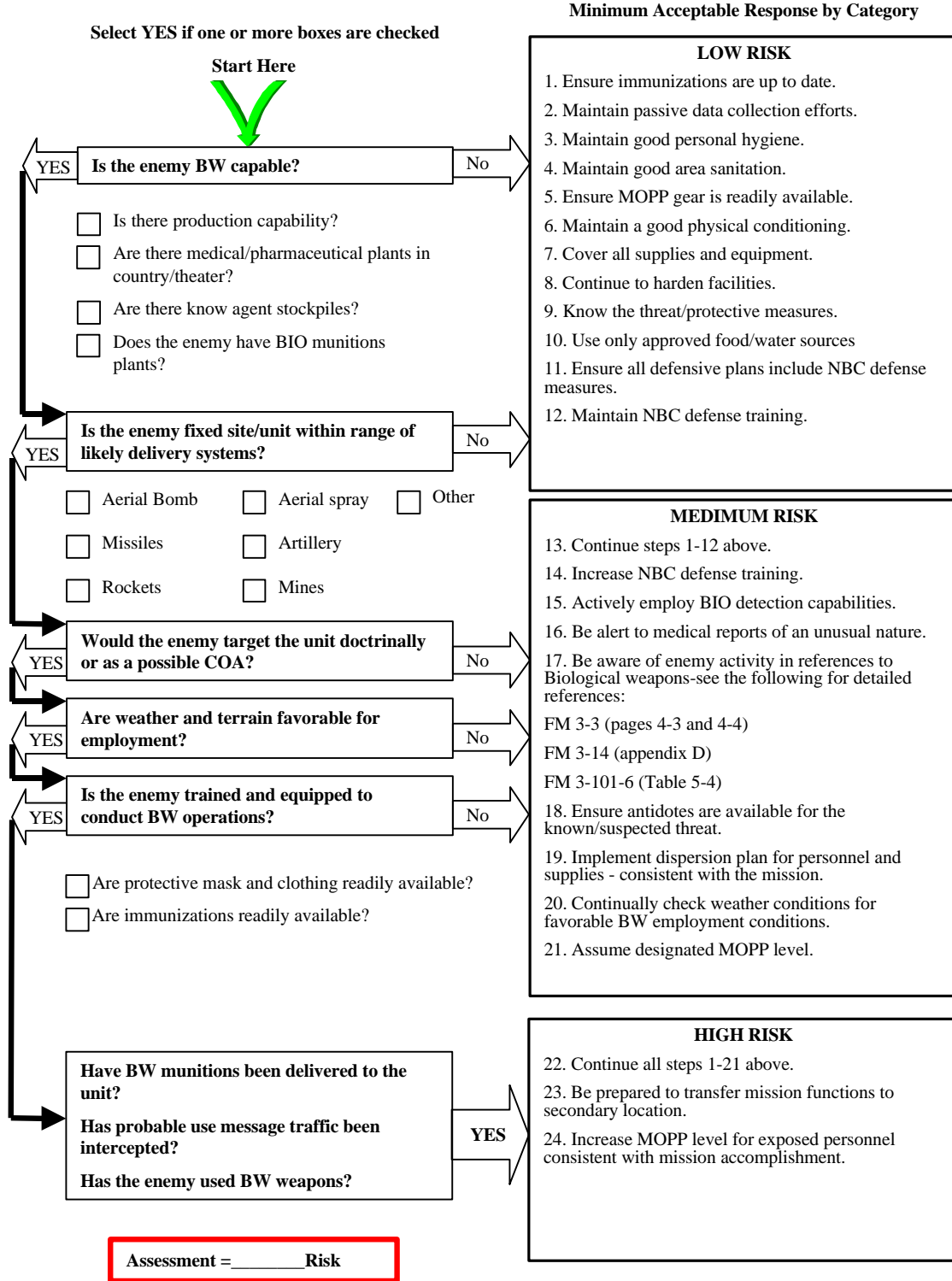

Reference: Figure I-6 from Joint Pub 3-11 (Draft)

Table 4-A: Determining Vulnerability to BW Attack

Begin at the left column and successively add the values from each following column.

PERCENT OF TROOPS IMMUNIZED AGAINST PREDICTED AGENTS		PROTECTIVE POSTURE		DETECTION POSTURE		HYGIENE		DISPOSITION	
Relative Value		Relative Value		Relative Value		Relative Value		Relative Value	
Complete ≥ 90%	2	MOPP 3/4	2	BIDS LRBSDS IBADS	2	GOOD	1	MOBILE	1
Incomplete <90%	4	*MOPP 1/2 Mask Only	4	Less than two of these symptoms	4	AVG	2	SEMI- MOBILE	2
NONE	6	MOPP Ready/ MOPP ZERO	6	NONE	6	POOR	3	STATIC	3
Relative Values = Subjective Rating					Minimum actions resulting from these ratings are described below.				
8-9		LOW							
10-16		MEDIUM							
17-24		HIGH							
LOW:		<ul style="list-style-type: none"> Maintain current efforts. Attempt to improve on those areas that are weak. 							
MEDIUM:		<ul style="list-style-type: none"> Analyze current actions and increase efforts to reduce rating- concentrate on those areas that you have immediate control over (e/g/.MOPP levels & hygiene and possibly detection assets). 							
HIGH:		<ul style="list-style-type: none"> Analyze current actions and immediately increase efforts to reduce rating- concentrate on those areas that you have immediate control over (e.g., MOPP levels and hygiene). If you do not have operational control of detection assets, determine where these assets are and if you are inside the detection “umbrella” or if these assets can be repositioned to cover your operation. Determine if immunization rates are satisfactory for the total force. Typically contract workers will require more immunizations than US military personnel. Provide immunizations as soon as medical and political situations allow. Remember that immunizations require time to work effectively. 							
*If “masks only” protective posture provides required protection for predicted agent, use a value of 2.									

Reference: Table I-1 from JP 3-11 (Draft).

D. Characteristics of a BW Attack.

(1) Unusual Number of Casualties: An unexpected large number of casualties may occur during a short period of time. A large number of casualties within 48-72 hours suggests an attack with a microorganism. If the casualties occur within minutes to hours, a toxin is more likely. A large number of clinical cases relative to the number of exposed individuals; or other epidemiological evidence of a massive single source disease outbreak may all be indicative of a BW attack.

(2) Unusual Distribution of Casualties: Both military and civilian casualties can occur, or only military casualties if a military specific target is used (e.g. military food or water supplies). A high number of respiratory cases, or casualty distribution aligned with wind direction, might be indicative of an aerosol attack. Lower attack rates among those working indoors, especially in areas with filtered air or closed ventilation systems, may also be evidence of a BW attack.

(3) Unusual Geographic Distribution: Certain biological agents, like toxins, can be used most effectively on smaller targets, while others can be disseminated more efficiently over extremely large areas (for example, anthrax). Large numbers of rapidly fatal cases, with few recognizable signs and symptoms, may indicate exposure to multiple lethal doses from a single source.

(4) Unusual Disease Pattern. The disease pattern is likely to differ from those of a naturally occurring epidemic. For example, except for food borne outbreaks, disease incidence in naturally occurring epidemics usually increases over a period of weeks or months. However, in a BW attack, the increase in disease incidence may be only hours or days. Furthermore, instead of the usual peaks and troughs evident in most natural outbreaks, a steady and increasing stream of patients will be seen in a BW attack, similar to a food poisoning outbreak.

(5) Unusual Disease Outbreak: The occurrence of a vector-borne disease without the vector (e.g. mosquito or tick) or the occurrence of a disease that is highly unusual for the geographic area. An example would be a disease outbreak of Venezuelan equine encephalitis in Europe where it does not naturally occur or such an outbreak during the winter (the disease requires a mosquito for transmission in a natural outbreak). Emergence of an atypical pattern mandates notification of higher authority.

(6) Unusual Disease Symptom: For example, an unusually high prevalence of respiratory disease (e.g. pneumonia) from a disease that more often occurs naturally as a skin disease (e.g. inhalation versus cutaneous anthrax; pneumonic versus bubonic plague).

(7) Illness in Animals and Humans: An increased number of sick or dead animals, often of different species (e.g. horses, cows, dogs) at the same time as an increased number of human illnesses. (Most BW agents are capable of infecting/intoxicating a wide range of hosts.)

(8) Evidence of an Attack: Although rare, a witness to an attack, or the discovery of an appropriate delivery system may be further evidence of a BW attack.

(9) "Own-Goals" and "Hang-Fires": A number of initial BW attacks may be expected to fail in this manner so one should look for unusual disease events in the opposition. An *Own-Goal* will result in unexpected and unusual deaths thanks to a device going off too soon. For example, a terrorist's bomb going off in houses while being constructed or in cars on the way to the target.

A *Hang-Fire* would be evidenced by excessive preventive action without obvious cause until intelligence is available, as the opponents have to defuse and decontaminate equipment.

4. Dissemination of Biological Agents.

A. General. Dissemination is the process by which infectious diseases or toxins are dispersed to cause disease or intoxication. The same routes of entry pertinent to natural spread of diseases (inhalation, ingestion, or percutaneous inoculation) are also relevant when their agents are delivered intentionally by weapons. BW agents are likely to be delivered covertly either by contamination of food and water, or by aerosol exposure. The type of delivery will affect the type of dissemination.

B. Aerosol. Delivery by aerosol is considered to be the most important route of attack. Infectious disease organisms are subject to decay over time, which will vary with environmental factors and the nature of the organism. Thus, atmospheric conditions are critical to the effective use of biological agents distributed by aerosol exposure. In general, the optimal time for use of aerosol BW weapons is during the late night and early morning when inactivation of biological aerosols by ultra-violet radiation is minimal. In addition, neutral or inversion conditions are most likely to be present at these times which best allows an agent cloud to travel along the land surface. Inhalation of agents (respiratory exposure) results in deposition of infectious or toxic particles within the lungs which may provide a further direct pathway to the systemic circulatory system depending on the size of the droplet (see Figure 4-B). Droplets as large as 20 microns can infect the upper respiratory tract. However, these relatively large particles are filtered by natural processes and are too large to reach the systemic circulation. Access to the circulatory system requires particles ranging from 0.5-5 microns in diameter. Aerosol delivery systems aim to generate invisible clouds with particles or droplets between 0.5 and 10 microns that can remain suspended for long periods. Smaller sized particles are not efficiently retained by the human respiratory tract and are relatively unstable under environmental conditions. Infection by the respiratory route may induce disease at doses lower than those generally associated with naturally acquired infections by the oral route. The subsequent illness may differ from the natural pattern, and the incubation period may be much shorter.

C. Dermal Exposure (Percutaneous). Intact skin provides an excellent barrier for most, but not all, biological agents. However, mucous membranes and damaged skin constitute breaches in this normal barrier through which agents may readily pass. Agents passing through the skin may cause skin lesions, or more rarely, can enter the systemic circulation to cause more generalized disease anywhere in the body. Generally, disease symptoms from skin exposure take longer to occur than those from aerosol exposure (3 to 10 days versus 1 to 3 days).

D. Alimentary Exposure (Ingestion). Direct contamination of consumables, such as drinking water, foodstuffs, or medications, could be used as a means to disseminate infectious agents or toxins. This method of attack would be most suitable for sabotage activities and might be used against limited targets such as water supplies or food supplies of a military unit or base. Filtration and adequate chlorination significantly reduce this hazard as it pertains to water. However, survivability of the infectious agent or toxin in water is highly variable (see Table 4-C).

E. Vector-Borne Attacks: Large number of infected live vectors can be produced to spread vector-borne diseases by releasing infected arthropod hosts such as mosquitoes, ticks or fleas.

F. Agent Survival: There is potential for delayed generation of secondary aerosols from previously contaminated surfaces. To a lesser extent, particles may adhere to individuals (skin or clothing) creating additional, but less significant, exposure hazards.

G. Person-to-person spread: Humans, as unaware and highly effective carriers of a communicable agent, could readily become a source of dissemination of certain agents by direct contact (skin or clothing) or aerosol droplet spread (e.g. sneezing or coughing).

Table 4-B: Duration of Impact of Possible Biological Weapons Agents

Biological Agent	Duration of Impact
Bacterial (e.g., anthrax)	12 hours - 21 days
Rickettsial (e.g., Q fever)	3 - 21 days
Viral (e.g., Rift Valley fever)	3 - 24 days
Fungal (e.g., histoplasmosis)	5 - 21 days
Toxins (e.g., botulinum)	< 36 hours

Reference: Table 1-3 from TC 3-10.

Table 4-C: Threat Potential of BW Agents to Drinking Water

Agent	Water Threat	Stable in Water	Chlorine Tolerance
Anthrax	Yes	2 years (spores)	Spores resistant
Brucellosis	Probable	20-72 days	Unknown
<i>Clostridium perfringens</i>	Probable	Common in Sewage	Resistant
Tularemia	Yes	up to 90 days	Inactivated 1 ppm- 5 min
Glanders	Unlikely	up to 30 days	Unknown
Melioidosis	Unlikely	Unknown	Unknown
Shigellosis	Yes	2-3 days	Inactivated 0.05 ppm- 10 min
Cholera	Yes	Survives well	Easily killed
Salmonella	Yes	8 days, fresh water	Inactivated
Plague	Yes	16 days	Unknown
Q fever	Possible	Unknown	Unknown
Typhus	Unlikely	Unknown	Unknown
Psittacosis	Possible	18-24 hrs, seawater	Unknown
Encephalomyelitis	Unlikely	Unknown	Unknown
Hemorrhagic fever	Unlikely	Unknown	Unknown
Variola	Possible	Unknown	Unknown
Hepatitis A	Yes	Unknown	Inactivated 0.4 ppm-30 min
Cryptosporidiosis	Yes	Stable days or more	Oocysts resistant
Botulinum toxins	Yes	Stable	Inactivated 0.6 ppm- 20 min
T-2 mycotoxin	Yes	Stable	Resistant
Aflatoxin	Yes	Probably stable	Probably tolerant
Ricin	Yes	Unknown	Resistant at 10 ppm
Staph. Enterotoxins	Yes	Probably stable	Unknown
Microcystins	Yes	Probably stable	Resistant at 100 ppm
Anatoxin A	Probable	Inactivated in days	Unknown
Tetrodotoxin	Yes	Unknown	Inactivated 0.5 ppm
Saxitoxin	Yes	Stable	Resistant at 10 ppm

* Ambient temperature, 1 ppm FAC, 30 minutes, or as indicated

Reference: Medical Issues Information Paper No. IP-31-017, "Biological Warfare Agents as Potable Water Threats". USACHPPM.

Figure 4-B: Distribution of Droplets into the Respiratory System

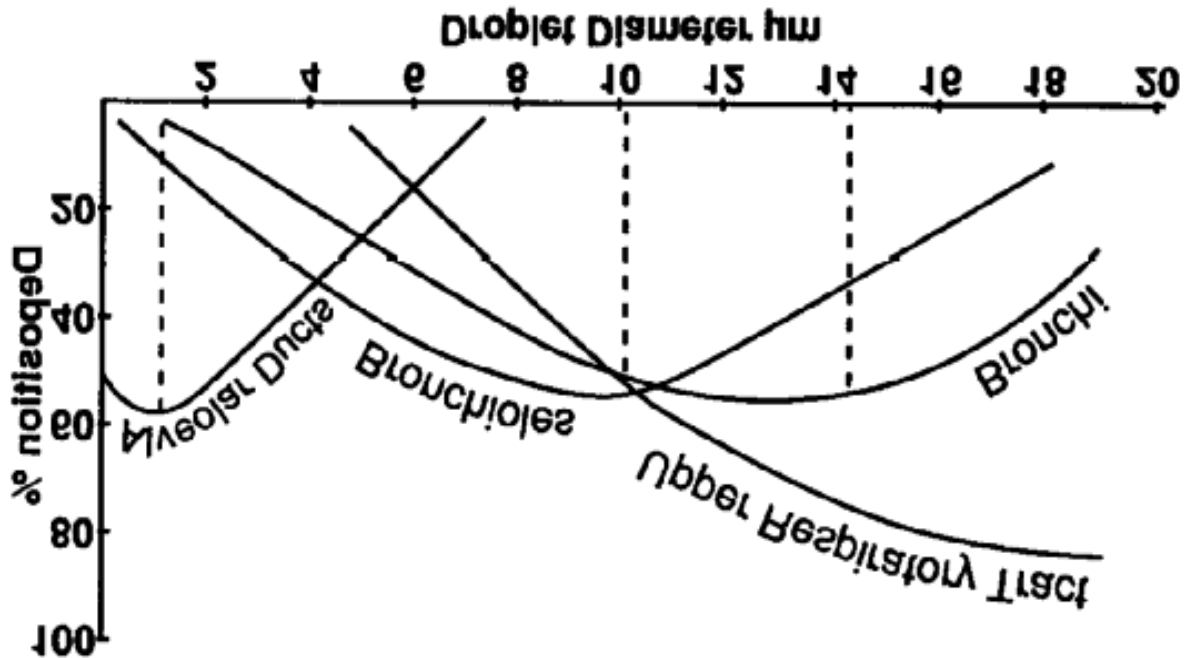

Reference: Figure 1-I from FM 8-9 (Part II).

4.2. Operational Issues

1. References: FM 3-3, FM 3-4, FM 3-5, FM 3-6, FM 3-7, JP 3-11 (Draft), FM 8-9, FM 8-10-7, USAMRIID's *Medical Management of Biological Casualties*., and USAMRMC's *Medical Products for Supporting Military Readiness, Vaccines & Drugs (GO BOOK)*.
2. Biological Hazard Plotting and NBC Reports.
 - A. General. Downwind hazard prediction for biological agents is very similar to procedures for chemical agents. The resulting prediction provides a general, minimal estimate of danger zones before actual agent has been identified, and before sampling is done to further identify areas affected.
 - B. Warning Reports. The NBC Center (NBCC) will issue an NBC 3 chemical / biological report to alert units in the immediate downwind hazard area. Each unit evaluates the report and distributes it to subordinate units that might be affected. This warning will be adequate for the first 1-5 hours (depending on wind speed), and will relate to about half of Zone I of a simplified biological hazard prediction. (Zone I is the area for which more than 20-30% casualties are predicted. Casualty prediction in Zone II is 20-30%, decreasing to 2-3%.) Units in Zones I and II should receive NBCC biological reports for adequate warning. For a discussion of the NBC Warning and Reporting System, see FM 3-3, Chapter 2.
 - C. Hazard Prediction. All attacks in daytime and all toxin attacks are presumed to have a period of 8 hours in which the agent cloud retains its effectiveness. For nighttime attacks, the cloud effectiveness may be longer, and should be calculated by NBCC. Further effects of time and weather conditions on the persistence of biological agents are discussed in FM 8-9, FM 3-3, Chap. 4, and FM 3-6, Appendix B, (Draft, 1997).

D. The Maximum Downwind Hazard (MDWHD) for a biological attack may be calculated by multiplying the windspeed (in km per hr) times four, times the duration of effective agent cloud. For example, for a windspeed of 5 km/ hr, and an effective cloud duration of 8 hours, the MDWHD = 4 X 5 X 8 = 160 km. Hazard area predictions become less reliable as distance and time from the point of attack increase.

3. Biological Contamination of Food and Water. Toxins and microorganisms will probably be the primary form of contamination of food and water. It is unlikely that a biological agent will materially affect the appearance, taste or smell enough for the change to be apparent. The normal packaging and packing of food provides protection against most biological agents. Decontamination procedures are only necessary for spore-forming agents such as anthrax. If the agent is unknown, decontamination is advised. Operational rations are packaged in metal containers or aluminum laminated plastics that can withstand boiling and are resistant to arthropod penetration, thus making them highly resistant to biological agents. Food stored in freezers, refrigerators, and in refrigerated trucks or rail cars will be safe if the containers remain sealed until the outer surfaces are decontaminated. The use of unpackaged items should be restricted. Use only operational rations. Unprotected food in the open and close to the source will become contaminated. The inspection and monitoring of food and water is absolutely essential for rapid identification. Samples of suspect food must be sent to the supporting laboratory (in theater) and will be confirmed by CONUS laboratory evaluation. No field expedient method exists for the identification of food suspected of being contaminated with a biological agent.

4. Medical Support Considerations.

- A. General.

- (1) The medical management of casualties resulting from the use of BW agents is a problem of managing large numbers of individuals with infectious disease or exposure to toxins. Medical units will require augmentation to decontaminate incoming casualties. The fact that the source of the exposure may have been artificially created by deliberate, hostile means will not change the basic principles of treatment. For instance, in the event of a biological attack, the most important factor in providing operationally relevant information and adequate medical management will be the rapid establishment of an accurate, specific identification of the agent. In contrast to naturally occurring epidemics in which the disease incidence increases over a period of weeks or months, an artificially induced epidemic will peak in a few hours or days. Since a biological attack may be silent or nearly so, the first indication of a problem may well be the appearance of a wave of casualties in which medical personnel are unable to differentiate natural disease epidemics from covert enemy attacks. Onset of illness following exposure to toxic agents may range from minutes to as long as 3 weeks. Some potential BW agents are transmissible among humans, so spread after the initial attack may become an important planning consideration. An increasing casualty load is anticipated with relatively few initial casualties and a greater number over successive hours or days until a peak is reached. An exception to this aspect would be an attack with a biological toxin that might create an immediate and dramatic mass casualty situation.

- (2) The large number of casualties resulting from the use of BW weapons and the special handling required can drain medical resources. Therefore, the combatant commander must plan to use directive authority to ensure the proper coordination of health service to the force, to include adequate shelter, food, medical prophylaxis, and fluids.

(3) Decontamination and collective protections for BW attacks are particularly important if the situation necessitated a prolonged stay in a presumptively contaminated area. Medical management must provide reasonably adequate shelter, establish uncontaminated food and water intake, and ensure specific treatment is available. Demands for military medical support to neighboring civilian populations following such an attack will probably be intense, especially if the attack contaminated neighboring civilian populations with concentrations of very young, very old, and those already suffering from underlying disease or other forms of weakening stress. Medical facilities security must also be planned.

B. Preventive Medicine Principles.

(1) In a BW environment, preventive medicine (PM) services will be in great demand. PM personnel must assist the commander in determining the health hazards associated with BW contamination, such as safe food and water sources, and in determining when to use prophylaxis, immunization, and other preventive measures associated with BW warfare. The tendency of individuals in an emergency situation to become careless regarding food and water sanitation, general hygiene, and other common disease control measures could be a significant cause of secondary spread of disease. The problems of maintaining safer water and food conditions will differ for military personnel deployed throughout the operations area and for the civilian.

(2) Following a food-related BW attack, all food except canned or otherwise well-protected food should be thoroughly inspected to ensure adequate protection was provided. Foods determined to be safe must be protected against secondary contamination. Protective measures must be practiced by those who transport, store, prepare, and serve food, as well as by those who consume the food. In addition, consideration must be given to the application of control measures necessary to prevent contamination of consumables by insects, rodents, and other vectors. It is difficult to maintain satisfactory personal and area field sanitation, particularly in unfamiliar climates. Strict measures are required for waste treatment and sewage. Water surveillance and area water sanitation control measures must be instituted. The best insurance of water sanitation is water purification or boiling. However, water purification tablets and military systems for boiling or purifying large amounts of water for consumption and hygiene purposes are NOT EFFECTIVE against certain BW agents. For further information on purification of water contaminated with biological agents, see Medical Issues Information Paper No. IP-31-017, "Biological Warfare Agents as Potable Water Threats" USACHPPM, 1998.

C. Impact on Medical Facilities. BW agents are capable of producing mass casualties. In the first few hours after a BW attack, medical facilities can be swamped with casualties who may require lengthy hospitalization. At the same time the patient load is increasing, the factors combine to complicate Health Service Support (HSS) operations. Operations in MOPP gear reduce individual and collective efficiency at a time when manpower requirements increase. Patient decontamination requires manpower, and will reduce the number of personnel available to treat casualties. Heat stress in MOPP will require more frequent rest breaks, further reducing care capability. Establishing and maintaining a facility with collective protection support and continuously monitoring the air inside the shelter for contaminants calls for additional personnel. These procedures decrease the ability to treat patients as efficiently and effectively.

D. Impact on HSS. Immediately obtaining very large amounts of the appropriate treatment (if any) is critical. This requires informing the chain of command before absolute confirmation of a BW attack can be made. The number of soldiers believing they are ill will likely be much larger than those

actually exposed. Commanders, soldiers, host nation leaders and populations and national leaders will immediately ask for more information than will be available.

E. Oxygen production and resupply. Production of liquid and gaseous oxygen normally will not occur in an NBC contaminated environment. Although newer production plants have been designed for potential operation in such a state, generally production will be stopped until air quality improves. Product transfer operations (gaseous and liquid) will also be curtailed unless medical and flight line requirements demand such. Supply and medical units must develop plans to resupply critical gases and cryogenic liquids in the contaminated area from primary and alternate sources. These sources include production and storage capabilities organic to the unit from other services, from host nation support, and from commercial contracts.

F. Special Medical Augmentation for Operations in an NBC Contaminated Environment. Decontamination operations are extremely resource intensive. It is unrealistic to expect that medical personnel will be able to manage both medical treatment and decontamination of patients. For this reason, plans must address how decontamination will be accomplished. Augmentation to provide decontamination support must also be addressed in planning.

5. Medical Planning Specific to Biologically Contaminated Areas.

A. General. Actions to be taken by field units at the platoon, company, and battalion levels are given, in the form of checklists, for a number of possible BW scenarios in FM 3-3, Appendix B. See also Figure 4-A and Table 4-A in this chapter.

B. Logistics Planning: A BW attack would result in an increased use in the supplies (Table 4-D).

Table 4-D: Supply Increase during a BW Attack

Laboratory Supplies (e.g. sample collection containers, diagnostic test, shipping supplies)	Sample Transport Assets (boxes, ice, vehicles, personnel)
NBC respirator, suits, gloves, and boots	Casualty wraps for patients (to protect against exposure)
Filter blower units to provide overpressure protection	Air filters to seal off building air entrance mechanisms
Decontamination Supplies (e.g. water, extra clothing, disinfectants)	General Medical Supplies (e.g. IV fluids & supplies)
A 100mile/hr≅ tape for sealing windows/doors	Collective protection units with airlocks
Rodent control supplies (check with PM units)	Field sanitation supplies (check with PM units)
Vaccines	Antibiotics
Liquid and Gaseous Oxygen	Evacuation Assets
Patient Respirators	Water
Extra Personnel	

C. Individual Protection. The NBC respirator, suit, and gloves will provide protection against most biological agent attacks delivered by the aerosol route. Currently, fielded respirators equipped with standard NBC filter canisters will protect the respiratory system against particles greater than 1-1.5 micron in size. While the MOPP suits employed against chemical agents will also protect against biological agents, even standard uniform clothing of good quality affords reasonable protection against dermal exposure to biological agents. Casualties unable to wear MOPP should be in casualty

wraps designed to protect the patient against chemical or biological agent exposure. The addition of a filter blower unit, if available, provides air overpressure to enhance protection and cooling. Individual Protective Equipment is discussed more fully in FM 3-4. Most BW agents are only inhalation, water, or a food hazard. While the BW agent may not contaminate the environment, the potential for repeated attacks may require maintaining an increased protective posture. It is important that overprotection (MOPP 4) not be maintained longer than necessary. Overprotection will greatly reduce operational effectiveness.

D. Collective Protection. A dedicated hardened or unhardened shelter, equipped with an air filtration unit providing overpressure, can offer collective protection for personnel in biologically contaminated environments. An airlock to the unit ensures that no contamination will be brought into the shelter.

Casualties and contaminated personnel must be decontaminated prior to entering the unit. In the absence of a dedicated structure, enhanced protection can be afforded within most buildings by sealing cracks and entry ports, and providing air filtration within existing ventilation systems. Due to the requirement to continue operations in a contaminated environment, most medical treatment will likely take place in a collective protection unit. These units provide the most effective method for protecting patients and ensuring continued medical capability in a contaminated environment. Patients whose illness is thought to be the result of a biological attack, or those who are thought to have a contagious infectious disease, will necessarily be cared for using barrier nursing techniques while inside a collective protection system. Collective protective systems are further discussed in FM 3-4, Chapter 6.

E. Sanitation. The importance of effective hygiene and sanitation in a biological operations environment cannot be over-emphasized. Everyone is responsible to ensure that standards of hygiene are maintained even in the most difficult circumstances. Personal hygiene measures such as: frequent and adequate washing with soap and water, regular changes with laundered clothing, use of liberally disinfected toilets and field latrines (as opposed to cat-scratch methods), and hand-washing after latrine use should be mandatory and emphasized by commanders. Since mechanical means or natural vectors may spread biological agents, effective control of rodents and arthropods is also a sanitation priority.

F. Immunoprophylaxis.

(1) Prophylactic immunization is the only means of providing continuous protection against BW threats prior to, as well as during, a BW attack. Vaccines against a number of potential BW agents are available. However a series of vaccine doses, often over the course of months, is usually needed to provide protection. Furthermore, commanders must be careful that vaccination status does not provide a false level of security. Vaccines, which generally are considered effective under natural circumstances, may not provide a similar degree of protection to individuals exposed to biological aerosols due to the large number of infectious or toxic particles and unnatural means of exposure.

(2) GO BOOK. The GO BOOK provides a summary of vaccines and drugs that are available from the U.S. Army Medical Research and Materiel Command (USAMRMC) to support operational readiness by protecting U.S. forces against infectious disease, biological, or chemical warfare threats. This represents the first such published listing of licensed products, as well as materiel potentially available under contingency protocols. While not a comprehensive reference to all medical products available in the supply system, the document references selected materiel managed by the USAMRMC to support the military as it prepares for contingencies. It is named

the "Go Book" as it provides information to facilitate planning by the CINCs' and other military staffs as they prepare to go to war. This document is therefore a planning guide, not a guide to the clinical use of the products listed. The web site is <http://206.156.10.15/gobook/gobook.html>.

G. Chemoprophylaxis. Use of broad-spectrum antibiotics may offer protection against some BW agents. For some biological agents, administration of antibiotics following exposure, but prior to appearance of symptoms, may be lifesaving. If an attack has occurred or is imminent, directed chemoprophylaxis would be appropriate for all personnel in the attack area. Knowledge of incubation periods, disease pathogenesis, type of BW agents, and expected effectiveness of prophylactic drugs must be considered in the rationale and timing for dose and schedule of drug administration.

6. Decontamination and Other Considerations.

A. General. Medical Treatment Facilities (MTFs) will establish decontamination areas. When casualties arrive at the MTF, they must be seen at a triage point and evacuated to the proper area. The triage officer must determine if the patients have a surgical or medical condition that requires priority over decontamination. Ninety to ninety-five percent of all decontamination can be accomplished by removing the outer clothing and shoes. This can usually be accomplished before admission without interfering with medical treatment. Several unique aspects must be considered.

B. Primary Exposure to BW Agent. Washing with soap and water is the most effective personal hygiene measure for the control of communicable diseases. It is the responsibility of each person to apply standard individual protective and sanitary measures as appropriate. Dermal exposure from a suspected BW attack should be managed by decontamination with copious quantities of 0.5% hypochlorite (if available) or soap and water at the earliest opportunity. Use water only if soap is not available. Use the NBC protective mask, avoid contact with mucous membranes (i.e. eyes, mouth, nose, genitals) or open cuts, shower, and change to clean clothing at the earliest opportunity. Potentially contaminated clothing should be removed as soon as is practical by protected personnel in an area away from non-contaminated patients. Casualty decontamination procedures are first performed by individual soldiers, as buddy aid, or at a unit decontamination station, prior to arrival of medical personnel or transport to a MTF. Decontamination for BW agents is similar to that for chemical agents. See FM 3-5 for procedures for individual buddy aid and unit decontamination. Decontaminate toxins using soap and water, bleach, M258 series kits, STB, or DS 2. The M258 A1 kit is being replaced by the newer M291 kit.

C. Secondary Exposure to BW Agent. Secondary contamination of medical personnel from clothing or equipment of exposed soldiers is not likely, but may occur. Therefore, biological casualties should undergo a modified decontamination. Proper physical protection of health care providers or other persons handling exposed casualties should be maintained until decontamination is complete. In the absence of agent-specific guidance, exposed areas of personnel should be cleansed using an appropriately diluted sodium hypochlorite solution (0.5%) or copious quantities of plain soap and water. This should follow any needed use of decontaminants for chemical agents but should be prompt. Chlorine can be used in two concentrations: 5.0% and 0.5% (1/2%). However the stronger solution is for gloves and equipment items; it is not to be used on skin, masks, splints, or to irrigate wounds.

D. Transportation Decontamination. There are three basic modes of evacuating casualties (personnel, ground vehicles, and aircraft) in the combat zone. Actions should be taken immediately to ensure all personnel suspected of being contaminated by a BW agent are cleaned and kept free of

disease-producing organisms. A BW environment forces the commander to consider to what extent he/she will commit evacuation assets to the contaminated area. If a task force is operating in a contaminated area, most of the medical evacuation assets will be operational. Similar to chemical exposure, casualties and other exposed personnel should be decontaminated before entering an uncontaminated transport vehicle, or the vehicle should be considered contaminated. Only personnel in full protective posture should operate a contaminated vehicle, and casualties will have to be transported to a decontamination station for decontamination prior to entering uncontaminated conveyances or treatment units. Every effort should be made to limit the number of evacuation assets that are contaminated. To ensure contamination of evacuation assets is limited, patients should be decontaminated before transport. Forward evacuation within the combat zone is normally the responsibility of the respective component command using organic service-assigned assets. AF fixed wing aircraft with specialized aeromedical evacuation crews can assist with forward evacuation if the terrain, distance, and other related factors are not conducive to using organic assets. Movement of patients within the theater is the responsibility of the geographic combatant commander. The CINC, US Transportation Command is responsible for establishing, operating, training, and maintaining the common-use aeromedical evacuation system for movement between theaters and from theater to the continental US.

E. Patient Decontamination and Triage. The management and treatment of contaminated casualties will vary with the tactical situation and the nature of the contaminant. Each medical unit must have a plan that can be put into effect immediately. Decentralization is necessary - casualties must not be forced to wait at a central point for decontamination. All medical units should have comparable sets of medical items and decontamination equipment for treatment of contaminated patients originating in their area. Decontamination of patients serves two purposes: it prevents the patients from absorbing additional contaminants, and it protects medical personnel treating the patient and other patients from contamination.

F. Protection of Health Care Personnel. Following decontamination, patients are cared for using standard nursing management techniques including universal infectious disease precautions (i.e. use of impermeable surgical gowns/oral-nasal masks/face shields or goggles/surgical gloves and observance of universal (body fluid) precautions/barrier nursing techniques). Significant risk for person-to-person spread may exist for individuals not directly involved in patient care. In particular, materials soiled by any fluids from contaminated patients, as well as samples for diagnostic laboratory study, must be clearly identified as hazardous and handled appropriately. Similarly, invasive medical and surgical procedures pose potential risks. It must be emphasized, however, that not all biological agents pose a hazard for secondary transmission. Rapid identification of the BW agent will elicit further guidance from medical officers as to more specific means of decontamination and protection.

G. Handling of Contaminated Remains. Persons handling biologically contaminated remains should be in full protective posture (unless otherwise modified by medical personnel) and cognizant of the potential secondary contamination hazards. Contaminated remains must be interred in accordance with appropriate Joint Service and NATO doctrine and procedures. (See JP 3-11).

7. Mass Casualty Management for BW.

A. The medical equipment needed for treatment of BW patients depends on the specific agent. Unlike a typical mass casualty situation, few BW patients will require surgery. Biological toxins,

where dramatic, acute signs such as respiratory paralysis necessitate various types of advanced equipment (for instance, mechanical ventilators).

B. If the biological agent causes an illness that results in relatively few deaths (e.g. Venezuelan equine encephalitis, or Q fever), medical care can be effectively provided on the local level. If the disease is one for which specific therapy such as antibiotics is indicated (e.g. tularemia), instructions for obtaining and administering the drugs should be disseminated. For diseases with high mortality and no specific therapy (e.g. yellow fever), instructions for general supportive care that might be provided by non-medical personnel should be disseminated.

C. Although many individuals becoming ill from an attack with a biological weapon would likely undergo medical evaluation over a short time span, all would not become casualties simultaneously, as they would for example, following saturation bombing or a massive surprise attack with nerve gas. An exception to this pattern might be seen following an attack with a biological toxin. Those who have been infected by a biological agent other than a toxin could remain functional for a period of time after the attack (during the incubation period).

D. It may be necessary for one physician, with a small number of ancillary personnel, to care for several hundred patients. Information could be disseminated about the normal course of the disease, the specific signs or symptoms of adverse prognostic significance, the situations requiring individual medical attention or advice, and the procedures for obtaining essential medical supplies.

E. An essential aspect of medical management in such a situation would be to allay panic. This could be done effectively only if everyone in the area (both civilian and military) could be assured that the cause of the illness is known, the course of the disease could be described with reasonable accuracy, and the outcome could be predicted.

4.3. Technical

1. References: FM 3-19, FM 8-9 (Part II), FM 8-10-7, FM 3-9, *USAMRIID's Medical Management of Biological Casualties*, and TC 3-15.
2. Scientific and Medical Basics.

A. Biological Warfare Terminology

(1) Biological Agent (BA). A biological agent is a microorganism, or a toxin derived from a microorganism, which causes disease in man, plants or animals, or which causes the deterioration of material.

(2) Biological Defense (BD). Biological defense includes methods, plans, and procedures to establish and execute defensive measures against biological attack (e.g. vaccination, equipment to mitigate exposure, and training)

(3) Biological Warfare (BW). Biological warfare is the employment of biological agents to produce casualties in man or animals or damage to plants or material.

(4) Biological Weapon. A biological weapon is a weapon that projects, disperses, or disseminates a biological agent or insect vectors of biological agents.

(5) Toxin. A poisonous substance produced or derived from living organisms. Some toxins may also be produced or altered by chemical means. Compared with microorganisms, toxins have a

relatively simple biochemical composition and are not able to reproduce themselves. In many aspects, they are comparable to chemical agents.

B. Characteristics of Biological Agents. Intrinsic features of biologic agents that influence their potential for use as weapons include: incubation periods, infectivity, lethality, pathogenicity, stability, toxicity, transmissibility, and virulence. Unique to many of these agents, and distinctive from their chemical counterparts, is their ability to multiply in the body over time to increase their effect. Additional factors which may influence the suitability of a microorganism or toxin as a biological weapon include: ease of production, stability when stored or transported, and ease of dissemination.

(1) Incubation Period. The time between exposure and the appearance of symptoms.

(2) Infectivity. The relative ease with which microorganisms establish themselves in a host species. Pathogens with high infectivity cause disease with relatively few organisms, while those with low infectivity require a larger number of organisms to cause disease.

(3) Lethality. The ease with which an agent causes death.

(4) Pathogenicity. The capability of an infectious agent to cause disease in a susceptible host.

(5) Stability. Length of time the organism or toxin will remain effective in the environment (also called viability for live organisms). Stability is affected by various environmental factors including temperature, relative humidity, atmospheric pollution, and sunlight.

(6) Toxicity. The relative severity of illness or incapacitation produced by a biological agent.

(7) Transmissibility. The ability of an infectious agent to spread from a source or reservoir to a person. Mechanisms of transmission include: direct transmission, indirect transmission(vehicle-borne, vector-borne), and airborne(droplet nuclei, dust).

(8) Virulence. The degree of pathogenicity of an infectious agent, indicated by case fatality rates and/or its ability to invade and damage tissues of the host.

C. Classification of Biological Agents. Taxonomic classification of biological agents is important in terms of detection, identification, prophylaxis, and treatment. Biological agents which may be used as weapons can be classified as follows:

(1) Bacteria. Bacteria are small free-living organisms, most of which may be grown on solid or liquid culture media. The organisms have a structure consisting of nuclear material, cytoplasm, and a cell membrane. They reproduce by simple division. The diseases they produce often respond to specific therapy with antibiotics.

(2) Viruses. Viruses are organisms that require living cells in which to replicate. Therefore, they are intimately dependent upon the cells of the host that they infect. Their stability in the environment is very variable. They produce diseases which generally do not respond to antibiotics, but which may be responsive to antiviral compounds. However, supportive care (e.g. fluids, anti-inflammatories, and rest) is often the only treatment for viral infections.

(3) Rickettsiae. Rickettsiae are microorganisms that have characteristics common to both bacteria and viruses. Like bacteria, they possess metabolic enzymes and cell membranes, utilize oxygen, and are susceptible to broad-spectrum antibiotics. They resemble viruses in that they grow only within living cells.

(4) Chlamydia. Chlamydia are obligatory intracellular parasites incapable of generating their own energy source. Like bacteria, they are responsive to broad-spectrum antibiotics. Like viruses, they require living cells for multiplication.

(5) Fungi. Fungi are primitive plants that do not utilize photosynthesis, are capable of anaerobic growth, and draw nutrition from decaying vegetable matter. Most fungi form spores. Free-living forms are found in soil. The spore forms of fungi are operationally significant. Fungal diseases may respond to various antimicrobial drugs.

(6) Toxins. Toxins are poisons produced by organisms. The poisons, not the microorganisms that produce the poisons, are harmful to man. Toxins do not grow or reproduce. They are more easily controlled than live organisms (i.e. decontamination is easier). Field monitors capable of providing prompt warning of a toxin attack are not available. Therefore, soldiers must learn to quickly recognize signs of toxin attacks such as observing unexplained symptoms in victims, especially a large number of victims at once. Because the effects on the body are direct, the symptoms of an attack may appear very rapidly. The potency of most toxins are such that very small doses will cause illness and/or death. Thus, an enemy as an alternative to chemical agents may use them because they allow the use of fewer resources to cover the same or a larger area. Slight exposure at the edges of an attack area may produce severe symptoms or death because of extreme toxicity. Illnesses downwind from hazard zones for toxins may be far greater than those of chemical warfare agents. For more information on toxins see FM 3-9, Chapter 4.

3. Detection of Biological Warfare (BW) Agents

A. Actual detection and identification of a biological agent is the only means to prove that such an attack has occurred. Correct and rapid identification of suspected BW agents is politically and medically critical. Biological warfare agents can be identified by a variety of methods at the appropriate laboratory such as:

- (1) Isolation of the etiologic agent by culture (possible in two days for some agents).
- (2) Detection of toxin by mass spectroscopy, animal inoculation, or other methods.
- (3) Antibody detection (specific immunoglobulin may appear in serum within 3 days).
- (4) Antigen detection via enzyme immunoassay or other sensitive assay methods.
- (5) Genome detection employing DNA probes.
- (6) Detection of metabolic products of the agent in clinical specimens.

B. Assistance. These organizations, if present on the battlefield, may help in the determination of a BW attack: BIDS from Chemical Company, TAML (or the newer AML), the Naval Forward Laboratory or CBIRF (Marine). USAMRIID and other TDA organizations can provide additional help. See the Points of Contacts Chapter.

4. Specimen Handling and Shipping for BW.

A. General. Samples will be used for both legal and medical reasons. General policies for collecting samples in order to facilitate identification of biological agents are essential. Medical responsibilities normally are limited to collection and submission of diagnostic materials from patients. Environmental sampling (e.g. of soil, water, food, and animal remains) is an important element in corroborating the occurrence of a BW attack, and is usually conducted by preventive medicine, veterinary support teams, and NBC Reconnaissance Units such as the BIDS. In this section, the term sample will refer to materials of non-human and non-animal origin, such as water or food samples. The term 'specimen' refers to material of human or animal origin.

B. **Sample/Specimen Collection.** Sample/specimen collectors should use full protective gear. If the specimen or sample is to be tested for biological agents, it must be marked as such. Great care should be used to prevent cross-contamination of one sample/specimen by another. Routine medical sampling procedures will be modified so that proving and documenting the BW attack occurred. Contact TAML, USAMRIID, the unit's Chemical Officer and Technical Escort for additional help.

C. **Human Tissue Samples.** Blood culture with routine media will readily detect many bacterial agents. Both aerobic and anaerobic cultures should be obtained routinely. Cultures and impression smears should be taken from involved lymph nodes, sputum, pleural fluid, cerebrospinal fluid (CSF), and spleen when possible. Acute serum (at least 3 ml for suspected infectious agents, and at least 20 ml for suspected intoxications) should be collected as early as possible after onset of symptoms and shipped frozen to a reference laboratory. Blood samples also should be obtained from exposed persons who are not yet symptomatic. Convalescent sera from survivors and unaffected unit members should be obtained 3-4 weeks later. Samples for isolation of suspected viral agents should be obtained from organs and tissues as described above, placed in specialized transport media, and frozen for shipment to specified reference laboratories. Tissue samples obtained at autopsy should be collected in multiple aliquots. At a minimum, obtain one 25-50 gram sample to freeze for microbiology or toxicology and one 25-50 gm sample in formalin for histopathology. If samples are needed for specialized procedures such as immunofluorescence or polymerase chain reaction studies, additional or specific specimens should be obtained. Organs sampled should include lung, mediastinal lymph nodes, spleen, liver, and kidneys. Obvious lesions and adjacent normal tissue should be taken from affected areas in any organ. Postmortem blood (up to 20 ml) should also be obtained. Contact TAML, USAMRIID, or USACHPPM for more information on types of samples to collect and specific procedures for collection.

D. **Animal Tissue Samples.** The advantage of veterinary sample collecting is that one can get much fresher samples than in human medicine, i.e. one can collect from freshly dead animals before they are at risk of decomposing. Animal tissue samples must be handled in the same careful manner as human tissue samples. The types of samples obtained are also the same as those described above for human tissue sampling. Veterinary and PM personnel will usually collect animal tissue samples. All animal tissues should be reasonably fresh (i.e. not decomposed). Veterinary expertise, or experience in appropriate collection of tissues, is essential to obtaining a valid sample for analysis. For example, if samples are being tested for viruses, they must be quick-frozen with liquid nitrogen. Other tissues may have to be maintained on dry or wet ice. The principles for sample preparation and management are the same as those used for collection and preservation of human tissue samples. If veterinary personnel are not available, human medical resources can give guidance with regard to the proper preservation of particular samples. Non-veterinary personnel should NEVER attempt to capture animals, or handle live/injured animals for sample collection as this could lead to serious injury and possible infection with a biological agent. The only exception to this policy may be the live capture of rodents by appropriately trained PM personnel. The TAML has both veterinary and PM expertise to perform or give guidance on appropriate collection of animal tissue samples, as well as expertise on sample handling and shipment, and testing of samples for biological agents.

E. **Food/Water/Plant/Insect Samples:** These types of samples should be collected by PM or Veterinary Food Inspection units.

F. **Specimen Labeling.** Each container should be labeled with patient's name or animal/plant/insect number, numerical identifier, type of specimen, and date of collection. Include a brief description of

the illness and gross autopsy findings; place, date, and time of death; place, date, and time of collection; pathologist; unit; medical facility, and medical facility to receive results (if different from submitting facility). All serum samples should be completely labeled with patient's name or animal/plant/insect number, sample numerical identifier, unit, date, unit, originating medical facility, and medical facility to receive results (if different from submitting facility). Routine laboratory slips should be included with each sample. Data on laboratory slips should include number of days since onset of symptoms and the reason that samples were obtained. Clinical and operational data should be included for all samples, together with a chain of custody form. This requirement must be strongly and clearly delineated since evidence may well be politically or militarily disputed.

G. Specimen Handling and Shipment. Samples for microbiological or toxicological analysis should be kept as cold as possible, preferably frozen. Formalin-fixed material must not be frozen. Specific guidance of temperature control and type of transport media should be obtained from the technical expert POC at the identification laboratory. Serum should be contained in plastic screw-cap vials, which are securely sealed. If possible, each serum sample should be individually placed in a second plastic vial or zip-top bag to prevent leakage. All specimens should be contained in a metal shipping can or other secondary container. Sufficient absorbent material should be packed to prevent leakage outside the container. The entire contents should be placed in an insulated shipping container with cold packs or dry ice. Tech Escort units can secure and transport possible BW samples.

H. It is the responsibility of the laboratory officer, in concert with the veterinarian, preventive medicine officer or physician, to ensure that suspect specimens are submitted correctly and expeditiously to an appropriate diagnostic laboratory. Unusual or unique situations may require direct contact with the testing laboratory prior to submission of samples/specimens. This will confirm the number, kind, and special preparation of samples needed to accurately identify a BW agent. Samples should not be given to the laboratory of a MTF for analysis. They should go to the designated supporting laboratory. This will avoid the risk of introducing a biological agent to the MTF. The TAML, a Chemical Corps BIDS unit, or Navy land-based laboratory may be the nearest laboratory supporting a MTF that can assess samples/specimens for BW agents. CONUS laboratories (See FM 8-10-7, Appendix G) would make backup confirmation of BW activity.

I. All specimens from suspected BW casualties, animals, or other samples should be submitted through the routine diagnostic laboratory chain for processing. Samples must be clearly marked for special diagnostic testing, and chain-of-custody procedures maintained. Use DA Form 4137 (Evidence/ Property Custody Document) to accompany the samples or specimens from the point of collection to the final receiving laboratory. Ensure that the time frame for delivery to the supporting laboratory is clearly delineated on the sample container to avoid unnecessary delay and possible deterioration of the sample. Each person receiving the samples/specimens will sign the document. Chain of Custody procedures are described more fully in FM 8-10-7, Appendix G. Detailed sampling techniques are described in FM 3-19 and briefly dealt with in FM 3-3. Further sampling activities (reconnaissance, monitoring and survey) are described in FM 3-3, Chapter 5.

5. Technical Expert POC. The following organizations would likely be most helpful in responding to a BW incident (see Chapter 10, Points of Contacts for their phone numbers and location.):
 - A. Corps (or appropriate) Chemical Officer - in charge of the NBC defense for the unit.
 - B. Technical Escort Unit - transportation of suspected biological agents and samples.

C. AFMIC - to obtain medical intelligence of naturally occurring disease or enemy capabilities.

D. 520th TAML/AML - first theater-level laboratory that can provide specific assistance in sample collection and analysis.

E. USAMRIID - CONUS assistance in specimen collection and analysis. Expertise in disease pathogenesis and treatment.

F. WRAIR - CONUS assistance with diagnostic testing, disease pathogenesis, or treatment of patients with BW illnesses.

G. CDC - civilian CONUS expertise with diagnostic testing, sample management, disease pathogenesis, and treatment.

4.4. Biological Agent Operational Data Charts

Table 4-E: BW Agents, Scientific Names or Toxin Source and Type

Agent	Infectious Agent or Source	Type	Weaponized
Anthrax	<i>Bacillus anthracis</i>	Bacteria	Yes
Brucellosis	<i>Brucella abortus</i> , <i>B. melitensis</i> , <i>B. suis</i> , <i>B. canis</i>	Bacteria	Yes
Tularemia	<i>Francisella tularensis</i>	Bacteria	Yes
Glanders	<i>Burkholderia mallei</i>	Bacteria	Probable
Melioidosis	<i>Pseudomonas pseudomallei</i>	Bacteria	Possible
Shigellosis	<i>Shigella</i>	Bacteria	Unknown
Salmonellosis	<i>Salmonella typhimurium</i> , <i>S. enteritidis</i>	Bacteria	
Cholera	<i>Vibrio cholerae</i>	Bacteria	Unknown
Typhoid fever	<i>Salmonella typhi</i>	Bacteria	Unknown
Plague	<i>Yersinia pestis</i>	Bacteria	Probable
Q fever	<i>Coxiella burnetii</i>	Rickettsia	Yes
Epidemic Typhus	<i>Rickettsia prowazekii</i>	Rickettsia	Probable
Scrub Typhus	<i>Rickettsia tsutsugamushi</i>	Rickettsia	Probable
Psittacosis	<i>Chlamydia psittaci</i>	Chlamydial	Possible
Rocky Mountain spotted fever	<i>Rickettsia rickettsii</i>	Rickettsia	Unknown
Argentine hemorrhagic fever (Junin)	Tacaribe Virus complex Arenavirus	Virus	Probable
Bolivian hemorrhagic fever (Muchupo)	Tacaribe Virus complex Arenavirus	Virus	Probable
Chikungunya hemorrhagic fever	<i>Alphavirus</i>	Virus	Probable
Crimean-Congo hemorrhagic fever (CCHF)	<i>Nairovirus</i>	Virus	Probable
Korean hemorrhagic fever (Hantaan)	Bunyavirus	Virus	Probable
Omsk hemorrhagic fever	<i>Flavivirus</i>	Virus	Probable
Lassa fever	Arenavirus	Virus	Probable

Agent	Infectious Agent or Source	Type	Weaponized
Smallpox	<i>Orthopoxvirus</i>	Virus	Probable
Influenze	<i>Influenzavirus</i>	Virus	Probable
Hepatitis A		Virus	Unknown
Dengue fever	<i>Flavivirus</i>	Virus	Unknown
Marburg	Filovirus	Virus	
Ebola	Filovirus	Virus	Unknown
Eastern equine encephalitis (EEE)	<i>Alphavirus</i>	Virus	
Western equine encephalitis (WEE)	<i>Alphavirus</i>	Virus	
Russian spring-summer encephalitis	Flavivirus	Virus	
Venezuelan equine encephalitis (VEE)	<i>Alphavirus</i>	Virus	
Rift Valley fever	<i>Phlebovirus</i>	Virus	
Yellow fever	<i>Flavivirus</i>	Virus	
Coccidioidomycosis	<i>Coccidioides immitis</i>	Fungal	
Histoplasmosis	<i>Histoplasma capsulatum</i>	Fungal	
Cryptosporidiosis	<i>Cryptosporidium</i> spp.	Protozoan	Unknown
Botulinum toxins	<i>Clostridium botulinum</i>	Biotoxin	Yes
T-2 mycotoxins (yellow rain)	Mycotoxins of the Trichothecence group	Biotoxin	Probable
Aflatoxin		Biotoxin	Yes
Ricin	Seed of castor plant	Biotoxin	Yes
Staphylococcal enterotoxins (SEB)	<i>Staphylococcus aureus</i>	Biotoxin	Probable
Microcystins	Blue-green algae	Biotoxin	Possible
Anatoxin A	Blue-green algae	Biotoxin	Unknown
Tetrodotoxin	Puffer-fish	Biotoxin	Possible
Saxitoxin	Marine dinoflagellate	Biotoxin	Possible
<i>Clostridium perfringens</i> toxins	<i>Clostridium perfringens</i>	Biotoxin	Probable
Palytoxin	Marine soft coral	Biotoxin	
Abrin	Rosary pea	Biotoxin	
Tetanus Toxin	<i>Clostridium tetani</i>	Biotoxin	
Modeccin		Biotoxin	

*This is not intended to be comprehensive, nor should it be interpreted as a sanctioned "threat list."

Reference: Table A-I from FM 8-9, Part II and Medical Issues Information Paper No. IP-31-017, "Biological Warfare Agents as Potable Water Threats". USACHPPM.

Benenson, A.S. (1990). Control of Communicable Diseases in Man. American Public Health Association, 15th edition. Washington, DC.

Table 4-F: Bacteria Operational Data

Disease	Likely Methods Of Dissemination	Transmissibility Man to man	Infectivity	Incubation time*	Duration of illness	Lethality	Persistence	Vaccination	Antimicrobial therapy	Antisera
(Inhalation) Anthrax	Spores in aerosols	No	Moderate	1-6 days	3-5 days	High	Spores are highly stable	Yes	Effective early, Otherwise little effect	Experimental
Brucellosis	1. Aerosol 2. Sabotage (food supply)	Via contact with lesions	High	5-60 days	Weeks to years	Low	Long persistence in wet soil & food	No	Moderately effective	No
Cholera	1. Sabotage (food/water supply) 2. Aerosol	Negligible	Low	1-5 days	1 or more weeks	Moderate to high	Unstable in aerosols & pure water. More persistence in polluted water	Yes	Moderately effective	No
Melioidosis	Aerosol	Negligible	High	Days to year	4-20 days	Variable	Stable	None	Moderately effective	No
(Pneumonic) Plague	1. Aerosol 2. Infected vectors	High	High	2-3 days	1-2 days	Very high	Less important because of high transmissibility	Yes	Moderately effective	No
Tularemia	Aerosol	No	High	2-10 days	2 or more weeks	Moderate if untreated	Not very stable	Yes	Effective	No
Typhoid fever	1. Sabotage (food/water supply) 2. Aerosol	Negligible	Moderate	7-21 days	Several weeks	Moderate if untreated		Yes	Moderately effective	No

* Incubation applies to infectious diseases. With toxins, it's application refers to the period between exposure and appearance of the symptoms and signs of poisoning.

Reference: Table C-I from FM 8-9 (Part II).

Table 4-G: Rickettsiae, Chlamydia and Fungal Operational Data

Disease	Likely Methods of Dissemination	Transmissibility Man to man	Infectivity	Incubation time*	Duration of illness	Lethality	Persistence	Vaccination	Antimicrobial therapy	Antisera
Epidemic Typhus	1. Aerosol 2. Infected vectors	No	High	6-16 days	Weeks to months	High	Not very stable	No	Effective	No
Q fever	1. Aerosol 2. Sabotage (food supply)	No	High	10-20 days	2 days to 2 weeks	Very low	Stable	Yes	Effective	No
Rocky Mountain spotted fever	1. Aerosol 2. Infected vectors	No	High	3-10 days	2 weeks to months	High	Not very stable	No	Effective	No
Scrub Typhus	1. Aerosol 2. Infected vectors	No	High	4-15 days	Up to 16 days	Low	Not very stable	No	Effective	No
Psittacosis	Aerosol	Negligible	Moderate	4-15 days	Weeks to months	Very low	Stable	No	Effective	No
Coccidioidomycosis	Aerosol	No	High	1-2 weeks	Weeks to months	Low	Stable	No	Not very effective	No
Histoplasmosis	Aerosol	No	High	1-2 weeks	Weeks to months	Low	Long persistence in soil	No	Not very effective	No

* Incubation applies to infectious diseases. With toxins, it's application refers to the period between exposure and appearance of the symptoms and signs of poisoning.
Reference: Tables C-II and C-III from FM 8-9 (Part II).

Table 4-H: Toxins Operational Data

Disease	Likely Methods of Dissemination	Transmissibility Man to man	Infectivity	Incubation time*	Duration of illness	Lethality	Persistence	Vaccination	Antimicrobial therapy	Antisera
Botulinum toxin	1. Sabotage (food/ water supply) 2. Aerosol	No		Variable (hours to days)	24-72 hours Months if lethal	High	Stable	Yes	Not effective	Yes
<i>Clostridium Perfringens</i> Toxins	1. Sabotage 2. Aerosol	No		8-12 hours	24 hours	Low	Stable	No	Not effective	No
Trichothecene mycotoxins	1. Aerosol 2. Sabotage	No		Hours	Hours	High	Stable	No	Not effective	No
Palytoxin	1. Aerosol 2. Sabotage	No		Minutes	Minutes	High	Stable	No	Not effective	No
Ricin	Aerosol	No		Hours	Days	High	Stable	Under development	Not effective	No
Saxitoxin	1. Sabotage 2. Aerosol	No		Minutes to hours	Minutes to days	High	Stable	No	Not effective	No
Staphylococcal enterotoxin B	1. Aerosol 2. Sabotage	No		1-6 hours	Days to weeks	Low	Stable	Under development	Not effective	No
Tetrodotoxin	1. Sabotage 2. Aerosol	No		Minutes to hours	Minutes to days	High	Stable	No	Not effective	No

* Incubation applies to infectious diseases. With toxins, it's application refers to the period between exposure and appearance of the symptoms and signs of poisoning.

Reference: Table C-V from FM 8-9 (Part II).

Table 4-I: Viruses Operational Data

Disease	Likely Methods of Dissemination	Transmissibility Man to man	Infectivity	Incubation time*	Duration of illness	Lethality	Persistence	Vaccination	Antimicrobial therapy	Antisera
Chikungunya fever	Aerosol	None	High	2-6 days	2 weeks	Very low	Relatively stable	Experimental	Not effective	No
Crimean-Congo hemorrhagic Fever	Aerosol	Moderate	High	3-12 days	Days to weeks	High	Relatively stable	Experimental (Bulgaria)	Effective	Yes (Bulgaria only)
Dengue fever	Aerosol	None	High	3-6 days	Days to weeks	Low	Relatively unstable	Experimental	Not effective	No
Eastern equine encephalitis	Aerosol	None	High	5-15 days	1-3 weeks	High	Relatively unstable	Yes	Not effective	No
Ebola	Aerosol	Moderate	High	7-9 days	5-16 days	High	Relatively unstable	No	Not effective	No
Korean hemorrhagic fever (Hantaan)	Aerosol	None	High	4-42 days	Days to weeks	Moderate	Relatively stable	Experimental	Effective	No
Lassa fever	Aerosol	Low to moderate	High	10-14 days	1-4 weeks	Unknown	Relatively stable	No	Effective	Experimental
Omsk hemorrhagic fever	1. Aerosol 2. Water	Negligible	High	3-7 days	7-10 days	Low	Relatively unstable	Experimental	Not effective	No

Disease	Likely Methods of Dissemination	Transmissibility Man to man	Infectivity	Incubation time*	Duration of illness	Lethality	Persistence	Vaccination	Antimicrobial therapy	Antisera
Rift Valley fever	1. Aerosol 2. Infected vectors	Low	High	2-5 days	Days to weeks	Low	Relative stable	Yes	Not effective	No
Russian spring-summer encephalitis	1. Aerosol 2. Milk	None	High	8-14 days	Days to months	Moderate	Relatively unstable	Yes	Not effective	Yes
Smallpox	Aerosol	High	High	10-17 days	1-2 weeks	High	Stable	Yes	Not effective	Yes
Western equine encephalitis	Aerosol	No	High	1-20 days	1-3 weeks	Low	Relatively unstable	Yes	Not effective	No
Venezuelan equine encephalitis	1. Aerosol 2. Infected vectors	Low	High	1-5 days	Days to weeks	Low	Relatively unstable	Yes	Not effective	No
Yellow fever	Aerosol	None	High	3-6 days	1-2 weeks	High	Relatively unstable	Yes	Not effective	No

* Incubation applies to infectious diseases. With toxins, it's application refers to the period between exposure and appearance of the symptoms and signs of poisoning.

Reference: Table C-IV from FM 8-9 (Part II).

4.5. Medical

1. References: AMedP-8, FM 8-9 (Part II), FM 3-6, FM 8-33, and USAMRIID's *Handbook on Medical Management of Biological Casualties*. Annex D of FM 8-9 (Part II) gives a model for an approach to the acutely ill febrile patient.
2. Casualty Predictions following a Biological Agent Attack. Casualty predictions for BW attacks are difficult to estimate as many factors need to be taken into consideration to include, the agent deployed, environmental conditions, number of personnel exposed, and the weapon or means of sabotage by which the BW agent is used. AmedP-8 Medical Planning Guide of NBC Battle Casualties, Volume II (Draft) provides some guidance on casualty estimates for BW agents.
3. Medical Symptoms Expected Following a Biological Agent Attack. See the above reference for details on clinical syndromes, diagnosis, therapy, and prophylaxis for biological agents. There is also information on microbiology, principal threat agents (including toxins), and diseases caused by biological agents in FM 3-6, *Technical Aspects of Biological Warfare Agents* (Draft, 1997). Also see USAMRIID's *Handbook on Medical Management of Biological Casualties*.
4. General Treatment Measures.
 - A. Supportive Measures. Measures should be taken to lower temperature; relieve pain; maintain spontaneous respiration; and secure an intravenous access for the administration of drugs and fluids. Symptomatic treatment and treatment of coexisting injuries should follow established principles.
 - B. Isolation Procedures (Barrier Nursing). In the context of biological agent casualties, adherence to principles of patient isolation is essential to preventing cross-infection with transmissible agents.
 - C. Antibiotic Therapy. Antibiotics must be given to all BW casualties, even without a firm diagnosis, and commenced at the earliest possible level of medical care.
 - D. Antiviral Therapy. The only "broad-spectrum" antiviral drug currently available is ribavirin. This compound has been a useful nonspecific adjunct to the treatment of some potential viral threats. Ribavirin is an investigational antiviral drug available via compassionate use protocols for therapy of Lassa fever, hemorrhagic fever with renal syndrome (HFRS), Crimean-Congo hemorrhagic fever, and Rift Valley fever. Ribavirin has poor in vitro and in vivo activity against the filoviruses (Marburg and Ebola) and the flaviviruses (Dengue fever, Yellow fever, Omsk HF, and Kyanasur Forest disease).
 - E. Antitoxin Therapy. Broad-spectrum antitoxins do not currently exist. However, specific antitoxins are available for certain conditions. Several antitoxins may be available for post-exposure use in individuals exposed to botulinum toxins.
 - F. Vaccination. Vaccination is the preferred method of biological defense. Fully licensed vaccines are currently available for anthrax, cholera, plague and smallpox. Vaccines for botulinum toxoid, Q fever, Rift Valley fever, tularemia, and VEE currently exist as IND products and would be available only under protocol with informed consent, therefore would not be readily available on the battlefield. No vaccine is currently available either FDA licensed or under IND status, for glanders, brucellosis, Staphylococcus enterotoxin B, ricin, or T-2 mycotoxins.

Table 4-J: Types and Characteristics of Some Biological Agents

Type of Agent	Stability	Incubation Time	Entrance	
			Aerosol	Other Routes
Anthrax	High	1 to 6 days	Inhalation	Mouth, Skin
Botulinum toxin	High	24 to 36 hours	Inhalation	Mouth, Wound
Brucellosis	High in wet environment	1 to 4 weeks	Inhalation	Mouth, Skin, Eyes
Bunyavirus (LA Crosse)				Mosquito
Cholera	Moderate	Hours to 5 days	None	Mouth
Crimean-Congo hemorrhagic fever		3 to 7 days	Inhalation	Tick, Contact (Skin)
Dengue fever		4 to 10 days		Mosquito
Diphtheria		2 to 5 days	Inhalation	
Eastern equine encephalitis		4 to 24 days		Vector
Hantaan virus			Inhalation	Vector
Japanese B encephalitis		5-15 days		Mosquito
Phlebovirus		3 to 6 days		Sandfly
Plague (Bubonic)	Moderate	2 to 10 days	None	Bite of Vector
Plague (Pneumonic)	Low	2 to 3 weeks	Inhalation	
Q fever	High	2 to 3 weeks	Inhalation	Ingestion
Ricin	High	<36 hours	Inhalation	Mouth, air-guns
Rickettsia (endemic or flea-borne typhus)		1 to 2 weeks		Vector
Rickettsia (Rocky Mountain spotted fever)		3 to 10 days		Vector
<i>Rickettsia</i> Spp.		6 to 15 days		Vector
Rift Valley fever		4-6 days		Mosquito, butchering sick and dead animals
Russian spring-summer encephalitis		7 to 14 days		Tick
Smallpox		7 to 16 days	Inhalation	Contact/ mucous membranes
Staphylococcal enterotoxin B	High	1 to 6 hours	Inhalation	Mouth
Trichothecene mycotoxin	High	Minutes to hours	Inhalation	Mouth, Skin
Tularemia	Low	2 to 10 days	Inhalation	Mouth, Animal, Vector
Typhoid		6 to 21 days		GI tract, Mouth
Venezuelan equine encephalitis		4 to 24 days		Vector
Yellow fever		3 to 6 days		Mosquito

References: Table 2-9 from FM 8-10-7 and Table 5-2 from FM 3-7.

Table 4-K: Potential BW Agents by Predominant Clinical Finding or Syndrome

Syndrome	General characteristics	Potential Causes *
Fever		Any (Toxins less likely)
Grippe-like	Fever, chills, malaise, headache, Myalgia, eye pain, hyperaesthesias	Brucellosis, Rift Valley fever, Venezuelan equine encephalitis, Q-fever, Influenza, Dengue fever, Chikungunya fever, Inhalation anthrax (early)
Pharyngitis	Sore throat, dysphagia, with or without fever	Lassa, Botulinum toxins, Ebola/Marburg, Tularemia, Trichothecene mycotoxins, Ricin
Rash-maculopapular	All rash syndromes typically accompanied by fever	Rocky Mountain spotted fever, Scrub typhus, Epidemic typhus, Ebola/Marburg, Argentine hemorrhagic fever, Bolivian hemorrhagic fever, Dengue fever, Chikungunya fever, Tularemia (uncommon), Psittacosis (uncommon), Smallpox (early)
Rash-vesiculopustular		Smallpox, Melioidosis, Glanders, Tularemia
Rash-granulomatous or ulcerative		Melioidosis, Glanders, Tularemia
Rash-petechial/ Ecchymotic		Korean hemorrhagic fever, Crimean-Congo hemorrhagic fever, Rocky Mountain spotted fever, Plague, Smallpox (rare, fulminant), Argentine hemorrhagic fever, Bolivian hemorrhagic fever, Lassa, Dengue fever, Ebola/Marburg, Rift Valley fever (infrequent), Omsk hemorrhagic fever, Yellow fever, Scrub typhus, Epidemic typhus, Trichothecene mycotoxins
Diarrhea-dysentery	Typically with fever	Shigella
Diarrhea, watery	With or without fever	Cholera, Staphylococcal enterotoxin B, Lassa, Ebola/Marburg, Salmonellosis
Jaundice	With or without fever	Yellow fever, Lassa, Ebola/Marburg, Toxins (especially aflatoxin)
Hemorrhagic fever	Fever; hypotension, with or Without fever	Lassa, Ebola/Marburg, Crimean-Congo hemorrhagic fever, Omsk hemorrhagic fever, Argentine hemorrhagic fever, Bolivian hemorrhagic fever, Yellow fever, Dengue fever, Trichothecene mycotoxins, Plague, Korean hemorrhagic fever, Rift Valley fever (infrequent)
Encephalitis/ Encephalopathy	With or without fever	Eastern/Western/Venezuelan equine encephalitis, Russian spring-summer encephalitis, Argentine hemorrhagic fever, Bolivian hemorrhagic fever, Lassa, Psittacosis, Plague, Rift Valley fever (infrequent)
Stiff neck syndrome	Typically with fever	Eastern/Western/Venezuelan equine encephalitis, Psittacosis, Histoplasmosis
Flaccid paralysis	Sensory paresthesias, flaccid Weakness, cranial nerve abnormalities	Botulinum toxins, Saxitoxin, Tetrodotoxin
Oliguric renal failure	Typically with fever	Korean hemorrhagic fever, Yellow fever, Psittacosis (rarely)
Pulmonary syndrome	Pneumonia, respiratory insufficiency, Respiratory distress	Anthrax, Tularemia, Plague, Psittacosis, Q fever, Histoplasmosis, Coccidiomycosis, Influenza, Omsk hemorrhagic fever, Crimean-Congo hemorrhagic fever, Korean hemorrhagic fever, Ricin, Staphylococcus enterotoxin B, Botulinum toxin
Polyarthritis/polyarthralgia	Typically with fever	Chikungunya fever
Rapid death syndrome	Death within minutes; fever may Be present	Saxitoxin, Tetrodotoxin, Botulinum toxins, Trichothecene mycotoxins, Other toxins, Chemical agents, Anthrax

* This list is comes from FM 8-9 (Part II) is cross-referenced to Annex A of that manual, and is not intended to be comprehensive. It does not suggest that clinical presentation of a given agent will necessarily be that of a syndrome listed. This table should serve only as a guide; additional clinical findings must be considered in each case in an attempt to obtain a definitive diagnosis.

Reference: Table D-II from FM 8-9 (Part II).

Table 4-L: Differentiation Among Botulinum, Nerve Agent, and Atropine

Item	Botulinum toxin	Nerve Agent	Atropine Intoxication
Sensorium	Usually normal.	Disorientation, agitation, coma, seizures.	Disorientation, excitation, agitation, irritability, coma.
Ocular abnormalities	Dilated and fixed pupils, distorted blurred vision, ptosis, extraocular muscle paralysis.	Constricted pupils, dim vision (if vapor), little if any change if exposed via skin.	Weak effects if usual doses given causing pupillary dilation and paralysis of accommodation.
Paralysis	Flaccid paralysis. Early bulbar signs (dysphonia dysphagia) descending to upper and lower extremities. Respiratory failure.	Rigid paralysis with twitching, jerking. Seizures.	None of significance.
Autonomic findings	Dry mouth and skin, constipation, ileus, urinary retention. Early emesis and diarrhea after food ingestion.	Excess salivation, increased sweating, involuntary defecation and urination. Severe rhinorrhea and bronchoconstriction if exposure is by inhalation.	Dry mouth and skin, constipation, ileus, urinary retention. Early emesis and diarrhea after food ingestion.
Onset	24-36 hours by inhalation exposure. Not absorbed through intact skin; 12-72 hours onset by oral exposure.	1-10 minutes by inhalation exposure; 1-2 hours by dermal exposure.	Minutes after injection, can be exacerbated by dehydration and heat exposure.

Reference: Table D-I from FM 8-9 (Part II).

Table 4-M: Infective Dose and Diagnostic Sample Assays of Biological Agents

Agent	Infective Dose (Aerosol)	Diagnostic Samples	Diagnostic Assay	Patient Isolation Precautions
Anthrax	8000-50,000 spores	Blood	Gram stain, Ag-ELISA, serology: ELISA	Standard Precautions
Brucellosis	10-100 organisms	Blood, bone marrow, acute and convalescent sera	Serology: agglutination, culture	Standard Precautions, Contact isolation if draining lesions
Plague	100-500 organisms	Blood, sputum, lymph node aspirate	Gram or Wright-Giemsa stain, Ag-ELISA, Culture, Serology: ELISA, IFA	Pneumonic: droplet precautions until patient treated for 3 d
Q fever	1-10 organisms	Serum	Serology: ELISA, IFA	Standard Precautions
Tularemia	10-50 organisms	Blood, sputum, serum, EM of tissue	Culture, Serology: agglutination	Standard Precautions
Smallpox	Assumed low 10-100 organisms	Pharyngeal swab, scab material	ELISA, PCR, viral isolation	Airborne Precautions
Viral encephalitides	10-100 organisms	Serum	Viral isolation, Serology: ELISA or hemagglutination inhibition	Standard Precautions (mosquito control)
Viral hemorrhagic fevers	1-10 organisms	Serum, blood	Viral isolation, Ag-ELISA, RT-PCR, Serology: Ab-ELISA	Contact Precautions
Botulinum	0.001 ug/kg (type A)	Nasal swab	Ag-ELISA, Mouse neural	Standard Precautions
SEB	30 ng/person (incapacitating) 1.7 ug/person (lethal)	Nasal swab, serum, urine	Ag-ELISA, Serology: Ab-ELISA	Standard Precautions

Reference: Franz, et al., JAMA, Vol 278 #5, August 6, 1997

4.6. Detailed Description of Some Biological Agents

1. References: FM 8-9 (Part II), FM 8-33, and USAMRIID's *Handbook on Medical Management of Biological Casualties*, and USAMRMC's *Medical Products for Supporting Military Readiness, Vaccines & Drugs (GO BOOK)*. A model for an approach to the acutely ill febrile patient is found in Annex D of FM 8-9 (Part II).
2. Anthrax (*Bacillus anthracis*).

A. Characteristics. Anthrax is a zoonotic disease caused by *Bacillus anthracis*. Under natural conditions, humans become infected by contact with infected animals or contaminated animal products. Human anthrax is usually manifested by cutaneous lesions. A biological warfare attack with anthrax spores delivered by aerosol would cause inhalation anthrax, an extraordinarily rare form of the naturally occurring disease. Since Anthrax is a zoonotic disease, deaths in cattle and sheep coincident with human cases may indicate an anthrax attack.

B. Clinical Features. The disease begins after an incubation period varying from 1-6 days, presumably dependent upon the dose of inhaled organisms. Onset is gradual and nonspecific, with fever, malaise, and fatigue, sometimes in association with a nonproductive cough and mild chest discomfort. In some cases, there may be a short period of improvement. The initial symptoms are followed in 2-3 days by the abrupt development of severe respiratory distress with dyspnea, diaphoresis, stridor, and cyanosis. Physical findings may include evidence of pleural effusions, edema of the chest wall, and meningitis. Shock and sudden death can occur within four hours of respiratory symptom and fever onset.

C. Vaccine. A licensed, formalin-inactivated cellular supernatant vaccine comprising the *B. anthracis* protective antigen (PA) has been shown to be effective in preventing inhalation anthrax. Antibody against protective antigen develops in 85-95% after initial 3 doses, and in 100% after 12-month dose. The vaccine should be stored at refrigerator temperature (not frozen). The US Army is currently vaccinating troops against Anthrax.

D. Antibiotics. If a biological weapon attack is imminent or cases have just been diagnosed, prophylaxis with ciprofloxacin or doxycycline is recommended. Effectiveness of antibiotic use will depend on how early treatment is started and the antibiotic sensitivity of the organism. Case-fatality rate is high following onset of pulmonary signs and symptoms.

3. Botulinum toxin.

A. Characteristics. Botulism is caused by intoxication with any of the seven distinct neurotoxins produced by the bacillus *Clostridium botulinum*. The toxins are proteins that bind to the presynaptic membrane of neurons at peripheral cholinergic synapses to prevent release of acetylcholine and block neurotransmission.

B. Clinical Features. A biological warfare attack with botulinum toxin delivered by aerosol would be expected to cause symptoms similar in most respects to those observed with food-borne botulism. Symptoms of inhalation botulism may begin as early as 24-36 hours, or as late as several days, following exposure. Initial symptoms include ptosis, generalized weakness, lassitude, and dizziness. Diminished salivation with extreme dryness of the mouth and throat may cause complaints of a sore throat. Urinary retention or ileus may also occur. Motor symptoms usually are present early in the

disease; cranial nerves are affected first with blurred vision, diplopia, ptosis, and photophobia. Bulbar nerve dysfunction causes dysarthria, dysphonia, and dysphagia. This is followed by a symmetrical, descending, progressive weakness of the extremities along with weakness of the respiratory muscles. Development of respiratory failure may be abrupt.

C. Vaccine/Prophylaxis. A formalin-inactivated toxoid of botulinum toxins Types A, B, C, D, and E (pentavalent vaccine) is available under investigational vaccine status by the Army and CDC. The vaccine provides countermeasure to five of the seven neurotoxins (Types A through E). The currently recommended schedule induces solidly protective antibody levels in greater than 90 percent of those vaccinated after 1 year. The vaccine should be stored at refrigerator temperatures (not frozen). Other available countermeasures include two antitoxin preparations available for post-exposure use in individuals exposed to botulinum toxins and may be effective if given early in the course. Available from CDC is a trivalent licensed antitoxin against Types A, B, and E. A heptavalent antitoxin against Types A through G is available as an IND product from USAMRIID available only under protocol with informed consent.

4. Brucellosis (*Brucella* species).

A. Characteristics. Brucellosis is a systemic zoonotic disease caused by one of four species of bacteria: *Brucella melitensis*, *B. abortus*, *B. suis*, and *B. canis*; virulence for humans decreases somewhat in the order given. These bacteria are small gram-negative, aerobic, non-motile coccobacilli that grow within monocytes and macrophages. They reside quiescently in tissue and bone-marrow, and are extremely difficult to eradicate even with antibiotic therapy. Their natural reservoir is domestic animals, such as goats, sheep, and camels (*B. melitensis*); cattle (*B. abortus*); and pigs (*B. suis*). *B. canis* is primarily a pathogen of dogs, and only occasionally causes disease in humans. When used as a biological warfare agent, brucellae would most likely be delivered by the aerosol route; the resulting infection would be expected to mimic natural disease. Terrorist and partisans would most likely spread Brucellosis through contamination of dairy products.

B. Clinical Features. Brucellosis presents after an incubation period normally ranging from 3-4 weeks, but may be as short as 1 week or as long as several months. Clinical disease presents typically as an acute, non-specific febrile illness with chills, sweats, headache, fatigue, myalgia, arthralgia, and anorexia. Cough occurs in 15-25% of patients, but chest radiographs are usually normal. Complications include: sacroiliitis, arthritis, vertebral osteomyelitis, epididymo-orchitis, and rarely, endocarditis. *B. melitensis* may result in a 30-40% casualty fatality rate.

C. Vaccine. Live animal vaccines are widely used. Killed and live attenuated human vaccines have been available in many countries but are of unproven efficacy. No approved human vaccine is available at this time.

5. Cholera (*Vibrio cholerae*)

A. Characteristics. Cholera is a diarrheal disease caused by *Vibrio cholerae*, a short, curved, gram-negative bacillus. Humans acquire the disease by consuming water or food contaminated with the organism. The organism multiplies in the small intestine and secretes an enterotoxin that causes a secretory diarrhea. When employed as a BW agent, cholera will most likely be used to contaminate water supplies. It is unlikely to be used in aerosol form.

B. Clinical Features. Cholera may present as mild diarrhea or as a fulminant disease characterized by profuse watery diarrhea with fluid losses exceeding 5 to 10 liters or more per day. Without

treatment, death may result from severe dehydration, hypovolemia and shock. Vomiting is often present early in the illness and may complicate oral replacement of fluid losses. There is little or no fever or abdominal pain.

C. Vaccine. Vaccination with the FDA Licensed, currently available, killed suspension of *V. cholerae* provides about 50% protection that lasts for no more than 6 months. Vaccine consists of sterile suspension of equal parts of phenol-killed Ogawa and Inaba serotypes of *V. cholerae*. The initial dose is two injections given at least 1 week apart with booster doses every 6 months. This cholera vaccine does not prevent transmission of infection. It is not recommended by the World Health Organization (WHO) or the DoD.

6. *Clostridium perfringens* Toxins.

A. Characteristics. *Clostridium perfringens* is a common anaerobic bacterium associated with three distinct disease syndromes; gas gangrene or clostridial myonecrosis; enteritis necroticans (pig-bel); and clostridial food poisoning. Each of these syndromes has very specific requirements for delivering inocula of *C. perfringens* to specific sites to induce disease, and it is difficult to imagine a general scenario in which the spores or vegetative organisms could be used as a biological warfare agent. There are, however, at least 12 protein toxins from *Clostridium* species, and one or more of these could be produced, concentrated, and used as a weapon. The alpha toxin, a well-characterized, highly toxic phospholipase, would be lethal by aerosol. Other toxins from the organism might be co-weaponized to enhance effectiveness.

B. Clinical Features. The clinical picture of aerosolized *C. perfringens* alpha toxin would be expected to be that of a serious acute pulmonary insult. Absorbed alpha toxin could produce vascular leakage, hemolysis, thrombocytopenia, and liver damage. Other toxins admixed could modify the illness.

C. Vaccine. There is no available prophylaxis against most *C. perfringens* toxins. Toxoids are being used to prevent enteritis necroticans in humans, and veterinary toxoids are in wide use.

7. Crimean-Congo Hemorrhagic Fever.

A. Characteristics. Crimean-Congo hemorrhagic fever (CCHF) is a viral disease caused by CCHF virus. The virus is usually transmitted by ticks, principally of the genus *Hyalomma*, with intermediate vertebrate hosts varying with the tick species. The disease was first recognized in the Crimea, but occurs over most of Africa, the Middle East, the Balkans, the former USSR, and eastern China. Humans become infected through tick bites, crushing an infected tick, or at the slaughter of viremic livestock. Even in epidemics, cases do not show narrow clustering and person-to-person spread is rare. CCHF would probably be delivered by aerosol if used as a BW agent.

B. Clinical Features. Typical cases present with sudden onset of fever and chills 3-12 days after tick exposure. Flushing, conjunctival injection, and mild hypotension may be present. After 2-3 days, perhaps with a temporary remission of fever, patients develop bleeding manifestations such as petechiae, ecchymoses, oozing from puncture sites, melena, hematuria, and gastrointestinal (GI) hemorrhage. Crimean-Congo hemorrhagic fever may cause quite severe ecchymoses and extensive GI bleeding. There is severe headache, lumbar pain, nausea and vomiting, delirium, and prostration. The sensitivity of the virus to ribavirin, and the severity of disease, suggests that prophylaxis of high-risk exposures is indicated.

C. Prophylaxis. Ribavirin is a synthetic, water soluble, colorless nucleoside available as an injectable solution for IV administration or in a capsule form for oral administration. Oral and intravenous ribavirin are IND products and would be available only on protocol with informed consent. Ribavirin was approved for use in Operation Desert Shield/Storm, Somalia and Korea. Monitoring for anemia is suggested. In the case of a suspected biological attack, ribavirin could be considered for therapy as well as prophylaxis.

8. Glanders.

A. Characteristics. The causative agent of Glanders is *Burkholderia* (formerly *Pseudomonas*) *mallei*, a gram-negative bacillus. Glanders is a highly communicable disease of horses, donkeys, and mules.

Epidemics of human glanders have not been reported. However, sporadic cases occur in Asia, Africa, the Middle East, and South America. Human infection occurs rarely and sporadically, and almost exclusively in those whose occupations involve contact with animals or work in laboratories.

This organism spreads to humans by invading the nasal, oral, and conjunctival mucous membranes, by inhalation into the lungs, and by invading abraded or lacerated skin. Aerosols from cultures have been observed to be highly infectious to laboratory workers. Since aerosol spread is efficient and no vaccine is available, *B. mallei* has been viewed as a potential biological warfare agent.

B. Clinical Features. Incubation period ranges from 10-14 days after inhalation. Inhalation exposure produces fever, rigors, sweating, myalgia, headache, pleuritic chest pain, cervical adenopathy, splenomegaly, and generalized papular/pustular eruptions. This disease is almost always fatal without treatment.

C. Vaccine. There are no means of immunization. Vigorous cleansing of abrasions and lacerations may reduce the risk of disease after inoculation of organisms into the skin.

9. Plague (*Yersinia pestis*).

A. Characteristics. Plague is a zoonotic disease caused by *Yersinia pestis*. Under natural conditions, humans become infected as a result of contact with rodents and their fleas. Transmission of this gram-negative coccobacillus is by the bite of an infected flea. Under natural conditions, three syndromes are recognized: bubonic, primary septicemic, or pneumonic plague. In a biological warfare scenario, the plague bacillus could be delivered via contaminated vectors (fleas) causing the bubonic type or, more likely, via aerosol causing the pneumonic type. In bubonic plague, the incubation period ranges from 2 to 10 days.

B. Clinical Features. The onset is acute and often fulminant with malaise, high fever, and one or more tender lymph nodes. Inguinal lymphadenitis (bubo) predominates, but cervical and axillary lymph nodes can also be involved. The involved nodes are tender, fluctuant, and necrotic. Bubonic plague may progress spontaneously to the septicemic form with organisms spreading to the central nervous system, lungs (producing pneumonic disease), and elsewhere. Mortality is 50 percent in untreated patients with the terminal event being circulatory collapse, hemorrhage, and peripheral thrombosis. In primary pneumonic plague, the incubation period is 2 to 3 days. The onset is acute and fulminant with malaise, high fever, chills, headache, myalgia, cough with production of a bloody sputum, and toxemia. The pneumonia progresses rapidly, resulting in dyspnea, stridor, and cyanosis. In untreated patients, the mortality is 100 percent with the terminal event being respiratory failure, circulatory collapse, and a bleeding diathesis.

C. Vaccine. A formalin-inactivated (licensed) *Y. pestis* vaccine is produced in the United States and has been extensively used. Live-attenuated vaccines are available elsewhere, but are highly reactogenic and without proven efficacy against aerosol challenge. The current plague vaccine does not reliably protect laboratory animals from aerosol challenge and would not be an effective BW countermeasure versus aerosol attack. Chemoprophylaxis is recommended for contacts of pneumonic plague patients. Post-exposure prophylaxis with either doxycycline or tetracycline has been recommended in known exposures. The addition of ceftriaxone is recommended for plague meningitis.

10. Q Fever.

A. Characteristics. Q fever is a zoonotic disease caused by the rickettsia, *Coxiella burnetii*. The most common animal reservoirs are sheep, cattle, and goats. Humans acquire the disease by inhalation of particles contaminated with the organism. A biological warfare attack would cause disease similar to that occurring naturally.

B. Clinical Features. Following an incubation period of 10-20 days, Q fever generally occurs as a self-limiting febrile illness lasting 2 days to 2 weeks. Pneumonia occurs frequently, usually manifested only by an abnormal chest radiograph. A nonproductive cough and pleuritic chest pain occur in about one-fourth of patients with Q fever pneumonia. Patients usually recover uneventfully.

C. Vaccine. A formalin-inactivated whole cell vaccine is available for immunization of at-risk personnel on an investigational basis. Vaccination with a single dose of this killed suspension of *C. burnetii* provides complete protection against naturally occurring Q fever and greater than 95% protection against aerosol exposure. Protection lasts for at least 5 years. Administration of this vaccine in immune individuals may cause severe cutaneous reactions including necrosis at the inoculation site. Treatment with tetracycline during the incubation period will delay but not prevent the onset of illness.

11. Ricin.

A. Characteristics. Ricin is a glycoprotein toxin from the seed of the castor bean plant. Altering ribosomal RNA blocks protein synthesis, thereby killing infected cells. Ricin's significance as a potential biological warfare agent relates to its availability worldwide, ease of production, and extreme pulmonary toxicity when inhaled.

B. Clinical Features. Overall, the clinical picture seen depends on the route of exposure. All reported serious or fatal cases of castor bean ingestion have taken approximately the same course: rapid onset of nausea, vomiting, abdominal cramps and severe diarrhea with vascular collapse. Death usually occurs on the third day or later after exposure. Following inhalation, one might expect nonspecific symptoms of weakness, fever, cough, and hypothermia followed by hypotension and cardiovascular collapse. In monkeys, inhalation toxicity is characterized by a dose dependent preclinical period of 24-36 hours followed by anorexia and progressive decrease in physical activity. Death occurs 36-48 hours post challenge. High doses by inhalation appear to produce severe enough pulmonary damage to cause death.

C. Prophylaxis. There is currently no prophylaxis approved for human use. Ricin is not dermally active; therefore, respiratory protection is the most critical means of prevention (similar to chemical agent exposure). Vaccines under development are immunogenic and confer protection against lethal aerosol exposures in animals.

12. Rift Valley Fever.

A. Characteristics. Rift Valley Fever (RVF) is a viral disease caused by the Rift Valley Fever (RVF) virus. The virus circulates in sub-Saharan Africa as a mosquito-borne agent. Epizootics occur when susceptible domestic animals are infected, and subsequent amplification of infection due to the large amounts of virus in animal serum. Deaths and abortions among susceptible species, such as cattle and sheep, provide a diagnostic clue and a method of surveillance. Humans become infected by the bite of mosquitoes, or by exposure to virus-laden aerosols or droplets. Outbreaks are typically associated with very high densities of arthropod vector populations that may occur during heavy and prolonged rains or in association with irrigation projects. Humans are also commonly infected when butchering sick and dead animals. The human disease appears to be similar whether acquired by aerosol or by mosquito bite. A biological warfare attack, most likely delivered by aerosol, would be expected to elicit a rather specific spectrum of human clinical manifestations and to cause disease in sheep and cattle in the exposed area. If disease occurred in the absence of heavy vector populations or without domestic animals as amplifiers of mosquito infection, a BW attack would be the likely cause of an outbreak. Domestic animals are probably susceptible to aerosol infection, or could be covertly infected, to initiate an epidemic that might propagate itself by the usual (natural) means.

B. Clinical Features. The incubation is two to five days and is usually followed by an incapacitating febrile illness of similar duration. The typical physical findings are fever, conjunctival injection, and sometimes-abdominal tenderness. A few petechiae or epistaxis may occur. A small proportion of cases will progress to a viral hemorrhagic fever syndrome, often with associated hepatitis. These cases may manifest petechiae, mucosal bleeding, icterus, anuria, and shock. Mortality in this group is roughly 50 percent. A similar proportion will develop clinically significant ocular changes such as macular lesions associated with retinal vasculitis, hemorrhage, edema, and infarction. After apparent recovery from a typical febrile illness, the patient develops fever, meningeal signs, obtundation, and focal defects. These patients may die or often have serious sequelae. Avoidance of mosquitoes and contact with fresh blood from dead domestic animals and respiratory protection from small particle aerosols are the mainstays of prevention.

C. Prophylaxis/Vaccine. An effective inactivated vaccine is available in limited quantities. Protective antibodies begin to appear within 10-14 days and last for a year. A single injection is probably not protective, but two inoculations may provide marginal short-term protection. Ribavirin prophylaxis of the related sandfly fever virus was successful, but the dose used might be expected to produce anemia and other effects in some recipients.

13. Saxitoxin.

A. Characteristics. Saxitoxin is the parent compound of a family of chemically related neurotoxins. In nature these toxins are predominantly produced by marine dinoflagellates. Human intoxications are principally due to ingestion of bivalve mollusks, which have accumulated dinoflagellates during filter feeding. The resulting intoxication, known as paralytic shellfish poisoning (PSP), is known throughout the world as a severe, life-threatening illness requiring immediate medical intervention. Saxitoxin and its derivatives are water-soluble compounds that bind to the voltage-sensitive sodium channel, blocking propagation of nerve-muscle action potentials. The natural route of exposure to these toxins is oral. In a BW scenario, the most likely route of delivery is by inhalation or toxic projectile. In addition, saxitoxin could be used in a confined area to contaminate water supplies.

B. Clinical Features. Consistent with the expected mechanism of action, victims typically present with neurological symptoms, and in severe cases, death results from respiratory paralysis. After oral exposure, absorption of toxins from the gastrointestinal tract is rapid. Onset of symptoms typically begins 10-60 minutes after exposure, but may be delayed several hours depending on the dose and individual idiosyncrasies. Initial symptoms are numbness or tingling of the lips, tongue and fingertips, followed by numbness of the neck and extremities and general muscular incoordination. Respiratory distress and flaccid muscular paralysis are the terminal stages that can occur 2-12 hours after intoxication. Death results from respiratory paralysis. Clearance of the toxin is rapid, and survivors for 12-24 hours will usually recover. Complete recovery may require 7-14 days.

C. Vaccine. No vaccine against saxitoxin exposure has been developed for human use.

14. Smallpox.

A. Characteristics. The smallpox virus is an orthopoxvirus with a narrow host range confined to humans. Eradication of the natural disease was completed in 1977. Appearance of human cases would signal use of the virus as a biological weapon. Under natural conditions, the virus is transmitted by direct contact with an infected case, by fomites, and occasionally by aerosols. Smallpox virus is highly stable and retains infectivity for long periods outside of the host. A related virus, monkeypox, clinically resembles smallpox and causes sporadic human disease in West and Central Africa. The incubation period is typically 12 days (range, 10-17 days).

B. Clinical Features. The illness begins with a prodrome lasting 2-3 days, with generalized malaise, fever, rigors, headache, and backache. This is followed by defervescence and the appearance of a typical skin eruption characterized by a 7-10 day progression of lesions, through successive stages, from macules to papules to vesicles to pustules. The latter finally form crusts and, upon healing, leave depressed depigmented scars. The distribution of lesions is centrifugal (more numerous on face and extremities than on the trunk). Lesions are in the same stage of development at any point in time. Fever may reappear around the 7th day after onset of rash. The case fatality rate is approximately 35% in unvaccinated individuals.

C. Patient Management. While smallpox patients were often cared for by immune care givers using standard (or no) precautions, the care of smallpox patients today would involve cohorting and quarantine in designated facilities, vaccination (to protect those possibly misdiagnosed), and the use of contact and, if possible, airborne precautions; respiratory droplet precautions might be the only feasible alternative in a mass casualty situation. All contacts including healthcare workers would be vaccinated and quarantined. Objects in contact with the patient (e.g. bed linens, clothing, ambulances) require disinfection by fire, steam, or sodium hypochlorite solution.

D. Vaccine/Prophylaxis. Smallpox vaccine (vaccinia virus) is a licensed live poxvirus vaccine that induces strong cross-protection against smallpox. Reliable data are sparse as to efficacy and durability of protection. The duration vaccinia induced immunity is at least 3 years. Vaccine immunity may prevent or modify illness. Fully immune individuals exposed to the virus by the respiratory route may develop fever, sore throat, and conjunctivitis ("contact fever") lasting several days. The vaccine is administered by dermal scarification or intradermal jet injection. The appearance of a vesicle or pustule within several days indicates that the vaccine will be effective. Other available countermeasures include the postexposure use of Vaccinia immune globulin or primary vaccination within 3-4 days of exposure yields some protection.

15. Staphylococcal Enterotoxin B.

A. Characteristics. Staphylococcal Enterotoxin B (SEB) is one of several exotoxins produced by *Staphylococcus aureus*, causing food poisoning when ingested. A BW attack with aerosol delivery of SEB to the respiratory tract produces a distinct syndrome causing significant morbidity and potential mortality.

B. Clinical Features. The disease begins 1-6 hours after exposure with a sudden onset of fever, chills, headache, myalgia, and nonproductive cough. In more severe cases, dyspnea and retrosternal chest pain may also be present. Fever, which may reach 103-106°F may last 2-5 days, but cough may persist 1-4 weeks. In many patients nausea, vomiting, and diarrhea will also occur. Physical findings are often unremarkable. Conjunctival injection may be present, and in the most severe cases, signs of pulmonary edema would be expected. In moderately severe laboratory exposures, lost duty time has been < 2 weeks, but, based upon animal data, it is anticipated that severe exposures will result in fatalities.

C. Prophylaxis. Currently there is no human vaccine for immunization against SEB intoxication. Experimental vaccines are under development. Passive immunotherapy can reduce mortality if given within 4-8 hours post SEB inhalation.

16. Trichothecene Mycotoxins (Yellow Rain).

A. Characteristics. The trichothecene mycotoxins are a diverse group of more than 40 compounds produced by fungi. The trichothecene (T-2) mycotoxins are the only toxin threats that penetrate skin or are that active on intact skin surfaces. They are potent inhibitors of protein synthesis, impair DNA synthesis, alter cell membrane structure and function, and inhibit mitochondrial respiration. Secondary metabolites of fungi, such as T-2 toxin and others, produce toxic reactions called mycotoxicoses upon inhalation or consumption of contaminated food products by humans or animals. Naturally occurring trichothecenes have been identified in agricultural products and have been implicated in a disease of animals known as moldy corn toxicosis (moldy corn poisoning). There are no well-documented cases of clinical exposure of humans to trichothecenes. However, circumstantial evidence has associated these toxins with alimentary toxic aleukia (ATA), the fatal epidemic seen in Russia during World War II, and with alleged BW incidents ("yellow rain") in Cambodia, Laos, and Afghanistan.

B. Clinical Features. Consumption of these mycotoxins results in weight loss, vomiting, skin inflammation, bloody diarrhea, diffuse hemorrhage, and possibly death. The onset of illness following acute exposure to T-2 (IV or inhalation) occurs in hours, resulting in the rapid onset of circulatory shock characterized by reduced cardiac output, arterial hypotension, lactic acidosis and death within 12 hours. Clinical signs and symptoms of ATA include hemorrhage, leukopenia, ulcerative pharyngitis, and depletion of bone marrow. The purported use of T-2 as a BW agent resulted in an acute exposure via inhalation and/or dermal routes, as well as oral exposure upon consumption of contaminated food products and water. Alleged victims reported painful skin lesions, lightheadedness, dyspnea, and a rapid onset of hemorrhage, incapacitation, and death. Ascorbic acid (400-1200 mg/kg, intra-peritoneal (IP) may decrease lethality.

C. Vaccine. There are no approved human vaccines for immunization against mycotoxins.

17. Tularemia (*Francisella tularensis*).

A. Characteristics. Tularemia is a zoonotic disease caused by *Francisella tularensis*, a gram-negative bacillus. Humans acquire the disease under natural conditions through inoculation of skin or mucous membranes with blood or tissue fluids of infected animals, or bites of infected deerflies, mosquitoes, or ticks. Less commonly, inhalation of contaminated dust, or ingestion of contaminated foods or water, may produce clinical disease. A BW attack with *F. tularensis* delivered by aerosol would primarily cause typhoidal tularemia, a syndrome expected to have a case fatality rate which may be higher than the 5-10% seen when the disease is acquired naturally.

B. Clinical Features. Under natural conditions, ulceroglandular tularemia generally occurs about 2 to 10 days after intradermal inoculation, and manifests as regional lymphadenopathy, fever, chills, headache, and malaise, with or without a cutaneous ulcer. Gastrointestinal tularemia occurs after drinking contaminated water, and is characterized by abdominal pain, nausea, vomiting, and diarrhea. Bacteremia probably is common after primary intradermal, respiratory or gastrointestinal infection with *F. tularensis* and may result in septicemic or "typhoidal" tularemia. The typhoidal form also may occur as a primary condition in 5-15% of naturally occurring cases. Clinical features include fever, prostration, and weight loss without adenopathy. Pneumonic tularemia is a severe, atypical, possibly fulminant, primary or secondary pneumonia. Primary pneumonia may follow direct inhalation of infectious aerosol, or may result from aspiration of organisms such as in cases of pharyngeal tularemia. Pneumonic tularemia causes fever, headache, malaise, substernal discomfort, and a non-productive cough. A biological warfare attack with *F. tularensis* would most likely be delivered by aerosol causing primarily typhoidal tularemia. Many exposed individuals would develop pneumonic tularemia (primary or secondary), but clinical pneumonia may be absent or non-evident. Case fatality rates may be higher than the 5-10% seen when the disease is acquired naturally.

C. Vaccine. A live, attenuated tularemia vaccine is available as an investigational new drug (IND). Its effectiveness in humans against the concentrated bacterial challenge expected in a BW attack is unproven.

18. Venezuelan Equine Encephalitis.

A. Characteristics. Eight serologically distinct viruses belonging to the Venezuelan equine encephalitis (VEE) complex have been associated with human disease. These agents also cause severe disease in horses, mules, and donkeys (Equidae). Natural infections are acquired by the bites of a wide variety of mosquitoes. Equidae serve as the viremic hosts and source of mosquito infection.

In natural human epidemics, severe and often fatal encephalitis in Equidae always precedes that in humans. A BW attack with virus disseminated as an aerosol would cause human disease as a primary event. If Equidae were present, disease in these animals would occur simultaneously with human disease instead of preceding it. Secondary spread by person-to-person contact occurs at a negligible rate. However, a BW attack in a region populated by Equidae and appropriate mosquito vectors could initiate an epidemic. Nearly 100% of those infected suffer an overt illness.

B. Clinical Features. After an incubation period of 1-5 days, onset of illness is extremely sudden, with generalized malaise, spiking fever, rigor, severe headache, photophobia, and myalgia of the legs and lumbosacral area. Nausea, vomiting, cough, sore throat, and diarrhea may follow. This acute phase lasts 24-72 hours. A prolonged period of asthenia and lethargy may follow, with full health and activity regained in 1-2 weeks. Neurologic cases are seen almost exclusively in children. The overall case-fatality rate is < 1%.

C. Prophylaxis/Vaccine. Investigational vaccines are currently being tested. An experimental vaccine, designated TC-83 is a live, attenuated cell-culture-propagated vaccine. A second investigational product that has been tested in humans is the C-84 vaccine, prepared by formalin-inactivation of the TC-83 strain.

5 CHEMICAL

Table of Contents

5.1.	Intelligence	5-2
5.2.	Chemical Contamination of food and water	5-8
5.3.	Chemical Decontamination	5-13
5.4.	Medical Planning Specific to Chemically Contaminated Areas	5-15
5.5.	Chemical Hazard Plotting	5-16
5.6.	Recognition of a Chemical Casualty	5-16
5.7.	Basic Chemistry	5-18
5.8.	Summary of the Effects and Physical Properties of Chemical Agents	5-19
5.9.	Nerve Agents	5-29
5.10.	Blister Agents (Vesicants)	5-33
5.11.	Blood Agents (Cyanogen Agents)	5-37
5.12.	Choking Agents (Lung-Damaging Agents)	5-38
5.13.	Incapacitating Agents	5-39
5.14.	Riot Control Agents	5-42
5.15.	Vomiting Agents	5-43
5.16.	Toxic Industrial Compounds (TICs)	5-44
5.17.	ACE Directive 80-64: NATO's Policy on Toxic Industrial Chemicals	5-46
5.18.	Smokes	5-51
5.19.	Flame Materials	5-53
5.20.	Hydrocarbon Fumes	5-53
5.21.	Herbicides	5-54

List of Tables

Table 5-A:	Types and Cases of Chemical Attacks	5-5
Table 5-B:	Casualty Estimate for Initial Chemical Hazards	5-7
Table 5-C:	ROTA Hazard Prediction Methods	5-7
Table 5-D:	Effect of Chemical Agents on Food	5-11
Table 5-E:	Effect of Certain Agents on the Appearance of Food	5-12
Table 5-F:	Disposition of Packaged and Stored Supplies	5-12

Table 5-G:	Maximum Allowable Concentrations of Agents in Drinking Water	5-12
Table 5-H:	Decontamination Levels	5-14
Table 5-I:	Decontaminants for Use with a Given Agent	5-15
Table 5-J:	Names and Symbols of Chemical Agents	5-20
Table 5-K:	Chemical Weapons Effects	5-20
Table 5-L:	Time of Onset of Symptoms from Chemical Agents	5-21
Table 5-M:	Persistence of Chemical Agents	5-21
Table 5-N:	Effects of Chemical Agents	5-22
Table 5-O:	Effects of Chemical Agents (continued)	5-23
Table 5-P:	Effects of Chemical Agents (continued)	5-24
Table 5-Q:	Effects of Chemical Agents (continued)	5-25
Table 5-R:	Physical Properties of Chemical Agents	5-27
Table 5-S:	Physical Properties of Chemical Agents (continued)	5-28
Table 5-T:	Time Course of Effects of Nerve Agents	5-31, 31
Table 5-U:	The Sequence of Skin Changes due to Mustard	5-35
Table 5-V:	Signs and Symptoms Produced by Incapacitating Agents	5-41
Table 5-W:	List of High Hazard TICs	5-45
Table 5-X:	Line items from the ACE Derivative 80-64	5-50

List of Figures

Figure 5-A:	Chemical Risk Assessment	5-6
Figure 5-B:	Chemical Marking System	5-8

5.1. Intelligence

- References: JP 3-11(Draft), FM 3-3, Chapter 5, International Air Transport Association-Dangerous Goods Regulations, and Reconnaissance of Industrial Hazards: Chemical, Biological, Radiological- Tactics, Techniques, and Procedures.
- Chemical Vulnerability Assessment. Vulnerability analysis is a systematic method for estimating friendly casualties and/or consequences from enemy or terrorist chemical attacks. The end state of vulnerability analysis is the recommendation to the commander on vulnerability reduction measures and to provide the information needed to make decisions concerning the acceptable level of risk in mission accomplishment.
- Dissemination and Deployment. Chemical strikes can be delivered with almost any type of conventional weapon system. Chemical rounds are less explosive than conventional rounds.

Means of delivery include, but are not limited to the following: Aircraft, Rocket, Bomblets, Shell, Spray, Bomb, Missiles, Unknown, Cannon, and Generator. Chemicals can also be delivered by non-traditional means through terrorist attacks such as the Tokyo subway incident. For hazard prediction, all attacks are classified as either Type A, air-contaminating agents or Type B, ground contaminating agents. The prediction of downwind chemical hazard areas depends on the wind speed, temperature, and humidity, and the size of the attack area.

4. Chemical Hazard Prediction.

A. General. The chemical hazard prediction procedure provides information on the likely location and the extent of the hazard area and the duration of the hazard resulting from attacks with chemical weapons. It provides the necessary information for commanders to warn units within the predicted hazard area. The prediction of the attack and hazard areas depends on the means of delivery, the type of attack, and the meteorological factors. There are two basic types of hazard prediction: those that rely on the “triangle” of NATO ATP-45 which merely tracks a “warning range,” and those that try to accurately map/predict the actual cloud (including deposition and re-evaporation). See Table 5-A.

B. Types of Chemical Attacks.

(1) Type A: Non-persistent agents, such as G-agents, create a vapor hazard.

(2) Type B: Persistent agents such as V-agents contaminate surfaces.

5. Releases Other Than Attack Hazard Prediction. These releases, referred to as Releases Other Than Attack (ROTA), may include, but are not limited to, toxic industrial chemical (TIC) or chemical releases due to damaged or destroyed storage bunkers, transport vehicles, storage or production facilities, ammunition supply sites, power plants, etc. Chemical material in any area of operation presents a hazard if released into the atmosphere either accidentally or intentionally. The amount of material released may be small or extremely large.

6. Recognition and Identification of Chemical Agent Contamination. Signs used for marking contaminated areas are standard throughout NATO in color and size. This permits easy identification. The color of the sign indicates the type of contamination. The primary or background color indicates the general type of hazard. The secondary color gives specifics as to what the hazard is. In addition to color, signs are standard size and shape. The sign is a right-angled isosceles triangle. The base is approximately 28 cm and the sides approximately 20 cm. The sign can be wood, plastic, metal, or any other available material. Place the signs with the point opposite the base of the triangle facing down. The U.S. marks contaminated areas with the NBC Contamination Marking Set. If units do not have this kit available, they can make the signs out of available wood or metal. These field expedient signs must be of standard shapes, sizes, and colors. See FM 3-3, chapter 5 for more information.

7. Recognition and identification of Toxic Industrial Chemicals (TIC).

A. Examples of Industries and their associated hazards. This section lists a few industrial settings and the representative types of hazards that may be found there. However, this list is not exhaustive, and each site must be treated as a separate problem depending on the details of the industrial activity that is carried out and the history of the site.

(1) Pharmaceutical Manufacturers can have a variety of reactive and toxic chemicals, physiologically active drugs, and possibly biological organisms.

- (2) Chemical Production or Manufacturing Facilities such as pesticide plants can have a number of reactive or toxic chemicals. A bulk manufacturing facility can have large storage tanks of hazardous chemicals, which may be transported in drums, pipelines, or tankers. A specialty chemical company may have similar quantities of a larger number of chemicals.
- (3) Fertilizer Manufacturing Facilities may have large quantities of inorganic solids, acids and bases, and gases.
- (4) Water/Sewage Treatment Plants can produce irritating or toxic gases. They may store large quantities of chlorine gas or hypochlorite.
- (5) Chemical Storage Facilities can contain large quantities of a variety of chemicals that should be in sealed containers.
- (6) Transportation/Shipping Facilities such as rail yard, depot, bulk storage area, or a maritime terminal can have a variety of chemicals or hazardous materials. The materials should be packaged, labeled, and sealed for safe shipment and may not be stored for a long time.
- (7) Petroleum Refineries can have large quantities of volatile, flammable, toxic compounds.
- (8) Government Research Facilities can be the source of a wide variety of hazards. Different facilities can specialize in nuclear, chemical, or biological research, or a combination of the three. In some cases, hazardous materials and wastes can be stored in large quantities.
- (9) Former Military Facilities should have been properly remediated to remove or destroy all hazardous materials. However, it may be possible that waste may have been buried or dumped without proper controls.
- (10) Military Firing Ranges/Proving grounds can be the location of buried or unexploded munitions or chemical weapons rounds. These munitions can be undocumented and are potentially very dangerous.
- (11) Industrial/Manufacturing Facilities can have large quantities of specialized chemicals, cryogenics, reagents, fuels, and manufacturing and transportation equipment. Industrial waste dumps may be located directly adjacent to, or in the vicinity of the manufacturing facility.
- (12) Conventional Power Generating Plants may have large storage facilities for flammable fuels, including coal, oil, or gas.
- (13) Landfills may generate irritating or noxious gases, which may be flammable or in extreme cases, explosive. Gases may accumulate in low lying areas to displace air.

B. Marking System. The United Nations Committee of Experts develops recommended procedures for the transport of all types of dangerous goods except radioactive materials. Included in these procedures are marking requirements of hazardous materials. Placards are used on large items such as trucks, pallets of hazardous materials, and storage areas. They are used to warn personnel at a distance of possible danger. (They serve as the "universal precautions" for the transporter.) Placards must conform to certain requirements on size, color, and strength. Each placard must be at least 273 mm on each side and must have a solid line inner border approximately 12.7 mm from each edge (See figure 5-B).

Table 5-A: Types and Cases of Chemical Attacks

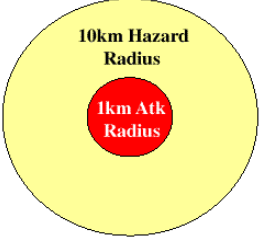
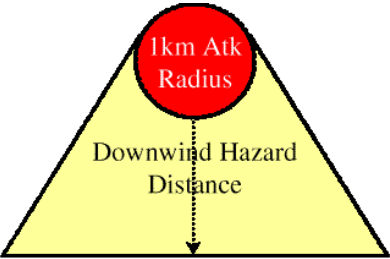
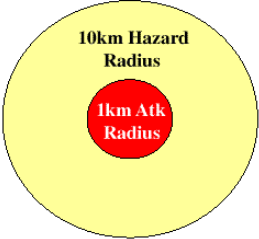
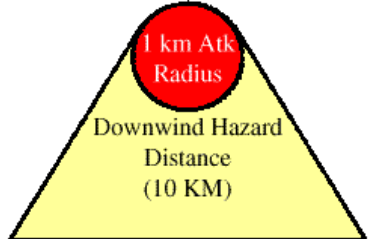
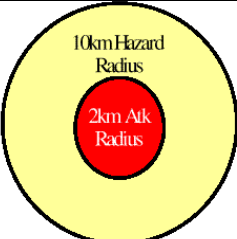
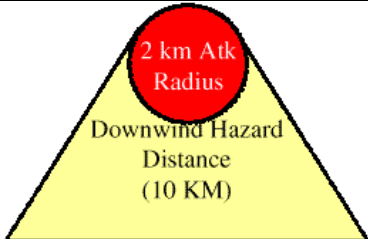
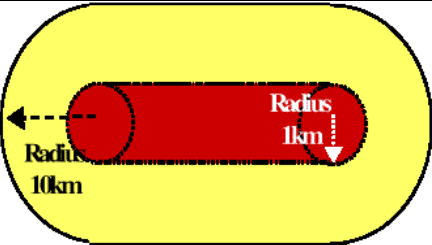
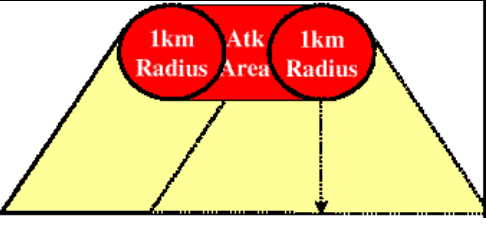
Means of Delivery	Radius of Attack Area	≤ 10 km/h	> 10 km/h
aircrafts, bomblets, multiple rocket launchers, bombs, cannons, shells, mortars, rockets, and surface burst missiles	≤ 1 km		
bomblets, cannons, shells, mortars, and surface burst rockets and missiles	≤ 1 km		
aircrafts, multiple rocket launchers, bombs, unknowns, and air burst rockets and missiles	> 1, ≤ 2 km		
sprayers, generators	> 2 km		

Reference: Table E-2-3 from Joint Pub 3-11 (Draft)

Figure 5-A: Chemical Risk Assessment

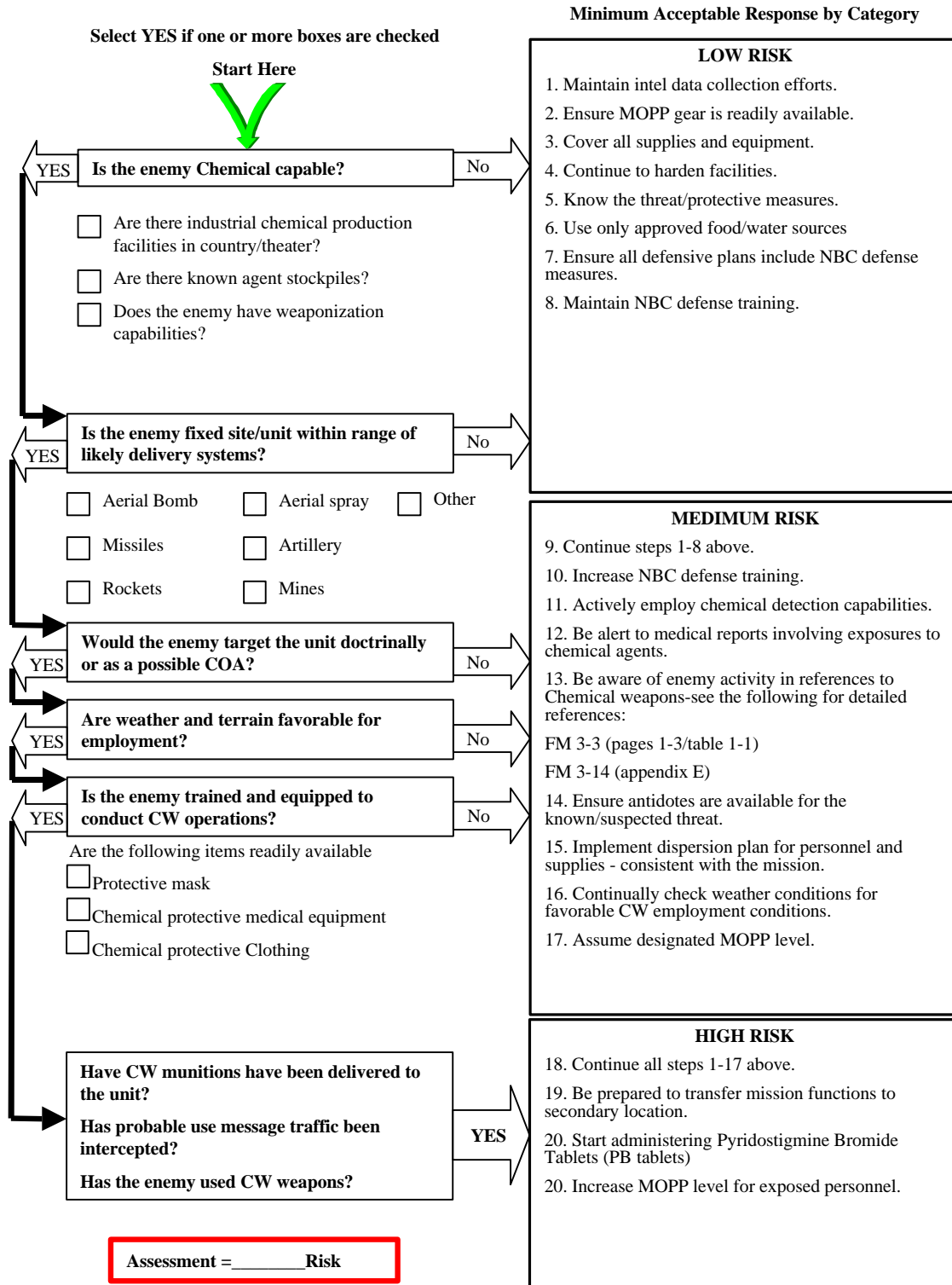

Reference: Figure I-7 from Joint Pub 3-11 (Draft)

Table 5-B: Casualty Estimate for Initial Chemical Hazards

Type Munitions	Target Radii (meters)	Percent Casualties*			
		Nonpersistent		Persistent	
		Nerve	Blood	Nerve	Blister
Bursting	150	40	10	25	10
	500	30	5	20	5
	1000	15	2	15	2
Spray	150			45	10
	500			30	5
	1000			20	2

*Troops in MOPP1 or MOPP2. For troops in MOPP4, reduce casualty percentages to a negligible level.

Reference: Table 1-3 from FM 3-7.

Table 5-C: ROTA Hazard Prediction Methods

Hazard Case	Prediction Procedure	Remarks				
		Chemical	Quantity (in Tons) UP TO	Day	Night	
Release from a bulk storage tank	If TIC is known and listed in this chart use exclusion areas shown	Phosgene	50	2 Km	5 Km	
		Hydrogen Cyanide (hot climate)				
		Hydrogen sulfide				
		Methyl isocyanate				
		Chlorine	100	1 Km	2.5 Km	
		Ammonia	500			
		Hydrogen Cyanide (cold climate)	50			
		Sulfur Trioxide				
		Nitrogen Tetroxide				
		Hydrogen Chloride				
		Bromine				
		Sulfur Dioxide				
		Acrlonitrile				
		Ammonia				100
If TIC is known but not listed, use these exclusion areas						1 Km
If TIC is unknown, use these exclusion areas			2 Km			5 Km

Reference: JP 3-11 (Draft).

Figure 5-B: Chemical Marking System

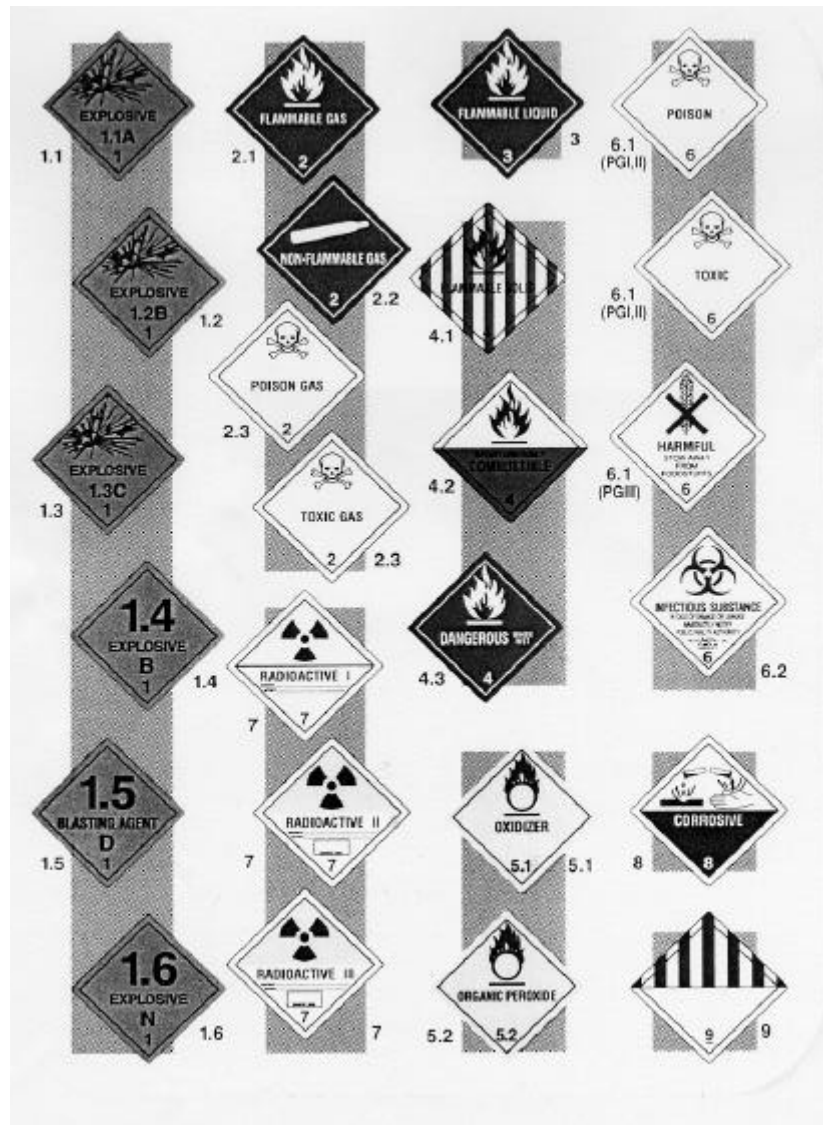

5.2. Chemical Contamination of food and water

1. Reference: TB Med 577 and FM 8-9, Part III.
2. The effects of chemical agents on food depend on the properties of both the agent and the food. Contamination of water may lead to a toxic hazard when it is used for food preparation.
3. Nerve and mustard agents readily penetrate fatty foods and will also penetrate granular foods (e.g., grain and sugar). Arsenicals penetrate proteins less readily owing to their coagulating action. Nerve agents may penetrate fruit. Three groups of foods may be considered on the basis of their composition.
 - A. Foods with high water content, but low fat and a crystalline structure (e.g., fresh vegetables, fruit, sugar, and salt). These absorb mustard and nerve agents in vapor and in liquid form.

- B. Foods with low fat content and amorphous structure (flour, bread, grain, rice cereals, dried fruit and vegetables, tea, coffee, peas and beans). These absorb liquid nerve and mustard agents; some absorption of vapor may occur.
- C. Foods with high fat and low water content (butter, fat, oil, ham, fat meat, cheese, milk, eggs, and fish). These absorb nerve agents and mustard so readily that decontamination is impossible.
4. Food may become highly toxic without any change in its appearance. The absence of these signs must not be relied upon in deciding that exposed food is fit.
 5. Effect of crops. Heavy contamination of plants with mustard or arsenicals will destroy crops. Lighter contamination may cause partial defoliation. Arsenical agents will leave sufficient arsenic to render the plant toxic, and nerve agents may penetrate plants so as to make them toxic.
 6. Effect on Livestock. The effects of chemical agents on livestock will be the same as those upon human casualties apart from species specific variations. Mustard does not cause blistering in animals. The presence of large numbers of dead animals may indicate contamination in the area and these animals should not be eaten.
 7. Packing Materials. Decontamination of food is difficult and not likely to be satisfactory, so that the protection of food and drink is of the first importance. Food supplies should therefore always be covered when transported or stored. Even the thinnest covering is better than no covering at all, but good protection can be given by suitable methods of packing and storing.
 8. Disposition of Packaged and Stored Supplies. In determining the disposition of packaged and stored supplies which have been contaminated, consideration must be given to the nature of the contaminant, as well as to the type of foodstuffs and the security afforded by the packaging material.
 9. Monitoring Food. All food exposed to chemical attack that has not been protected by agent-proof containers or in fully protected stores must be considered contaminated. Monitoring for volatile agents only may be undertaken by putting the food into a clean plastic bag and sampling the air in the bag with suitable detection equipment. Where arsenical contamination is suspected, the food may be suspended in water and the water tested with a water testing kit. Liquid contamination on the surface of containers may be tested for using detector papers, but this method will only be reliable while liquid agent remains. Mental incapacitants, biological agents, and nuclear fallout will not be detected by these means.
 10. Classification of Supplies. Before any decontamination is done, a careful survey should be made to determine the extent of the contamination. From information gained in this survey, the exposed items should be divided into three groups.
 - A. Group I will consist of canned and unopened packaged items that have been exposed only to the vapors of a chemical agent. Generally, the items in this group will be safe to issue to personnel after a brief period of outdoor airing.
 - B. Group II will consist of canned and unopened packaged items, the outsides of which have been contaminated with a liquid chemical agent. The best procedure is to allow self decontamination of the packaging material by ageing and airing. If a shortage of food does not permit the necessary time for self decontamination, then a decontamination procedure is to strip

off the outer contaminated coverings and examine the inner layer to see if agent penetration has occurred. If it has, continue stripping off layers until an uncontaminated layer is reached.

C. Group III will consist of unpackaged or poorly packaged items that have been exposed to an agent in either vapor or liquid form. Decontamination of food itself will be attempted only in emergency situations when there is no alternative supply of food. The general decontamination procedure to be followed in sequence is:

- (1) Trimming of surface fat and/or grossly contaminated areas.
- (2) Washing with water of 2% sodium bicarbonate solution or 1% chlorine solution.
- (3) Boiling in water. Frying, roasting or boiling will not remove traces of nerve or blister agents from meats. In general, salvage of foods contaminated with droplets of the blister agents is not practical.

11. Water. Contamination of water may lead to a toxic hazard when it is used for drinking, washing, and food preparation. Although many agents hydrolyse in water, this is not satisfactory as a method of decontamination. Arsenical agents leave degradation products that are toxic even when hydrolysis is complete. The appearance of water does not indicate contamination, and any water exposed to high concentrations of vapor, or any liquid contamination must be regarded as toxic until tests have been made. Open water sources subjected to chemical attack should be considered contaminated until tested. Water from deep wells will be safe provided that the well mouth is covered. Water in closed metal tanks will be safe provided that the tap and air inlets are decontaminated.
12. Monitoring Water. Water testing kits will detect the following agents: mustard, nerve agents (0.05 ppm only), arsenic, antimony, cyanogen agents, other heavy metals (lead, copper, mercury). Water with a pH less than 3 is condemned since this high acidity may be due to contamination with mustard, but if free chlorine is present throughout 30 minutes mustard will be destroyed. Chlorine in excess of 5 ppm will, however, interfere with the testing and should be reduced (e.g., with thiosulphate). The water testing kits will not detect mental incapacitants, biological agents, or nuclear fallout.
13. Decontamination of Water. Simple boiling is not a reliable method of decontamination. The following methods are available for decontaminating water and may be used in combination:
 - A. Filtration. In a small scale emergency, water may be decontaminated by running it through a spare unused respirator canister, provided that the flow rate is such that the water emerges drop by drop; any water coming through at first faster than this should be discarded. No more than 5 liters should be filtered with one canister. The canister cannot be used on a respirator after being used for this purpose.
 - B. Superchlorination. Small amounts of water, in units of one litre, may be superchlorinated. Simple chlorination, as is used to disinfect water from naturally occurring bacterial contaminants, is not sufficient to decontaminate water suspected of being contaminated with chemical agents.
 - C. Flocculation. Larger quantities of water may be treated by flocculation with metal salts, after which the water is treated with chlorine.
 - D. Reverse Osmosis. Reverse osmosis is an effective method of removing contamination, including heavy metals.

Table 5-D: Effect of Chemical Agents on Food

Type of agent	High fat content (butter, fats, cheese, meat, bacon, and shell eggs, etc.)	Low fat, high moisture content (fruit, vegetables, sugar, salt, etc.)	Low fat, low moisture content (cereal, tea, coffee, flour, bread, rice, etc.)
Nerve agents (liquid)	Condemn	Condemn	Condemn
Nerve agents (vapor)	Condemn	Expose dry food to the air for 48 hours. Wash other foods with 2% sodium bicarbonate solution, peel where applicable, and cook by boiling.	Expose dry food to the air for 48 hours. Wash other foods with 2% sodium bicarbonate solution, peel where applicable, and cook by boiling.
Blister agents (liquid)	Condemn	Condemn	Condemn
Blister agents (vapor)	Condemn	Expose dry food to the air for 48 hours. Wash other foods with 2% sodium bicarbonate solution, peel where applicable, and cook by boiling.	Expose dry food to the air for 48 hours. Wash other foods with 2% sodium bicarbonate solution, peel where applicable, and cook by boiling.
Choking agents *	Wash food with water where possible and expose to the air for 24 hours. Food may be unpalatable due to the acid product of hydrolysis.	Wash food with water where possible and expose to the air for 24 hours. Food may be unpalatable due to the acid product of hydrolysis.	Wash food with water where possible and expose to the air for 24 hours. Food may be unpalatable due to the acid product of hydrolysis.
Cyanide type agents	Unlikely to produce dangerous contamination of foodstuffs.	Unlikely to produce dangerous contamination of foodstuffs.	Unlikely to produce dangerous contamination of foodstuffs.
Riot control agents	Food may be unpalatable to the extent of being inedible.	Food may be unpalatable to the extent of being inedible.	Food may be unpalatable to the extent of being inedible.
* Agents decomposed rapidly on contact with water.			

Reference: Table 12-II from FM8-9, Part III.

Table 5-E: Effect of Certain Agents on the Appearance of Food

Agent	Taste	Smell	Color
Mustard	Affected	Garlic	Meat discolored
N-Mustard	Affected	Fishy	No discoloration
Arsenicals	Acid	Unpleasant	Meat & vegetables discolored
Nerve agents	None	None	No effect
White phosphorus	Acid	Garlic	Glow in dark

Food may become highly toxic without any changes in its appearance. The absence of these signs must not be relied upon in deciding that exposed food is fit for consumption.

Reference: Table 12-I from FM 8-9, Part III

Table 5-F: Disposition of Packaged and Stored Supplies

Airtight glass bottles, sealed aluminum laminated packages, and sealed metal cans give complete protection against vapor and liquid. Decon outer surface before opening.
Wooden boxes not sealed for the exclusion of air gives almost no protection against vapor and liquid.
Waxed paper boxes sealed for the exclusion of air give good protection against vapor and fair protection against liquid.
Untreated wrapping papers give poor protection against vapor and very little against liquid.
Ordinary textiles in a single layer packaging give almost no protection against vapor and liquid.
Coverings of sod and earth give good protection against vapor and liquid.
Overhead shelters give protection against liquid sprays and splashes. Closed buildings give protection against liquids but often not against vapors, unless overpressured with filtered air.
Generally, double layers greatly increase the protective efficiency of packaging materials.
Field rations are packaged to protect the enclosed foods for hours even when the outside of the package is heavily contaminated with a liquid agent.

Table 5-G: Maximum Allowable Concentrations of Agents in Drinking Water

Agent	Maximum Allowable Concentration (mg/l) consumed at 5 liters per day for not more than 7 days
GA	0.014
GB	0.028
GD	0.012
VX	0.015
Mustard	0.140
Arsenic	0.3
Cyanogens	6.0

Reference: TB Med 577 and Table 12-III of FM 8-9 (Part III).

5.3. Chemical Decontamination

1. References: FM 3-7, FM 3-5, FM 8-285, and FM 8-9.
2. Nerve Agents- Decontamination of patients. The importance of early decontamination can not be over emphasized. Decontamination of the skin should be accomplished quickly if it is to be fully effective. Liquid agent may be removed by fullers' earth or chemically inactivated by the use of reactive decontaminants. Decontamination personnel should wear a mask and protective equipment while decontamination is performed. Once a casualty has been decontaminated, or the agent fully removed, no further risk of contamination exists. The casualty's body fluids, urine, or feces do not present a chemical warfare (CW) hazard.
3. Decontamination of Vesicants.
 - A. Decontamination of Mucous Membranes and Eyes. The affected tissues should be flushed immediately with water from the water bottle (canteen). The eyes can be flushed with copious amounts of water, or, if available, isotonic sodium bicarbonate (1.26%) or saline (0.9%).
 - B. Decontamination of the Skin. Each soldier is given the means for preliminary decontamination of the skin, the means being based on physical adsorption or on the combination of physical adsorption and chemical inactivation. Physical adsorption can be achieved by adsorbing powders. Chemical inactivation is often effected by chlorinating compounds incorporated into adsorbing powders, ointments, solutions, or organic solvents. **Mustards should not be decontaminated with water**, except for the eyes, as this may spread the agent.
 - C. Additional Procedures. Whatever means is used has to be efficient and quick acting. Within 2 minutes contact time, a drop of mustard on the skin can cause serious damage. Chemical inactivation using chlorination is effective against mustard and Lewisite, less so against HN3, and is ineffective against phosgene oxime. In the case of thickened mustard, where the usual procedure is inadequate, the agent may be scraped off with a knife or similar hard object, taking care not to spread the agent or abrade the skin. This may be followed by wetting the surface with a cloth drenched in an organic solvent, e.g., petrol (unleaded gasoline) and subsequent application of the usual decontaminating procedure. If water is available in abundant amounts, copious washing should follow these procedures.
 - D. Decontamination of Wounds. Mustard may be carried into wounds on fragments of cloth. These wounds should be carefully explored using a no-touch technique. Fragments of cloth should be removed and placed in a bleach solution. This removes the hazard from mustard vapor off-gassing. Wounds should be irrigated using a solution containing 3000-5000 ppm (parts per million) free chlorine (dilute "milton" solution) with a dwell time of approximately 2 minutes. The wound should then be irrigated with saline. Irrigation of the contaminated wound should not be used in the abdominal, or thoracic cavities, or with intracranial head injuries.
 - E. Decontamination for Lewisite is the same as for mustard.
 - F. Chemical inactivation using alkalis is effective, whereas chlorinating is ineffective against phosgene oxide. The eyes should be flushed immediately using water or isotonic sodium bicarbonate solution if available. Physical decontamination of the skin using adsorbent powders, e.g., fullers' earth, is advised.

4. Hydrogen Cyanide Decontamination. Because of its physical properties, hydrogen cyanide will not remain for long in its liquid state. Decontamination should not, therefore, be necessary. The same is true of cyanogen chloride and cyanogen bromide.
5. Choking Agents Decontamination. Because of its physical and chemical properties, the agent will not remain in its liquid form for long, and decontamination is not required except when it is used in very cold climates.
6. Incapacitating Agents Decontamination. Complete cleansing of the skin with soap and water should be accomplished at the earliest opportunity. Symptoms may appear as late as 36 hours after percutaneous exposure, even if the skin is washed within an hour. In fact, a delay in onset of several hours is typical. This time should be used to prepare for the possibility of an epidemic outbreak 6 to 24 hours after the attack.
7. Riot Control Agents Decontamination. Exposed persons should if possible move to fresh air, separate from fellow sufferers, face into the wind with eyes open and breathe deeply. Following exposure, clothing and individual equipment should be inspected for residue. If a residue is found, individuals should change and wash their clothing to protect themselves and other unmasked persons.
8. Vomiting Agents Decontamination. The eyes and skin may be washed with water. Clothing should be well brushed.

Table 5-H: Decontamination Levels

Level	Technique	Best Start Time	Done by	Gains
Immediate	Skin Decon	Before 1 minute	Individual	Stops agent from penetrating
	Personal Wipe down	Within 15 minutes	Individual or crew	
	Operator Spray down			
Operational	MOPP Gear Exchange	Within 6 hours	Unit	Possible temporary relief from MOPP4.
	Vehicle Wash down		Battalion Crew or decon platoon	Limit liquid agent spread.
Thorough	Detailed Equipment/Aircraft Decon	When mission allows reconstitution	Decon platoon	Probable long-term MOPP reduction with minimum risk.
	Detailed Troop Decon		Unit	

*The techniques become increasingly less effective the longer they are delayed.

**Performance degradation need to be considered when exceeding 6 hours. See FM 3-4.

***Vehicle wash down is most effective within 1 hour, but will often have to be delayed for logistical reasons.

Reference: Table 3-31 of FM 3-7.

Table 5-I: Decontaminants for Use with a Given Agent

Nerve Agents	STB slurry; household bleach, 10% solution of lye or washing soda; DS2; steam and ammonia in confined area; hot, soapy water; M258 series kit; M291.
Blood Agents	None needed in field.
Blister Agents	STB; DS2; household bleach; M258 series kit; Try lye; fire. Wash with soap and water.
Biological Toxins	Decontaminate toxins using soap and water, bleach, M258 series kits, STB, or DS 2.

Nonstandard decontaminants and decontamination of specific items are in FM 3-7.

5.4. Medical Planning Specific to Chemically Contaminated Areas

1. Reference: Chapter 11 of FM 8-9 (Part III).

2. Contamination Control.

A. One of the most difficult aspects of chemical warfare is that the chemical agents may persist in the environment for extended periods of time. This is especially true of agents such as VX, the mustards, thickened GB, or GD, which may remain as contact hazards for hours or days.

B. On the chemical battlefield, three types of environments may exist:

(1) Uncontaminated areas where there are no chemical agents present.

(2) A contaminated area where chemical agents are present in a liquid state (and probably in a vapor state as well) presenting a surface contact hazard.

(3) A vapor-only environment, for example, in a downwind hazard area.

C. Complete decontamination of a contaminated environment may be difficult or impossible. However it may be possible to achieve sufficient decontamination, particularly in small areas, to create a vapor only hazard area. Thus it may be possible to decontaminate equipment so that no further surface contact hazard exists, even though chemical agent vapors may continue to be off-gassed from agent adsorbed onto or absorbed into the surface. In such environments, it may be possible to work without the full protective clothing ensemble, although respiratory and eye protection would still be required. This is because most agents in a vapor state penetrate through the skin very slowly. However, mustard at high vapor concentrations may still cause skin injury, particularly if the skin surface is wet or moist, as may be the case in a warm environment.

D. Where a liquid hazard exists, decontamination of skin and eyes must be accomplished quickly if it is to be effective. Chemical agents may penetrate or react with the skin and eyes within minutes, so successful decontamination must be carried out immediately after exposure. Once agent is decontaminated, or has been absorbed, no further risk of contamination exists. The casualty's body fluids, urine, or feces do not constitute a CW hazard.

3. Combined Injuries. Combined injuries occur when a casualty is affected by conventional weaponry and also by the use of nuclear, chemical or biological weapons. The situation in which a casualty is contaminated with a chemical agent, but not suffering from such an agent's effects is dealt with in AMedP-7 (B). Wounds that are not contaminated should be dressed in the usual way. They should then be covered with agent proof material (either impervious material or

material similar to that of the protective suit) and any pressure bandage considered necessary may then be applied over the protective covering. These precautions may prevent the casualty becoming a mixed chemical and conventional casualty. Additional information concerning chemical and conventional combined injuries is found in Chapter 11 of FM 8-9 (Part III).

5.5. Chemical Hazard Plotting

See Chapter 2 of FM 3-7 for flow charts on how to plot chemical attacks.

5.6. Recognition of a Chemical Casualty

1. Reference: FM 8-9 (Part III). Chapter 11 of FM 8-9 details the nine phases of casualty care.
2. General. Medical units should rely on information not only from detectors and intelligence sources but also from the casualties themselves. This applies particularly to agents for which at present there is no satisfactory detector, such as incapacitating agents. Some of the problems in the recognition and diagnosis of casualties suffering from the effects of chemical operations are discussed here. Medical personnel must bear in mind that with nerve agents, for example, symptoms and signs may range from mild, such as miosis, headache, and tightness of the chest to signs and symptoms associated with severe poisoning such as convulsions and respiratory failure. The nature and timing of symptoms will vary with the route of exposure. Although choking agents are less likely to be employed, the possibility of their use should not be forgotten, and here the danger is that the quiescent period which follows the initial poisoning might be mistaken for recovery and men or women sent back to duty even after a lethal dose. Battle casualties whose behavioral changes are not compatible with the physical signs of disability must be examined carefully to exclude the possibility of a psychomimetic agent having been used. When the enemy has used chemical agents, it is important that the fullest and earliest information be given to medical units to facilitate the diagnosis of individual cases and to permit the arrangements for the reception of casualties.
3. Recognition of a Casualty of Chemical Operations. Any individual who suddenly becomes a casualty without being wounded or who is suffering a greater degree of incapacitation than is compatible with his or her wound should be considered a possible chemical casualty. The differential diagnosis will include the possibility of psychiatric casualties. It is unlikely that chemical agents would produce single casualties under field conditions and a chemical attack should be suspected with any sudden increase in numbers of unexplained casualties. If chemical operations are unlikely, and if only a few people are affected, another toxic hazard may be more probable (for example, carbon monoxide).
4. Questioning Casualties. Under operational conditions the medical situation may be complicated by the psychological effects. The medical officer's questions should be along the following lines:
 - A. Determine whether the casualty has been caused by a chemical agent:
 - (1) Was the casualty wearing full protective equipment at the time of the attack?
 - (2) Were there any aircraft or artillery bombardments in the area at the time of the attack?
 - (3) Was there any evidence of spray, liquid droplets, or smoke?
 - (4) Was anybody else affected and if so, how was he or she affected?

(5) Did the casualty notice any unusual smell? (This is not a very reliable symptom under battle conditions, but it should be considered.)

(6) Did the available detection equipment respond positively?

B. Determine the identity of the agent:

(1) What subjective effects were noticed and how soon?

(a) An unexplained sudden runny nose.

(b) A feeling of choking or tightness in the chest or throat.

(c) Blurring of vision and difficulty in focusing the eyes on close objects.

(d) Irritation of the eyes.

(e) Unexplained difficulty in breathing or increased rate of breathing.

(f) Sudden feeling of depression.

(g) Anxiety or restlessness.

(h) Dizziness or light-headedness.

(i) Slurred speech.

(j) Nausea.

(k) Muscular weakness.

(2) Was there any delay between exposure or contamination and the onset of effects, and if so, for how long?

(3) Did the effects persist after adjustment of the protective mask?

(4) Has the casualty used any self-injection device? If so, did the symptoms improve or deteriorate?

(5) Is the casualty's behavior normal?

C. Assess the dose of agent received:

(1) Was the casualty exercising or at rest?

(2) Was the casualty in the open or under cover?

(3) For how long was the agent inhaled? How long was the interval between suspected contamination and decontamination?

5. Types of Casualties. On the chemical battlefield, the following types of casualties may be seen:

A. Conventional Casualties.

(1) The conventional casualties with no chemical injury and with no contamination of their clothing and equipment.

(2) The conventional casualties with no chemical injury but with contamination of their clothing and equipment.

B. Direct Chemical Casualties.

(1) The chemical casualty with no other injury.

(2) The mixed casualty who has a conventional and chemical injury. Since chemical munitions often include explosive burst charges, such injuries may occur as part of a chemical agent attack. They may also occur when the chemical injury and conventional injury occur at

different times. Other types of mixed casualties may occur if nuclear or biological weapons are used, and chemical injuries may occur combined with natural illness as well.

C. Indirect Chemical Casualties.

(1) Casualties suffering combat stress reaction (CSR). Combat stress reaction occurs often in warfare, but may be more frequent where the chemical warfare threat exists. The soldier will have additional stresses of isolation from wearing the chemical protective ensemble, additional fatigue from wearing the garments and fear of chemical agents. Diagnosis between the CSR casualties and chemical casualties may sometimes be difficult.

(2) Casualties with side effects from chemical agent antidotes. Some of the available antidotes may have undesirable side effects when taken inappropriately, or in large enough quantities. Atropine, for instance, causes decreased heat tolerance at a dose of 1 mg. Higher doses may cause tachycardia, dryness of the mouth, and decreased sweating. Medical personnel must be aware of the side effects of the available antidotes and be alert for their appearance.

(3) Heat casualty. Wearing the protective ensemble makes dissipation of excess body heat more difficult. Wearing the mask also makes water intake very difficult.

5.7. Basic Chemistry

1. References: FM 3-7, FM 3-9, FM 8-9, Part III, FM 8-10-7, FM 8-285, TC 3-10, USAMRICD's *Field Management of Chemical Casualties*, and USACHPPM's TG 218. See FM 8-285 for treatment procedures and TG 218 for detail information about chemical agents.
2. Exposure. Chemical agents may enter the body by several routes and the nature and onset of signs and symptoms may vary accordingly. The agents can be disseminated as a vapor or aerosol under ambient conditions. Vapor and aerosol chemical agents often enter the body through the respiratory tract (inhalation injury). The agent may be absorbed by any part of the respiratory tract from the mucosa of the nose and mouth to the alveoli of the lungs. Vapors and droplets of liquids can be absorbed from the surface of the skin and mucous membranes. Toxic compounds that are harmful to the skin can produce their effects in liquid or solid state. Agents penetrating the skin may form temporary reservoirs under the skin; the vapors of some volatile liquids can penetrate the skin and cause adverse effects.
3. Persistence. Chemical agents may be divided into two main categories that describe how long they are capable of producing casualties: persistent and nonpersistent. Chapter 3 from FM 3-7 has 12 charts of unmasking times for various agents in different situations.
 - A. **Persistent** agents continue to present a hazard for considerable periods (days) after delivery by remaining as a contact hazard, or by slowly vaporizing to produce a hazard by inhalation.
 - B. **Nonpersistent** agents disperse rapidly after release and present an immediate, short duration (hours) hazard. They are released as airborne particles, aerosols, and vapors.
4. Meteorological. The following meteorological factors will influence the duration of effectiveness of chemical agents:

A. Wind. The effect of wind is to disperse agents rapidly in open country. However, dangerous concentrations may remain longer in protected areas such as woods, trenches, dug-outs and built-up areas.

B. Temperature. High temperatures decrease the persistency of agents and tend to cause higher vapor concentrations. Low temperatures increase the persistency of agents. Some agents may freeze, thus reducing the immediate contact hazard or vapor hazard. There is a danger of carrying such frozen agents on clothing and equipment into a warm building with the subsequent risk of toxic vapor being given off.

C. Rain. Rain washes away, dilutes, and promotes hydrolysis of agents. This reduces their effectiveness but does not make them harmless.

D. Atmospheric Stability. When the upper air temperature is lower than that at ground level (a state of inversion), agents in the vapor state will persist for longer periods than when the upper air temperature is higher than that at ground level (a state of lapse).

5. Toxicity. The effectiveness of a chemical agent is a measure of how much agent is required to produce the desired effect. Thus, an agent that is toxic at a lower dose than another similar agent is more effective. The terminology used in this manual is as follows:

A. Dose. The dose is the quantity of the compound received by the subject. It is usually expressed as milligrams of agent per kilogram of subject body weight (mg/kg).

B. LC_{t50}. The LC_t (lethal concentration time)₅₀ is the Ct which will kill 50% of the exposed population. Also defined as the median lethal dosage of a chemical agent vapor or aerosol.

C. IC_{t50}. The IC_t (incapacitating concentration time)₅₀ is the Ct which will incapacitate 50% of the exposed population. Also defined as the median incapacitating dosage of a chemical agent vapor or aerosol.

6. Densities. Both the vapor and liquid densities of all chemical agents except AC are greater than that of air and water respectively.

5.8. Summary of the Effects and Physical Properties of Chemical Agents

1. References: Annex C of FM 8-9 (Part III), FM 8-10-7, 49 CFR, TC 3-10, and USACHPPM's TG 218.
2. See next several pages for the tables.

Table 5-J: Names and Symbols of Chemical Agents

Type	Common Name	Symbol	UN Code
Nerve Agents	Tabun	GA	UN 3278
	Sarin	GB	UN 3278
	Soman	GD	UN 3278
		GF	UN 3278
		VX	UN 3278
Vesicants or Blister Agents	Sulfur Mustard	H and HD	UN2810
	Sulfur Mustard-T Mixture	HT	UN2810
	Nitrogen Mustard	HN-1	UN2810
	Nitrogen Mustard	HN-2	UN2810
	Nitrogen Mustard	HN-3	UN2810
	Lewisite and other arsenical vesicants	L	UN 1556
	Mustard/Lewisite mixture	HL	UN 1556
	Phosgene oxime	CX	
Pulmonary Agents (Choking Agents)	Phosgene	CG	UN 1076
	Diphosgene	DP	
Blood Agents (Cyanide)	Hydrogen cyanide	AC	UN 1051
	Cyanogen chloride	CK	UN 1589
Vomiting Agents	Adamsite	DM	
	Diphenylchlorarsine	DA	
	Diphenylcyanarsine	DC	
Irritant agents (Tear agents)	Chloroacetophenone	CN	UN 1697
	Bromobenzylcyanide	CA	UN 1694
	Chloroacetophenone and Chloropicrin in Chloroform	CNS	UN 1693
	Chloropicrin	PS	UN 1580
	O-Chlorobenzylidene Malononitrile	CS	
	Dibenzoxazepine	CR	
Incapacitating agents	3-quinuclidinyl benzilate	BZ	
	D-Lysergic Acid Diethylamide	LSD	

Reference: Table C-I from FM 8-9 (Part III) and USACHPPM's TG 218.

Table 5-K: Chemical Weapons Effects

Chemical Agent	Target of Choice	Target Effect
Nonpersistent Nerve	Personnel	Immediate and lethal
Persistent Nerve	Terrain, material, combat service support, command and control facilities	Restrict use, cause casualties, strain logistics and command and control
Persistent Blister	Same as Persistent Nerve	Same as Persistent Nerve but not necessary lethal
Nonpersistent Blood and Choking	Personnel	Immediate, lethal or casualty producing

Reference: Table 1-4 from TC 3-10.

Table 5-L: Time of Onset of Symptoms from Chemical Agents

Symbol	Time of Onset of Symptoms (vapors)	Time of Onset of Symptoms (skin)
GA	Seconds to minutes	2 hours
GB	Seconds to minutes	2 hours
GD	Seconds to minutes	2 hours
GF	Seconds to minutes	up to 2 hours
VX	Minutes	up to 18 hours
V _x	Unknown	unknown
HD	4 to 6 hours	2-48 hours
HT		
HN-1		
HN-2		
HN-3		
L	Immediate	Immediate
HL		
CX		Immediate
CG	Immediate	N/A
AC	Seconds	N/A
CK	Immediate	N/A
DM	Several minutes	N/A
DA	Several minutes	N/A
DC	Several minutes	N/A
CN	Immediate	Immediate
CA		
PS	Immediate	Immediate
CS	Immediate	Immediate
CR	Immediate	Immediate
BZ	1 to 4 hours	N/A
LSD	Few minutes	N/A

Reference: Table C-I from FM 8-9 (Part III) and USACHPPM's TG 218.

Table 5-M: Persistence of Chemical Agents

Type of Agent	Symbol	Summer	Winter
Nerve	GA,GB,GD	10 min-24 hr	2 hr-3 days
	VX	2 days-1 wk	2 days-weeks
Choking	CG, DP	1 to 10 min	10 min-1 hr
Blister	HD, HN	3 days-1 wk	Weeks
	L, HL	1-3 days	Weeks
	CX	Days	Days
Blood	AC, CK	1-10 min	10 min-1 hr

Note: FM 3-6 details the persistence of the various chemical agents.

Reference: Table 2-10 from FM 8-10-7.

Table 5-N: Effects of Chemical Agents

Symbol	Mechanism of action	Treatment	Cardiovascular system
GA GB GD GF VX	Anticholinesterase agents.	Pre-treatment with pyridostigmine. Post-exposure therapy: Cholinergic blockage - atropine. Enzyme reactivation - oximes. Anticonvulsant – diazepam. Assisted ventilation. e. Suction for respiratory secretions.	Occasional early transient tachycardia and/or hypotension followed by bradycardia and hypotension.
H HD HN1, HN2, HN3	Vesicants. Bone marrow depressant. Alkylating agents, damages DNA.	Phenargen- for vomiting, itching, and edema. Eyes: antibiotics, cycloplegics and systemic analgesia or analgesics. Skin: local dressings and antibiotics for infection. Antibiotics for respiratory infection. IV fluids.	Shock after severe exposure.
L	Vesicants. Arsenical poisons.	Like sulfur and nitrogen mustards. BAL in oil IM for systemic chelation. BAL ointment for eyes and skin.	Shock after severe exposure. Hemolytic anemia, hemo-concentration.
HL	Like Lewisite and mustard.	Like sulfur mustard, nitrogen mustard and Lewisite.	Like H, HD and L.
CX	Powerful vesicant.	Apply dressings of sodium bicarbonate. Systemic analgesics. Treat as any other necrotic skin lesion.	No effects.
CG	Lung damaging agent.	Corticosteroids IV and by inhalation promptly may be life-saving. Rest, oxygen, antibiotics.	Shock after severe exposure, hypotension and tachycardia.
AC	Interferes with oxygen utilization at cellular level.	Drugs that bind cyanide: Methemoglobin formers; nitrites or DAMP. Dicobalt edetate and hydroxocobalamin. Thiosulphate. Assisted ventilation. Oxygen.	Profound hypotension. Rapid pulse.
CK	Like hydrogen cyanide, lung irritant.	Like hydrogen cyanide and phosgene.	No effects.
DM DA DC	Local irritant, induces vomiting.	Wear mask in spite of symptoms-the mask should be lifted in the event of vomiting. Spontaneous improvement.	No effects.
CN CA	Local irritant.	Spontaneous improvement. Analgesic eye and nose drops if necessary.	No effects.
CS CR	Local irritant.	Symptoms disappear rapidly in fresh air	No effects.
BZ	Anticholinergic.	Restraint, cool environment. Physostigmine Treatment may be required over several days.	Tachycardia, elevated blood pressure.
LSD	Psychomimetic.	Reassurance, restraint, prompt evacuation, diazepam.	Tachycardia.

Reference: Table C-I from FM 8-9 (Part III).

Table 5-O: Effects of Chemical Agents (continued)

Symbol	Eyes	Skin
GA GB GD GF VX	Miosis. Pain especially on focusing, dimness of vision, headache, lacrimation. Redness	Sweating, pallor then cyanosis.
H HD HN	Miosis. Pain Redness, irritation. Edema of lids, blepharospasm, photophobia lacrimation, corneal ulceration and possibly scarring.	No immediate signs. After minutes to hours, redness and burning. Several hours later blisters surrounded by redness and itching. Several days later necrosis, generally limited to epidermis. Delayed hyper- and hypo- pigmentation. Moist areas affected most. Risk of secondary infection.
L	Prompt redness, edema, irritation. Immediate burning, corneal injury	Prompt burning. Red within 30 minutes. Blisters on 1st or 2nd day. Pain worse and necrosis deeper than H.
HL	Like HD, HN and L.	Like L
CX	Violently irritating, redness, edema. Corneal injury with blindness, lacrimation.	Immediate severe irritation and intense pain. Within 1 minute the affected area turns white, surrounded by erythema. Blistered after 24 hours. Necrosis may occur. Long recovery (1-3 months).
CG	Irritation. Lacrimation (after respiratory symptoms).	Possible cyanosis following pulmonary edema.
AC	No effects.	Initially pinker than usual; may change to cyanosis.
CK	Irritation. Lacrimation.	Cyanosis.
DM DA DC	Irritation. Lacrimation.	Stinging, (especially of face), occasional dermatitis.
CN CA	Redness, irritation, pain, lacrimation, photophobia. Edema of eyelids.	Stinging, (especially of face) occasional dermatitis, may blister.
CS CR	Intense irritation. Pain, blepharospasm, lacrimation, photophobia.	Stinging, occasional dermatitis, may blister.
BZ	Mydriasis. Blurred vision.	Dry, flushed
LSD	Mydriasis	Sweaty palms, cold extremities.

Reference: Table C-I from FM 8-9 (Part III).

Table 5-P: Effects of Chemical Agents (continued)

Symbol	Nose and throat	Respiratory tract	GI tract
GA GB GD GF VX	Increased salivation. Rhinorrhea.	Tightness in the chest, bronchoconstriction, occasional wheezing, increased bronchial secretion, cough, dyspnea, substernal tightness.	Salivation, anorexia, nausea, vomiting, abdominal cramps, epigastric tightness, heartburn, eructation, diarrhea, tenesmus, involuntary defecation.
H HD HN	Swelling, irritation, ulceration, discharge, occasional edema of larynx.	Slowly developing irritation, hoarseness, aphonia, cough, tightness, dyspnea, rales. Pneumonia, fever, pulmonary edema, in severe cases. Risk of secondary infection.	Pain, nausea, vomiting, diarrhea.
L	Prompt irritation.	Rapid irritation, hoarseness, aphonia, cough, pneumonia, fever, pulmonary edema, pleural effusion in severe cases.	Diarrhea, nausea, vomiting, hepatic failure.
HL	Irritation	Inflammation, bronchitis, sneezing, coughing. Like HD.	Diarrhea.
CX	Very irritating to mucous membranes.	Rapid irritation and coughing. Later pulmonary edema.	No effects.
CG	Irritation	Coughing, choking, chest tightness on exposure. Latent period, then pulmonary edema, dyspnea, frothy sputum, pneumonia and fever.	Nausea, occasional vomiting after respiratory symptoms.
AC	No effects.	Deep respiration followed rapidly by dyspnea, gasping then cessation of respiration.	Nausea. Vomiting.
CK	Irritation	Irritation, cough, choking, dyspnea; pulmonary edema can be rapid. Tightness in chest; rales	Retching, vomiting, involuntary defecation
DM DA DC	Pain, rhinorrhea, tightness, sneezing.	Tightness and pain, uncontrollable coughing.	Salivation, nausea vomiting.
CN CA	Irritation, burning.	Tightness and irritation if concentration is high.	Occasional vomiting. Nausea.
CS CR	Irritation, burning, tightness, nosebleeds, rhinorrhea	Tightness in chest and difficulty breathing. Choking.	Nausea and retching, (rarely vomiting).
BZ	Extreme dryness.	No effects.	Constipation
LSD	No effects.	No effects.	No effects.

Reference: Table C-I from FM 8-9 (Part III).

Table 5-Q: Effects of Chemical Agents (continued)

Symbol	Genito-urinary	Central nervous system	Other
GA GB GD GF VX	Frequent micturition, urinary incontinence.	Apprehension, giddiness, insomnia, headache, drowsiness, difficulty concentrating, poor memory, confusion, slurred speech, ataxia, weakness, coma and areflexia, Cheyne-Stokes respiration, convulsions.	Fasciculations, easy fatigue, cramps, weakness (including respiratory muscles), paralysis.
H HD HN	No effects	Anxiety, depression.	Late depression of bone marrow, malaise and prostration.
L	Renal failure	Anxiety, depression.	Systemic arsenic poisoning.
HL	No effects	Anxiety, depression.	Systemic arsenic poisoning.
CX	No effects	Anxiety, depression.	No effects
CG	No effects	Anxiety, depression.	Chills, dizziness, thirst.
AC	No effects	May have initial excitation; then depression, giddiness, headache, irrational behavior, ataxia, convulsions or coma.	Weak, drowsiness.
CK	No effects	Convulsions.	Loss of appetite. Dizziness.
DM DA DC	No effects	Severe headache, mental depression.	May cause desire to remove protective mask.
CN CA	No effects	Headache.	No effects
CS CR	No effects	Headache.	Sense of suffocation may occur accompanied by fear.
BZ	Urgency-urinary retention.	Headache, giddiness, drowsiness, disorientation, hallucinations and occasional maniacal behavior. Ataxia and/or lack of coordination.	Fever.
LSD	No effects	Mental excitation, poor concentration, tremor indecisiveness, inability to act in a sustained or purposeful manner. Anxiety. Hallucinations.	Fever.

Reference: Table C-I from FM 8-9 (Part III).

Table 5-R: Physical Properties of Chemical Agents

Symbol	Appearance and Notes
GA	Clear, colorless, and tasteless liquid, chemically similar to organophosphate pesticides such as Malathion or Parathion. Has a slightly fruity odor. Solubility: miscible with water (H ₂ O)
GB	Clear, colorless, and tasteless liquid. Has a faintly sweet smell. Odorless in vapor and pure form. Solubility: miscible in water
GD	Clear, colorless, and tasteless liquid. Has slight camphor odor and gives off a colorless vapor.
GF	Liquid with sweet or musty odor of peaches.
VX	Oily liquid that is clear, odorless, and tasteless. It is amber colored similar in appearance to motor oil. Moderate solubility in water.
V _x	Liquid with faint fishy odor
H and HD	Liquid is colorless when pure, but it is normally a yellow to brown oily substance. Vapor is colorless with a slight garlic or mustard like odor. Sparingly soluble in H ₂ O; freely soluble in organic solvents.
HT	A mixture of 60% HD and 40% T. T is a sulfur, oxygen and chlorine compound similar to HD and is a clear yellowish liquid with a slight garlic or mustard like odor. Insoluble in water.
HN-1	Oily, colorless to pale yellow with a faint, fishy, or musty odor. Soluble in organic solvents.
HN-2	Pale amber to yellow oily liquid; fruity odor in high concentrations; smells like soft soap with a fishy smell in low concentrations. Soluble in organic solvents.
HN-3	Colorless to pale yellow liquid with a butter almond odor; most stable in storage of the three nitrogen mustards. Insoluble in water; soluble in organic solvents.
L	In a pure form Lewisite is a colorless and odorless liquid, but usually contains small amounts of impurities that give it a brownish color and an odor resembling geranium oil. It is heavier than mustard, poorly soluble in water but soluble in organic solvents.
HL	Dark oily liquid giving off a colorless vapor. Has garlic-like odor from its HD content. Insoluble in H ₂ O
CX	May appear as a colorless, low-melting point (crystalline) solid or as a liquid. It has a high vapor pressure, slowly decomposes at normal temperatures; it has a disagreeable, penetrating odor.
CG	Fog-like in its initial concentration, but it becomes colorless as it spreads; it has both a newly mown hay or green corn odor and a highly toxic suffocating odor. Extremely volatile and nonpersistent agent.
DP	Colorless liquid. It has a newly mown hay or green corn odor.
AC	Nonpersistent, colorless liquid that is highly volatile. It has a faint odor similar to bitter almonds that sometimes cannot be detected even at lethal concentrations.
CK	Colorless gas with a sharp, pepperish odor similar to that of most tear gasses. The odor of CK often goes unnoticed because it is so irritating to the mucous membranes. Slightly soluble in H ₂ O
DM	Light green to yellow crystals at room temperature; irritates nasal passages similar to pepper; no odor, but irritating. Insoluble in H ₂ O; Slightly soluble in common organic solvents.
DA	Colorless, crystalline, vapor odor is shoe polish, vapor color is white or gray
DC	Colorless, solid, vapor odor is garlic, vapor color is white
CN	Colorless to gray crystalline solid with a sharp, irritating floral odor. Odor threshold for CN is 0.1 mg/m ³ . Insoluble in water.
CA	In pure form, colorless crystalline solid with sour or rotten fruit odor. Insoluble in water. White smoke.
CNS	Clear liquid smelling like flypaper; it has an immediately strong irritating effect on the eyes and respiratory tract. May cause severe nausea.
PS	Colorless, oily liquid with a stinging pungent odor. Insoluble in water; soluble in organic solvents.
CS	White crystalline solid; burnt to create a colorless gas with an acrid pepper-like smell.
CR	Pale yellow crystalline solid; has a pepper-like odor.
BZ	An odorless white crystalline solid. Slightly soluble in H ₂ O; soluble in dilute acids.
LSD	Solid which is soluble in water.

Reference: Table C-I from FM 8-9 (Part III), FM 3-9, and USACHPPM's TG 218.

Table 5-S: Physical Properties of Chemical Agents (continued)

Symbol	Vapor toxicity LCt ₅₀ (mg-min/m ³)	Volatility (mg/m ³)					
		-10° C	0° C	20° C	25° C	30° C	40° C
GA	70		90		610	858	
GB	35		4 x10 ³	16 x10 ³	22 x10 ³	30 x10 ³	
GD	35		531		3.9 x10 ³	5.6 x10 ³	
GF	35			438	581		
VX	15				10.5		
V _x				48	75		
HD	1 x10 ³		75	610	610		2.8 x10 ³
HT	Unknown				831		
HN-1	1.5 x10 ³	127	308	1.5 x10 ³		3.1 x10 ³	
HN-2	3 x10 ³			1 x10 ³ (10°C)	3.6 x10 ³	5.1 x10 ³	10 x10 ³
HN-3	1.5 x10 ³		13		121	180	390
L	1.2 x10 ³		1 x10 ³	4.5 x10 ³		8.3 x10 ³	
HL	1.5 x10 ³	240		2.7 x10 ³		10 x10 ³	10 x10 ³
CX	3.2 x10 ³			20 x10 ³		60 x10 ³ (35°C)	74 x10 ³
CG	3.2 x10 ³	> 2x10 ⁶		> 5x10 ⁶ (10°C)			
DP			12 x10 ³	45 x10 ³			
AC	2 x10 ³	37 x10 ³ (- 40°C)			>1x10 ⁶		
CK	11 x10 ³			2.6x10 ⁶	>6x10 ⁶		
DM	11 x10 ³		19 x10 ³	~70 x10 ³	120 x10 ³		
DA				0.68			
DC				1.5			
CN	7-14 x10 ³		2.36	34.3			
CA	8-11 x10 ³		17	115		217	
CNS	11 x10 ³			605 x10 ³		900 x10 ³	
PS	2 x10 ³		56 x10 ³	164 x10 ³	210 x10 ³	267 x10 ³	
CS and CR	61 x10 ³				0.71		
BZ	200 x10 ³						

Reference: Tables 2-I and 7-II from FM 8-9 (Part III) and USACHPPM TG 218, and the Chemical Toxicity Integrated Product Team Joint NBC Defense Board Secretariat.

5.9. Nerve Agents

1. References: FM 8-9 (Part III), FM 8-10-7, and USAMRICD's *Field Management of Chemical Casualties*.
2. Introduction. Nerve agents are primarily organophosphorus esters similar to insecticides. Although some have been given names, they are usually known by their code letters: GA (TABUN), GB (SARIN), GD (SOMAN), and VX.
 - A. Nerve agents are all liquids, varying in volatility that is in a range between gasoline and heavy lubricating oil. The "G" agents tend to be non-persistent whereas the "V" agents are persistent. Some "G" agents may be thickened with various substances in order to increase their persistence, and therefore the total amount penetrating intact skin. At room temperature GB is a comparatively volatile liquid and therefore non-persistent. GD is also significantly volatile, as is GA though to a lesser extent. VX is a relatively non-volatile liquid and therefore persistent. It is regarded as presenting little vapor hazard to people exposed to it. V_x (pronounced "V sub x") is used by former Warsaw pact nations and its persistence is comparable to G agents.
 - B. In general, nerve agents are moderately soluble in water with slow hydrolysis, highly soluble in lipids, and rapidly inactivated by strong alkalis and chlorinating compounds.
3. Physical and Chemical Properties.
 4. Absorption. Nerve agents may be absorbed through any body surface. When dispersed as a spray or an aerosol, droplets can be absorbed through the skin, eyes, and respiratory tract. When dispersed as a vapor at expected field concentrations, the vapor is primarily absorbed through the respiratory tract. If enough agent is absorbed, local effects are followed by generalized systemic effects. The rapidity with which effects occur is directly related to the amount of agent absorbed in a given period of time and temperature.
 5. Protection. To prevent inhalation of an incapacitating or lethal dose, it is essential that the breath is held and the military mask put on at the first warning of nerve agent. Normal clothing is penetrated by these agents whether contact is with liquid or vapor and specialized clothing including a mask, nuclear, biological, and chemical protective overgarment, gloves and overboots are required for protection when liquid agent is present. Butyl rubber and synthetic material are more resistant than natural fibers. The mask protects the eyes, mouth and respiratory tract against nerve agent spray, vapor and aerosol. Nerve agent vapor in field concentrations is absorbed through the skin very slowly, so that where a vapor hazard exists alone, the mask may provide adequate protection without the use of an NBC overgarment. Agents can penetrate into nonabsorbent material such as web belts and can continue to present a hazard by desorption of the vapor. Though localized sweating and twitching may occur, usually there is no localized skin irritation after cutaneous exposure.
 6. Detection. Nerve agents can be detected by a variety of means. Single and three color detector papers (M9/M8) will detect liquid agent and are available for individual issue. Monitoring devices such as the Chemical Agent Alarm M8A1 and RSCAAL monitor for nerve agent vapor, and the CAM monitors for local vapor contamination. Water testing kits, such as the M272 are also available. For more information about detection see the chapter on chemical defense equipment.

7. General Effects of Nerve Agent.
 - A. Effects of Nerve Agent Vapor. The lungs and the eyes absorb nerve agents rapidly. In high vapor concentrations, the nerve agent is carried from the lungs throughout the circulatory system; widespread systemic effects may appear in less than 1 minute.
 - B. Effects of Liquid Nerve Agent. Following the ingestion of substances containing a nerve agent, which is essentially tasteless, the initial symptoms include abdominal cramps, vomiting, and diarrhea.
 - C. Cause of Death. In the absence of treatment, death is caused by anoxia resulting from airway obstruction, weakness of the muscles of respiration and central depression of respiration.
8. Pretreatment. Carbamate anticholinesterases, e.g., pyridostigmine, may be used as pretreatments against nerve agent poisoning. For further information see Chapter 2 of FM 8-9 (Part III).
9. Post-Exposure Therapy. The main principles of therapy for nerve agent poisoning are early treatment, assisted ventilation, bronchial suction, muscarinic cholinergic blockade (atropine), enzyme reactivation (2 Pam Chloride) and anticonvulsants (Diazepam). GD permanently binds to receptors in two minutes; after that 2 PAM Cl is not useful.
 - A. Self Aid (or Buddy Aid).
 - (1) This comprises first aid measures that the soldier can apply to help him or herself. The rapid action of nerve agents call for immediate self treatment. Unexplained nasal secretion, salivation, tightness of the chest, shortness of breath, constriction of pupils, muscular twitching, or nausea and abdominal cramps call for the immediate intramuscular injection of 2 mg of atropine, combined if possible with oxime. From 1 to 3 automatic injection devices (Mark I), each containing 2 mg atropine or mixture of atropine, oxime and/or anticonvulsant, are carried by each individual.
 - (2) One device should be administered immediately when the symptoms and/or signs of nerve agent poisoning appear. This may be done by the casualty or by a buddy; the injection being given perpendicularly through the clothing into the lateral aspect of the middle of the thigh. Further devices, up to a total of 3, should be administered by the casualty or by his or her buddy during the following 30 minutes if the symptoms and/or signs of poisoning fail to resolve.
 - (3) The timing of these further injections and whether they are given at one time or separately may depend on the casualty's condition and on instructions promulgated.
 - (4) NOTE: If automatic injectors are used in the absence of exposure to agent, the following signs and symptoms may be seen: Dry mouth, dry skin, fast pulse (>90 beats per minute), dilated pupils, retention of urine and central nervous system disturbance. Susceptibility to heat exhaustion or heat stroke is increased with ambient temperatures above 85°F, particularly in closed spaces or while wearing protective clothing, or while conducting any activity.

Table 5-T (Part 1): Time Course of Effects of Nerve Agents

Nerve agent	Types of effects	Route of Absorption	Description of effects
Vapor	Local	Lungs	Rhinorrhea, nasal hyperemia, tightness in chest, wheezing.
Vapor	Local	Eyes	Miosis, conjunctival hyperemia, eye pain, frontal headache.
Vapor	Systemic	Lungs or eyes	Muscarinic, nicotinic, and central nervous system effects.
Liquid	Local	Eyes	Same as vapor effects.
Liquid	Local	Ingestion	Gastrointestinal.
Liquid	Local	Skin	Local sweating and muscular twitching.
Liquid	Systemic	Lungs	Tightness in the chest, occasional wheezing, cough, dyspnea, substernal tightness
Liquid	Systemic	Eyes	Same as for vapor.
Liquid	Systemic	Skin	Generalized sweating.
Liquid	Systemic	Ingestion	Gastrointestinal.

Reference: Table 2-IV from FM 8-9 (Part III).

Table 5-T (Part 2): Time Course of Effects of Nerve Agents

When effects begin to appear after the exposure*	Duration of effects after:	
	Mild exposure	Severe exposure
One to several minutes.	A few hours.	1 to 2 days.
One to several minutes.	Miosis 24 hours.	2 to 3 days.
Less than one minute to a few minutes after moderate or severe exposure.	Several hours to a day.	Acute effects: 2 to 3 days. CNS effects: days to weeks.
Instantly.	Similar to effects of vapor.	
About 30 minutes after ingestion.	Several hours to a day.	2 to 5 days.
3 minutes to 2 hours.	3 days.	5 days.
Several minutes.		1 to 5 days.
Several minutes.		2 to 4 days.
15 minutes to 2 hours.		2 to 5 days.
15 minutes to 2 hours.		3 to 5 days.

*After lethal or near lethal exposure to nerve agents, the time to onset of symptoms and to maximal severity of symptoms is shorter; it may be extremely brief after overwhelming exposure. Following exposure to lethal concentrations, the time interval to death depends upon the degree, the route of exposure, and the agent. If untreated, exposure to lethal concentrations of nerve agents can result in death 5 minutes after appearance of symptoms.

Reference: Table 2-IV from FM 8-9 (Part III).

10. Pharmacological Treatment of Nerve Agent Poisoning.

A. Atropine. Atropine sulfate remains an essential drug in the treatment of nerve agent poisoning. It produces relief from many of the symptoms previously listed. In large doses, some therapeutic effects are also produced within the central nervous system. If atropine is administered in the absence of nerve agent poisoning, atropinization will occur. Higher doses, or repeated doses, will produce more marked symptoms that will usually not be totally incapacitating except in warm environments or high work rates. The effects of atropine are fairly prolonged, lasting 3 to 5 hours after one or two injections of 2 mg and 12 to 24 hours after marked over-atropinization.

B. Oximes (PAM Cl). Oximes relieve the clinically important symptom of skeletal neuromuscular blockade. However, they penetrate into the central nervous system poorly, and the simultaneous administration of atropine is therefore still required. The rapid injection of 2 PAM Cl can produce drowsiness, headache, disturbance of vision, nausea, dizziness, tachycardia and an increase in blood pressure, hyperventilation and muscular weakness. Additional information on the pharmacology of oximes is in *USAMRICD's Medical Management of Chemical Casualties* and FM 8-9 (Part III).

C. Anticonvulsants (Diazepam). Atropine protects only partially against convulsions and the resulting brain damage in severe poisoning. Complementary treatment, including anticonvulsants, should be applied as necessary. Diazepam is the drug of choice and should be injected intramuscularly as a 10-mg dose initially and further doses should be given frequently enough to control convulsions.

5.10. Blister Agents (Vesicants)

1. References: FM 8-9 Part (III) and USAMRICD's *Field Management of Chemical Casualties*.
2. Note: Latex and rubber (such as green overboots) absorb Mustard (HD).
3. General. There are three major families of blister agents (vesicants): sulfur mustard (HD) and nitrogen mustard (HN); the arsenical vesicants such as lewisite (L) (this may well be used in a mixture with HD); and the halogenated oximes (CX) whose properties and effects are very different from those of the other vesicants. Most vesicants (except CX) are relatively persistent. Vesicants burn and blister the skin or any other part of the body they contact. They act on the eyes, mucous membranes, lungs, skin and blood-forming organs. They damage the respiratory tract when inhaled and cause vomiting and diarrhea when ingested. Blister agents are likely to be used both to produce casualties and to force opposing troops to wear full protective equipment thus degrading fighting efficiency, rather than to kill, although exposure to such agents can be fatal. Blister agents can be thickened in order to contaminate terrain, ships, aircraft, vehicles, or equipment with a persistent hazard. Protection against these agents can only be achieved by a full protective ensemble. The respirator alone protects against eye and lung damage and gives some protection against systemic effects. Extensive, slow healing skin lesions will place a heavy burden on the medical services.
4. Physical and Chemical Properties.
 - A. The mustards are able to penetrate cell membranes in tissues and a great number of materials:

woods, leather, rubber, plants, etc. Due to their physical properties, mustards are very persistent in cold and temperate climates. It is possible to increase the persistency by dissolving them in non-volatile solvents, e.g., chlorinated rubber. In this way thickened mustards are obtained that are very difficult to remove by decontaminating processes. In warmer climates persistence of mustards is less but higher concentrations of vapor occur.

B. When dissolved in water, mustards are hydrolyzed at an appreciable rate, yielding poly-alcohols and hydrochloric acid (HCl), so that the solution may still be damaging to the skin. In 2 hours 22% of the initial concentration is hydrolyzed, in 6 hours 35% and in 24 hours 60%. However, as their solubility in water is very poor, two phases are generally formed and hydrolysis of the undissolved bulk is very slow. In running water the contact surfaces are frequently changed and persistency is only a few days, but in stagnant water, persistency can be several months. Mustard is denser than water, but small droplets remain on the water surface and present a special hazard in contaminated areas. Alkalinity and higher temperatures increase the rate of hydrolysis.

C. In water, Lewisite is hydrolyzed at an appreciable rate, forming an oxide that is equally vesicant. In contact with strong alkalis, lewisite is totally decomposed to non-vesicant products.

D. Phosgene oxime is a white crystalline powder; but by the addition of certain compounds it is possible to liquefy it at room temperature. It is fairly soluble in water and in organic solvents. In aqueous solution phosgene oxime hydrolyses fairly rapidly, especially in the presence of alkali. Its odor is very unpleasant and irritating. Phosgene Oxime is one of the few blister agents that cause pain upon contact with the skin. Even as a dry solid, phosgene oxime decomposes spontaneously and has to be stored at low temperatures.

5. Detection.

A. Mustards have the interesting property of forming, under certain conditions, colored complexes with para-nitrobenzpyridine thus making it possible to detect minute amounts. Mustard agents can be detected by a variety of means. Single and three color detector papers will detect liquid agent and are available for individual issue. Monitoring devices for local contamination and water testing kits are also available.

B. The detection of lewisite is facilitated by the fact that it forms colored products with many reagents. Draeger™ tubes are available which react with organic arsenicals. However, no automatic detectors are available for use in the field.

C. The characteristic signs and symptoms of phosgene oxime exposure may suggest its presence. There are no automatic detectors available for use in the field.

6. Protection. Ordinary clothing gives little or no protection against mustard agents, lewisite, or phosgene oxime. Special equipment including a mask, NBC protective overgarment, gloves and overboots are required. Due to slow absorption of mustard by many materials, protective equipment must be changed regularly according to Army doctrine.

7. Medical Effects of Mustard Agents.

A. General. Vesicants can penetrate the skin by contact with either liquid or vapor. The latent period is characteristic of the agent. For mustards it is usually several hours, for Lewisite it is short, and for oximes it is negligible. The latent period is also affected by the dose, temperature,

and humidity. Although blister agents can affect other organs and produce deleterious effects, the skin, eyes, and respiratory tract are the principal organs affected.

B. Prevention. No drug is available for the prevention of the effects of mustard on the skin and the mucous membranes. It is possible to protect the skin against very low doses of mustard by covering it with a paste containing a chlorinating agent, e.g., chloramine. The only practical prophylactic method is physical protection such as is given by the protective mask and special clothing.

C. Eyes. In a single exposure the eyes are more susceptible to mustard than either the respiratory tract or the skin.

D. Skin. Apart from mucous membranes the most sensitive areas are the face, armpits, genitalia, neck, skin between the fingers, and the nail beds. The palm of the hand, sole of the foot and the skin of the scalp are very resistant. The blisters are fragile and usually rupture spontaneously giving way to a suppurating and necrotic wound. The damaged tissues are extremely susceptible to infection. The regeneration of these tissues is very slow, taking from several weeks to several months, much longer than the time required for the restoration of skin destroyed by physical means or by caustic compounds.

Table 5-U: The Sequence of Skin Changes due to Mustard

Erythema (2-48 hour post exposure).	Reminiscent of scarlet fever. Slight edema of the skin. Intense itching. As the erythema fades areas of increased pigmentation are left. (This sequence is reminiscent of that seen in sun burn.)
Blistering (for higher doses, starts 4 - 24 hours after exposure) (blistering can go on for several days)	Blisters are not, per se, painful, though they may be uncomfortable and feel tense. Mustard blisters are delicate and may be easily ruptured by contact with bed linen, bandages or during transport of casualties. Crops of new blisters may appear as late as the second week post exposure. Blister fluid is not dangerous and does not produce secondary blistering if applied to skin.
Deep burning leading to full thickness skin loss.	Likely to occur on the penis and scrotum.

Reference: FM 8-9 (Part III).

E. Respiratory Tract. Mustard attacks all the mucous membranes of the respiratory tract.

F. Bone Marrow. Mustard agents may cause a general depletion of all elements of the bone marrow.

G. Gastrointestinal Tract. Ingestion of contaminated food or water may cause destruction of mucous membranes. Symptoms include nausea, vomiting, pain, diarrhea and prostration. These features may make casualties reluctant to eat. Vomit and feces may be bloodstained.

H. Systemic Action. Systemically absorbed mustards by any route, including severe skin exposure, may cause signs similar to those of irradiation, such as headache, nausea, vomiting, leukopenia, and anemia.

I. Post-Exposure Therapy. There is no specific treatment available for the treatment of mustard lesions. The aim of therapy is to relieve symptoms, prevent infections, and promote healing. Resolution of specific problems can be difficult to predict but the following may provide a guide.

(1) Eye lesions: Most are resolved within 14 days of exposure.

(2) Skin lesions: Deep skin lesions may be expected to heal in up to 60 days. Superficial lesions heal in 14-21 days.

(3) Upper respiratory tract lesions: It is very difficult to define a time course for complete recovery.

8. Medical Effects of Lewisite.

A. General. Due to its physical and chemical properties, lewisite can easily penetrate the skin, where it exerts its vesicant action. A distinctive stinging pain is felt in 10 to 20 seconds after contact with the skin. It can spread through the whole body and act as an arsenical poison.

B. Eyes. Liquid arsenical vesicants cause severe damage to the eye. Liquid arsenical vesicants instantly produce a gray scarring of the cornea, like an acid burn, at the point of contact.

C. Skin. Liquid arsenical vesicants produce more severe lesions of the skin than liquid mustard. The surrounding halo of erythema is less noticeable than with mustard blisters, although the two are often indistinguishable. The yellowish blister fluid is slightly more opaque than that of the mustard blister. It contains a trace of arsenic but is non-toxic and non-vesicant. Pain on contact with liquid arsenical vesicants usually gives sufficient warning so that decontamination may be begun promptly and deep burns thus avoided in conscious victims. Itching and irritation persist for only about 24 hours whether or not a blister develops. Blisters are often well developed in 12 hours and are painful at first, in contrast to the relatively painless mustard blister.

D. Respiratory Tract. The vapors of arsenical vesicants are so irritating to the respiratory tract that conscious casualties will immediately put on a mask to avoid the vapor. The respiratory lesions are similar to those produced by mustard except that in the most severe cases, pulmonary edema may be accompanied by pleural effusion.

E. Systemic Effects. Liquid arsenical vesicants on the skin, as well as inhaled vapor, are absorbed and may cause systemic poisoning. A manifestation of this is a change in capillary permeability, which permits loss of sufficient fluid from the bloodstream to cause hemoconcentration, shock, and death.

F. Treatment of Lewisite Lesions. The treatment of lewisite lesions is detailed in Chapter 3 of FM 8-9 (Part III). An antidote for lewisite is dimercaprol, BAL (British Anti Lewisite). However, the toxicity of dimercaprol itself must be considered. It sometimes provokes local irritation.

9. Medical Effects of Phosgene Oxime. In low concentrations, phosgene oxime severely irritates the eyes and respiratory organs. In high concentrations, it also attacks the skin. Very few compounds are as painful and destructive to the tissues. The action on the skin is immediate: phosgene oxime provokes irritation resembling that caused by a stinging nettle.

5.11. Blood Agents (Cyanogen Agents)

1. References: FM 8-9 (Part III), FM 8-285, and USAMRICD's *Field Management of Chemical Casualties*.
2. General. Blood agents consist of hydrogen cyanide (AC) and cyanogen chloride (CK). The mucous membranes and the intact skin readily absorb both AC and CK. Initial symptoms are characterized by violent convulsions, increased deep respiratory movements, followed by cessation of respiration within one minute, slowing of heart rate to death. High concentrations exert their effects rapidly; however, if the patient is still alive after the cloud has passed, he or she will probably recover spontaneously. Cyanogen chloride and cyanogen bromide after absorption reacts in such a way that hydrogen cyanide is eventually released. Their effects on the body are essentially similar to those of hydrogen cyanide, but, in addition, they also have local irritant effects.
3. Chemical Properties.
 - A. The cyanogen compounds hydrolyze slowly in water with subsequent gradual loss of toxicity. They are readily oxidized by strong oxidants; e.g., potassium permanganate. Hydrogen cyanide has an affinity for oxygen and is flammable; hence it is less efficient when dispersed by artillery shells.
 - B. Cyanogen chloride is only slightly soluble in water, it dissolves readily in organic solvents. Cyanogen chloride's pungent, biting odor is marked by its irritating lacrimatory properties. Normally cyanogen chloride is non persistent.
 - C. Cyanogen halides are rather poorly absorbed onto charcoal, especially if the charcoal is damp.
4. Detection. Automatic detectors are available which detect attack concentrations of vapors of hydrogen cyanide, cyanogen chloride and cyanogen bromide. Draeger™ tubes are also available, as are water testing kits.
5. Protection. The charcoal in the canister of the protective mask poorly absorbs Hydrogen cyanide. This charcoal is therefore impregnated with metal salts in order to improve the performance of the canister, but the protection provided against HCN is not unlimited. Cyanogen Chloride (CK) is also poorly absorbed by the metallic salt-impregnated charcoal filters in the protective mask. Nevertheless, standard military protective masks provide adequate protection against field concentrations of blood agent vapors.
6. Medical Effects of Hydrogen cyanide (AC).
 - A. The cyanide ion forms a reversible complex with the respiratory cytochrome oxidase enzyme system, an enzyme system essential for oxidative processes within cells. This results in impairment of cellular oxygen utilization. The central nervous system, particularly the respiratory center, is especially susceptible to this effect and respiratory failure is the usual cause of death.
 - B. Treatment. Successful treatment for acute cyanide poisoning depends upon rapid fixation of the cyanide ion, either by methemoglobin (metHB) formation or by fixation with cobalt compounds. Drug treatments include, compounds producing Methemoglobin, Hydroxycobalamin, and Dicobalt edetate. Any casualty who is fully conscious and breathing

normally more than 5 minutes after presumed exposure to cyanide agents has ceased will recover spontaneously and does not require treatment, cyanide being very rapidly detoxified in the body. Artificial resuscitation, though possible, is not likely to be helpful in the absence of drug treatment. First Aid Measures: the casualty should be removed from the source of hydrogen cyanide. Rescue workers should wear adequate individual protective equipment (IPE).

C. The medical effects and treatment of hydrogen cyanide are detailed in Chapter 6 of FM 8-285 and Chapter 5 of FM 8-9 (Part III).

7. Medical Effects of Cyanogen Chloride (CK).

A. Cyanogen chloride acts in two ways: Its systemic effects are similar to those of hydrogen cyanide but it also has local irritant effects on the eyes, upper respiratory tract, and lungs. Cyanogen chloride injures the respiratory tract, resulting in severe inflammatory changes in the bronchioles and congestion and edema in the lungs. Very low concentrations (e.g., 10-20 mg.min.m³) produce eye irritation and lacrimation.

B. Signs and Symptoms. The signs and symptoms caused by cyanogen chloride are a combination of those produced by hydrogen cyanide and a lung irritant. Initially, cyanogen chloride stimulates the respiratory center and then rapidly paralyzes it. In high concentrations, however, its local irritant action may be so great that dyspnea is produced.

C. Treatment. Cyanogen chloride poisoning should be treated in the same way as hydrogen cyanide poisoning as regards to its cyanide-like effects. Pulmonary irritation should be treated in the same way as phosgene poisoning.

D. Course and Prognosis. Recovery from the systemic effects of cyanogen halide poisoning is usually as prompt as in hydrogen cyanide poisoning. However, a higher incidence of residual damage to the central nervous system is to be expected. Depending on the concentration of cyanogen halide to which the casualty has been exposed, the pulmonary effects may develop immediately or may be delayed until the systemic effects have subsided. Early prognosis must, therefore, be guarded.

5.12. Choking Agents (Lung-Damaging Agents)

1. References: FM 8-9 (Part III), FM 8-285, and USAMRICD's *Field Management of Chemical Casualties*.
2. General. Chemical agents that attack lung tissue, primarily causing pulmonary edema, are classified as lung damaging agents. Phosgene (CG), diphosgene (DP), chlorine (Cl), and chloropicrin (PS) belong to this group. Certain other substances, while, not likely to be used as agents, are still likely to be met with on the battlefield (e.g., nitrous fumes and zinc chloride, the major component of HC smoke in a solid state) and may have a similar action. Similar substances encountered in fires, e.g., perfluoroisobutylene (PFIB) and HCl may also induce lung damage.
3. Chemical Properties. Phosgene is readily soluble in organic solvents and fatty oils. In water, phosgene is rapidly hydrolyzed with the formation of hydrochloric acid and carbon dioxide.
4. Detection. There are no automatic detectors available for use in the field.
5. Protection. The protective mask gives adequate protection against this agent.

6. Medical Effects of Phosgene.

A. The mode of action is still not fully understood. Whatever the mechanism of action, phosgene increases the permeability of the alveolar capillaries with resultant pulmonary edema. This interferes with pulmonary gaseous exchange, leading to hypoxia.

B. Although effects are primarily confined to the lungs, phosgene may also cause mild irritation of the eyes and upper respiratory tract. Initially, hypoxemia occurs and is followed shortly by hyperventilation when the frothy edema fluid fills the bronchioli and CO₂ expiration stops.

C. Initial treatment is rest and warmth. It is desirable that a casualty exposed to a lung-damaging agent be kept at rest until the danger of pulmonary edema is past, but the operational situation may prevent this. The casualty should be evacuated in a semi-seated position if dyspnea or orthopnea make a supine posture impractical. Mandatory evacuation by litter in cases of significant respiratory involvement has been advocated. Sedation should be used sparingly. Codeine may be effective for cough. Hypoxemia may be controlled by oxygen supplementation.

D. During the acute phase, casualties may have minimal signs and symptoms and the prognosis should be guarded. Casualties may very rapidly develop severe pulmonary edema. If casualties survive more than 48 hours they usually recover without sequelae.

E. The medical effects and treatment of lung-damaging agents are detailed in Chapter 4 of FM 8-9 (Part III), and Chapter 5 of FM 8-285.

5.13. Incapacitating Agents

1. References: FM 8-9 (Part III) and USAMRICD's *Field Management of Chemical Casualties*.

2. General.

A. Incapacitating agents are chemicals which produce a temporary disabling condition that persists for hours to days after exposure to the agent has ceased (unlike that produced by riot control agents). While not required, medical treatment produces a more rapid recovery. Characteristics of these agents are:

- (1) They are highly potent and logistically feasible.
- (2) They produce their effects mainly by altering or disrupting the higher regulatory activity of the central nervous system (CNS).
- (3) The duration of their effects is hours or days rather than momentary or fleeting.
- (4) They do not seriously endanger life, except in high doses.
- (5) They produce no permanent injury.

B. CNS depressants produce their effects by interfering with transmission of information across central synapses. In the central nervous system anticholinergic compounds disrupt the high integrative functions of memory, problem solving, attention and comprehension. Relatively high doses produce toxic delirium that destroys the ability to perform any military task.

C. Central nervous system stimulants are agents that cause excessive nervous activity, often by boosting or facilitating transmission of impulses across synapses. The effect is to "flood" the cortex and other higher regulatory centers with too much information, making concentration difficult and causing indecisiveness and an inability to act. These include d-lysergic acid

diethylamide (LSD), psilocybin, and mescaline.

3. **Chemical Properties.** BZ and its analogues are glycolic acid esters. Although BZ is only slightly soluble in water, incapacitating doses can readily be absorbed from drinking water. It is a very difficult agent to disseminate and consequently is likely to be used by an enemy only in a clandestine manner.
4. **Detection.**
 - A. Field laboratory methods are not yet sufficiently developed to permit isolation and identification of specific agents in the environment and in samples of body fluid (for example, blood, urine, cerebrospinal fluid). Therefore, diagnosis rests almost entirely upon chemical acumen, combined with whatever field intelligence or detector system data may be available. Following the occurrence of a suspected chemical attack with incapacitating agents, the medical officer should be prepared to take the steps listed below.
 - B. Instruct field evacuation teams to transport casualties to an uncontaminated area. Resistant or disoriented individuals should be restrained in the triage area after they have been given the necessary first aid.
 - C. In a large-scale attack, the diagnosis will be simplified by the epidemiological distribution of the casualties. It is better to look for characteristics common to all or most casualties, than to be overly impressed with atypical features.
 - D. There is no device available at present for detecting BZ.
 - E. There is no device available at present for detecting LSD.
5. **Protection.** It is likely that such agents will be dispersed by smoke-producing munitions or aerosols, using the respiratory tract as a portal of entry. For BZ, protection is given by the protective mask, NBC protective overgarment, overboots, and gloves. No personal protection is available against clandestine attack of LSD, but it seems probable that only small quantities of food or water could be contaminated. Good security of the food and water supply are therefore required to protect against LSD contamination.
6. **Medical Effects of CNS Depressants - BZ (3-quinoclidinyl benzilate) and similar compounds.**
 - A. **Mechanism of Action.** BZ (3-quinoclidinyl benzilate) is a cholinergic blocking agent that at single doses of less than 1 mg produces delirium lasting several days. No permanent adverse effects have been reported from clinical studies. BZ is effective by all routes of administration, but its effectiveness percutaneously (when mixed with a suitable solvent) is limited, so that route is not likely to be used.
 - B. **Signs and Symptoms.** Small doses of BZ cause sleepiness and diminished alertness. Increased heart rate, dry skin and lips, drowsiness and a progressive intoxication in the untreated individuals can be used for diagnosis.
 - C. **Treatment.** Reversal of the effects of BZ by the drug physostigmine, has been clearly demonstrated to be both safe and effective when properly used in healthy individuals (information paper MCMR-UV-ZB dated 9 Feb 1998). For most casualties, symptomatic treatment is all that will be necessary. Firm restraint when necessary and a friendly attitude are called for especially in dealing with these subjects who are capable of walking. All dangerous objects must be removed

and anything likely to be swallowed should be kept away from the subject as bizarre delusions may occur. The most important single medical consideration is the possibility of heat stroke. Clothing should be removed if the temperature is greater than 25°C. If the body temperature is greater than 39°C vigorous cooling is indicated. Water may be sprayed on the casualty to aid cooling, ice should not be applied to the skin.

D. The medical effects and treatment of BZ are detailed in Chapter 6 of FM 8-9 (Part III) and Chapter 3 of FM 8-285.

Table 5-V: Signs and Symptoms Produced by Incapacitating Agents

Signs and symptoms	Possible etiology
Restlessness, dizziness, or giddiness; failure to obey orders, confusion, erratic behavior; stumbling or staggering; vomiting.	Anticholinergics (e.g., BZ), indoles (e.g., LSD), cannabinoids (e.g., marijuana), anxiety reaction
Dryness of mouth, tachycardia at rest, elevated temperature, flushing of face; blurred vision, pupillary dilation; slurred or nonsensical speech, hallucinatory behavior, disrobing, mumbling and picking behavior, stupor and coma.	Anticholinergics.
Inappropriate smiling or laughter, irrational fear, distractibility, difficulty expressing self, perceptual distortions; labile increase in pupil size, heart rate, blood pressure. Stomach cramps and vomiting may occur.	Indoles. (Schizophrenic psychosis may mimic in some respects.)
Euphoria, relaxed, unconcerned, daydreaming, easy laughter, hypotension and dizziness after suddenly standing	Cannabinols.
Tremor, clinging or pleading, crying; clear answers, decrease in disturbance with reassurance; history of nervousness or immaturity, phobias.	Anxiety reaction.

Reference: Table 6-1 from FM 8-9 (Part III).

7. Medical Effects of CNS Stimulants - LSD.

A. Mechanism of Action. Very small doses (for example 50 micrograms per person) are capable of inducing a psychotic state in people, but the precise mechanism of action is not yet known. It appears to interfere with the normal filtering action of this system, permitting sensory input to reach higher integrative centers without regard to its importance or relevance. The result is a decrease in the ability of the brain to process information selectively and in logical sequence.

B. Pathophysiology. LSD may be inhaled or ingested. Maximum effects are reached within 2 to 3 hours and gradually subside over the next 4 to 8 hours. Tolerance is acquired rapidly on repeated exposures at daily intervals, but is short lived.

C. Signs and Symptoms. The clinical manifestations of LSD intoxication often include an early stage of nausea followed 45-60 minutes after dosage by a confused state in which delusions and hallucinations are common but not always experienced. Subjects intoxicated with LSD show evidence of sympathetic stimulation and mental excitation.

D. Treatment. The best treatment known at present for LSD intoxication is the administration of diazepam 10-20 mg intravenously or intramuscularly or sodium amytal 200-400 mg intravenously to sedate the patient until spontaneous recovery occurs.

E. The medical effects and treatment of LSD are detailed in Chapter 6 of FM 8-9 (Part III).

5.14. Riot Control Agents

1. References: FM 8-9 (Part III), Chapter 7 of FM 8-285, and USAMRICD's *Field Management of Chemical Casualties*.

2. General. Riot control agents are irritants characterized by a very low toxicity and a short duration of action. Little or no latent period occurs after exposure. Orthochlorobenzylidene malononitrile (CS) is the most commonly used irritant for riot control purposes. Chloracetophenone (CN) is also used in some countries for this purpose in spite of its higher toxicity. A newer agent is dibenzoxazepine (CR) with which there is little experience. Arsenical smokes (sternutators) have in the past been used on the battlefield. Apart from their lacrimatory action they also provoke other effects, e.g., bronchoconstriction and emesis and are some times referred to as vomiting agents. For historical reasons some older, more toxic compounds are briefly mentioned.

3. Chemical Properties.

A. CS has superseded CN on account of its stronger irritant effects and its lower toxicity. Solubility is very poor in water, moderate in alcohol, and good in acetone, chloroform, and benzene. CS is unstable in aqueous solution. If enough CS can be dissolved in water (e.g., by adding propylene glycol or other organic co-solvent) spraying fluids with an irritant action of short duration result. Although the smoke is non-persistent, CS may stick to rough surfaces (e.g., clothes) from which it is released only slowly. At least 1 hour of aeration is necessary to cleanse such materials from CS after exposure. CS is usually dispersed as an aerosol generated pyrotechnically, or by spraying a solution of CS in a suitable solvent.

B. CR is stable in organic solutions. It has limited solubility in water and is not hydrolyzed in aqueous solutions. The agent is currently used only in solution for dissemination in liquid dispensers. The solution in the dispensers contains 0.1% CR in 80 parts propylene glycol and 20 parts water. CR differs from CS in being less toxic when inhaled but CR skin effects are more pronounced. It is more persistent in the environment and on clothing. CR is similar in its effects to CS, but the minimum effective concentration is lower and the LCt50 is higher. Symptoms and treatment are similar to those of CS.

C. CN dissolves in organic solvents. CN is more toxic than CS. CN is a riot control agent and as a training agent is now superseded by CS, the latter being much less toxic. However, it is still in use by police in some countries.

D. Bromobenzyl cyanide (CA) and bromoacetone (BA) are older lacrimators. They are too toxic for use as riot control agents and must be considered obsolete.

4. Detection. The CS cloud is white at the point of release and for several seconds after release.

5. Protection. Full individual protective equipment will provide complete protection. Protection against field concentrations of irritant agents is provided by the protective mask and ordinary field clothing secured at the neck, wrists, and ankles.

6. Medical Effects of CS. A burning sensation occurs especially in moist areas, but soon disappears. This burning sensation may recur some hours later, often while washing the area. In practically all cases it is sufficient to take the patient into fresh air where the symptoms will soon disappear. Clothing should be changed. If symptoms persist the eyes, mouth and skin may be washed with water (and with soap in the case of the skin). Oil based lotions should not be used. Skin decontaminants containing bleach should not be used, but should be reserved for more dangerous contamination (e.g., vesicants or nerve agents); bleach reacts with CS to form a combination which is more irritant to the skin than CS alone. CS hydrolyses more rapidly in alkaline solutions and an acceptable skin decontamination solution is 6.7% sodium bicarbonate, 3.3% sodium carbonate and 0.1% benzalkonium chloride. The medical effects and treatment of CS are detailed in Chapter 7 of FM 8-9 (Part III).
7. Medical Effects of CN. The mode of action is similar to that of CS; CN causes stimulation of sensory nerve endings. The severest of these symptoms is reached in a few minutes and then gradually decreases. After about 1 or 2 hours, all symptoms disappear. Drops or splashes in the eye may cause corrosive burns, corneal opacity, and even permanent visual impairment. After limited operational exposure, letting fresh air blow into the open eyes will adequately neutralize ill effects. If necessary the eyes may be washed with water from the water bottle (canteen). The eyes should never be rubbed as mechanical injury may complicate the chemical effect. Patients suffering from temporary blindness should be reassured; permanent blindness from exposure to vapor has never been observed even at very high concentrations.

5.15. Vomiting Agents

1. Reference: FM 8-9 (Part III).
2. General. Vomiting agents produce strong pepper-like irritation in the upper respiratory tract with irritation of the eyes and lacrimation. They cause violent uncontrollable sneezing, cough, nausea, vomiting, and a general feeling of bodily discomfort. The principal agents in this group are diphenylchlorarsine (DA), diphenylaminearsine chloride Adamsite (DM), and diphenylcyanarsine (DC). DA, DM, and DC are also classed as sternutators. They are dispersed as aerosols and produce their effects by inhalation or by direct action on the eyes. Vomiting agents can be used in conjunction with lethal agents to force troops to unmask.
3. Physical and Chemical Properties. They are non-persistent agents. The particles fall to the ground after dispersion and are virtually ineffective unless resuspended. Diphenyl-cyanoarsine (DC) is the most irritating of the group. The color of the solid agent depends on the degree of purity (technically raw products are often colored). The color and odor of the smoke after dispersion may no longer be noticeable in concentrations which are nevertheless still highly irritant, so that odor and color cannot be relied upon for detection.
4. Detection. The use of these agents may be suspected by the clinical symptoms and signs.
5. Protection. Full individual protective equipment will provide complete protection. The standard protective mask and ordinary field clothing gives adequate protection against field concentrations of vomiting agents. Put on the protective mask and wear it in spite of coughing, sneezing, salivation and nausea. Lift the mask from the face briefly if necessary to permit vomiting or to drain saliva from the facepiece. Carry on with duties as vigorously as possible - this will help to

lessen and shorten the symptoms. Combat duties usually can be performed despite the effects of vomiting agents.

6. **Medical Effects of Vomiting Agents.** The onset of symptoms may be delayed for several minutes after initial exposure (especially with DM); effective exposure may, therefore, occur before the presence of the smoke is suspected. If the mask is put on then, symptoms will increase for several minutes despite adequate protection. As a consequence, the casualties may believe their mask is ineffective and by removing it expose themselves further. Prolonged exposure may cause retrosternal pain, dyspnea and asthma-like symptoms. Symptoms reach their climax after 5 to 10 minutes and disappear 1 to 2 hours after cessation of exposure. In spite of the dramatic appearance of the syndrome, the only treatment necessary is first aid. The patient should not smoke for some hours. If necessary the mouth may be rinsed with water, but the water should not be swallowed. The medical effects and treatment of vomiting agents are detailed in Chapter 7 of FM 8-9 (Part III).

5.16. Toxic Industrial Compounds (TICs)

1. **References:**
 - A. International Task Force, Final Report 25: Hazard from Industrial Chemicals, Reconnaissance of Industrial Hazards: Chemical, Biological, Radiological- Tactic, Techniques, and Procedures.
 - B. USACHPPM's TG 230 (See this guide for specific chemical information)
 - C. Ace Directive 80-64.
 - D. The Agency for Toxic Substances and Disease Registry (ATSDR) three volume series on Managing Hazardous Materials Incidents. Contains over 200 toxicological profiles. The internet address is <http://atsdr1.atsdr.cdc.gov:8080/atsdrhome.html>.
2. **General.** US forces have been deployed throughout the world in a variety of military missions. If deployed in a traditional role of waging war in a highly industrialized area, the deliberate or accidental release of industrial chemicals is practically assured. With limited conflicts and highly sophisticated weapons, such as smart bombs, major industrial sites can be targeted selectively to ensure that collateral damage is minimized. However, with the post-Cold War world, the traditional role of the military is being superseded by involvement in Operations Other Than War (OOTW). Toxic Industrial Chemicals (TICs) have been defined by the ITF-25 report as an industrial chemical that has a LC_{t50} value less than 100,000 mg-min/m³ (approximately the same as that of ammonia) in any mammalian species and is produced in quantities exceeding 30 tons per year at one production facility.
3. **Chemical Hazards.** Chemicals can have many different compositions, structures, and properties. Chemical reactions can be extremely energetic, producing fires or explosions. The following is a list of chemical classes and their associated hazards:
 - A. *Toxic Compounds* are poisons that cause acute or chronic health problems. The toxicity of a compound depends on the nature of the compound, the concentration, and the method of exposure.
 - B. *Corrosive Compounds* cause destruction or damage to living tissue by chemical action at the site of contact.

- C. *Irritating Compounds* are not corrosive but cause reversible inflammation on living tissue by chemical action.
- D. *Flammable or Combustible Compounds* are any solids, liquids, or gases that ignite easily or burn rapidly. They are classified as compounds with a flash point below 100° F.
- E. *Explosives* are chemicals or mixtures that cause sudden, almost instantaneous release of pressure, gas, and heat when subjected to sudden shock, pressure, or high temperature.
- F. *Organic Peroxides* are a type of oxidizer that is very reactive and potentially explosive, as well as corrosion or flammability hazards.
- G. *Oxidizers* are substances that yield oxygen readily to stimulate the combustion (oxidation) of organic matter.
- H. *Pyrophoric Compounds* are materials that ignite spontaneously in air at a temperature below 130°F. They require special storage in containers that are sealed in inert gas.
- I. *Unstable Compounds* tend toward decomposition or other unwanted chemical change during normal handling and storage. These compounds may polymerize, decompose, condense, or be self-reactive, either spontaneously or under conditions of shock, pressure, or temperature, possibly with a large release of energy.
- J. *Water Reactive Compounds* react with water to produce a large amount of energy.
4. List of High Hazard TICs. ITF-25 was tasked to rank chemicals according to their hazard index. ITF-25 considered that for a given chemical to present a hazard in a military situation, the chemical must be present in sufficient quantity in the area of concern, must exhibit sufficient toxicity by inhalation and must normally exist in a state which could give rise to an inhalation hazard. The following is a list of toxic industrial chemicals that received a high hazard index ranking. See USACHPPM TG 230 for the toxicity values associated with these and other toxic industrial compounds that may be encountered in the field.

Table 5-W: List of High Hazard TICs

Ammonia	Arsine	Boron trichloride
Boron trifluoride	Carbon disulfide	Chlorine
Diborane	Ethylene oxide	Fluorine
Formaldehyde	Hydrogen bromide	Hydrogen chloride
Hydrogen cyanide	Hydrogen fluoride	Hydrogen sulfide
Nitric acid, fuming	Phosgene	Phosphorus trichloride
Sulfur dioxide	Sulfuric acid	Tungstenhexafluoride

Reference: International Task Force, Final Report 25.

5.17. ACE Directive 80-64: NATO's Policy on Toxic Industrial Chemicals

General Information: ACE DIRECTIVE 80-64: ACE Policy for Defensive Measures against Toxic Industrial Chemical during Military Operations is NATO guidance. It is not presently guidance for all US forces, however the latest draft of Joint Pub 3-11 does contain similar guidance. The directive is presented below in its original form with slight editing to reduce its length.

REFERENCES for ACE Directive 80-64: ACE Directive 75-3, ACE Directive 80-14, STANAG 2002, STANAG 2103, STANAG 2112, STANAG 2150, and STANAG 2352.

1. **APPLICABILITY.** This directive is applicable to all permanent and temporary International Military Headquarters and formations under operational control of SACEUR. Non-NATO forces participating in NATO led multinational operations will be invited to adapt the measures set out in this directive.
2. **PURPOSE.** To designate defensive measures against Toxic Industrial Chemical Hazards that may be encountered during military operations.
3. **BACKGROUND.**
 - A. During military operations, hazards normally considered insignificant during wartime may become important and impact operations. These hazards may be more significant during operations other than war such as peace support operations. One of the hazards that may confront ACE forces are massive quantities of Toxic Industrial Chemicals (TIC) in storage, production, distribution or transportation. TICs, if deliberately or inadvertently released, will pose hazards to the indigenous population and NATO forces operating in the area. The risk from TICs is not only linked to the risk from a single chemical compound but from risks that result from explosion, fires, and the associated byproducts.
 - B. This directive will outline policy and procedures for ACE force protection to mitigate hazard from the release of Toxic Industrial Chemicals. Wherever applicable the policy will reference current NATO Standardization Agreements, Allied Tactical Publications and ACE Directives will follow standard NATO concepts and doctrine.
4. **POLICY.** The following general policies apply with regard to exposure of ACE forces to known Toxic Industrial Chemical hazards:
 - A. Deliberate exposure of ACE forces to a TIC hazard shall not be permitted unless it is required by military necessity. Formations that do not possess the appropriate equipment, personnel, and training as described in this document and other relevant NATO standards shall not be employed in TIC hazard areas.
 - B. Detailed planning and coordination for the conduct of operations in the area of a TIC hazard is essential.
 - C. All levels of command should keep a totally open flow of information regarding the existence and status of TIC hazard areas. However, Commanders should be aware that potential belligerents could use the threat of the release as well as the actual release of TICs to increase

tensions. Therefore, Commanders shall apply an appropriate level of security with regards to this information.

D. Commanders shall ensure subordinate formations are aware of this policy and have the appropriate equipment and personnel to implement it.

E. Commanders shall consult with all appropriate staff specialists prior to any operations in TIC hazard areas. At a minimum, this consultation shall include the NBC Defense Officer, Legal Officer, Medical Officer, Intelligence Officer, and Public Affairs Officer. Additionally, the Commander should request additional operational and scientific expertise from national sources in the event of an actual accident.

5. PROCEDURES. The following specified procedures apply to ACE forces performing operations in an area where there is a risk of exposure to Toxic Industrial Chemicals.

A. General.

(1) Most toxic industrial chemicals potentially representing hazards to NATO forces will present a vapor (inhalation) hazard. The vapor concentration at the point of release may be very high and may reduce the oxygen concentration below that required to support life. The toxic vapors may be denser than air, hugging the ground and flowing along low-lying areas such as valleys and ravines. Vapors tend to flow into cellars, and high concentrations will linger in buildings, woods or other places where there is little air circulation. Subject to overriding operational requirements, the preferred positions for locating static military facilities, in an area of operations where TIC are a consideration, are at higher elevations, on open ground and upwind or away from the sources of TICs.

(2) The most important action in the case of a massive release of an industrial chemical is immediate evacuation. It is vitally important that commanders and troops are aware that the best defense against the release of TICs is to escape the path of the TIC immediately. Current military respirator canisters can provide only very limited protection and shall only be used to escape the hazard area. Additionally, TICs can displace oxygen thus rendering respirators totally ineffective.

B. Intelligence.

(1) Prior to entry into the area, intelligence assets shall provide the NATO operational and local commanders with suspected areas that contain TICs. The intelligence community shall endeavor to obtain all pertinent information involving production and storage facilities of TICs. At a minimum the type of TICs and quantities at each location shall be provided to the Commander. Additionally, there is a need for Commanders to be informed on the specific risk (fire, explosion, toxicity, corrosive effects, and persistency of gas) as well as the efficiency of collective and individual protection systems. Intelligence assets should query the appropriate scientific, civilian industrial and chemical warfare treaty experts in order to gather all applicable information. When possible, local industrial site survey forms shall be obtained for all identified sites.

(2) Commanders in the local area shall make every attempt to obtain information about toxic industrial chemical facilities within their area of operation. Sources of information include the safety report and safety data sheets on the facility, international code marking on storage

tanks, and local civilian authorities that may also have additional emergency response procedures/resources.

(3) Once all information on a TIC production or storage site has been compiled, the intelligence community shall endeavor to provide a comprehensive risk assessment to the commander in the field.

C. Exclusion Areas for Toxic Industrial Chemical Facilities and Hazards

(1) Intact Facilities.

(a) The operational commander shall dictate a safety exclusion area around TIC facilities commensurate with current intelligence and technical assessment. If the location of the source is defined and no release has occurred the commander shall establish a minimum safety exclusion zone of a 1-KM radius around the TIC facility. NATO forces shall only enter this exclusion area when military necessity dictates. Furthermore, the commander shall attempt to avoid encampment of mobile units within a 5-KM radius and fixed semi-permanent and permanent encampments within 10 KM of the facility. NATO forces within these safety radii shall have military respiratory protection on their person, Aviation assets are permitted to transit the exclusion zone at a minimum height of 150 meters.

(b) The commander may deviate from these safety exclusion areas based upon a detailed survey and assessment of the intact TIC facility by the appropriate scientific and military experts.

(2) Toxic Industrial Chemical Release.

(a) If a Toxic Industrial Chemical release does occur from the facility, the Commander shall first ensure all NATO forces are evacuated from the area and establish a 5 KM safety exclusion zone until a chemical hazard prediction is produced. A chemical hazard prediction will be produced in accordance with Allied Tactical Publication 45. The prediction used will be Type A (Case 1 or 2 depends on weather conditions). Once the prediction is produced and disseminated, NATO forces shall not enter this zone until follow-on actions are taken and as required by military necessity. Additionally, the commander shall attempt to avoid encampment of all units within a 10-KM radius of the center of the hazard release.

(b) The Commander may deviate from these exclusion areas once a detailed survey and assessment of the extent and probable hazard area is completed by appropriate scientific and military experts.

(c) If the position of the TIC release is known, the event shall be reported using the NBC-1 format identifying the message as an NBC-1 ROTA (ROTA stands for Release Other Than Attack). The Lines BRAVO, CHARLIE, DELTA, ECHO, FOXTROT, GOLF, HOTEL, INDIA, KILO, YANKEE, ZULU ALPHA AND GENTEXT within the report will contain the information currently described for traditional NBC reports. Line GOLF will include the ROTA source. Line HOTEL will indicate TIC or the specific chemical compound if known. Line INDIA will indicate a description of the quantity of materiel released if known.

(d) If the observer does not know the position of the TIC release, the event shall be reported using the NBC-4 format as described for an off target attack in accordance with

Chapter 12, Page 12-16, Change 2 to ATP-45 (A). The report shall also include Lines GOLF, HOTEL and INDIA.

(e) The chemical prediction shall use the normal NBC-3 message format. However the message will be identified as an NBC-3 ROTA with Line HOTEL indicating TIC.

D. Protection. Commanders shall ensure that NATO forces only operate in a TIC hazard area in the case of military necessity. In this instance the Commander shall insure the highest levels of personal protection are available.

(1) Protection for General Forces Evacuating a TIC Hazard Area.

(a) Respiratory Protection.

i. Military Filters. Standard issue NBC filters have only been tested for their effectiveness against known chemical warfare agents. Military filters should not be relied upon for protection against TICs. The military respirator should only be used for emergency protection against the immediate effects of a toxic release while evacuating from the immediate hazard zone. Both individual and vehicular collective filters may heat and burn when exposed to high concentrations of certain TICs.

ii. Industrial Filters. There are some industrial respirator filters available that will protect against certain levels of TIC hazard. Industrial respirators, if available, shall be used if they are specifically designed for use against an identified TIC and the measured concentration of the TIC is below the threshold of the respirator filter. As a general rule it is preferable to use these respirator filters for general troops in the area where there may be a TIC hazard.

(b) Skin Protection. When evacuating a TIC hazard area after a release, individuals shall wear clothing that will minimize injury to exposed skin. Exposed skin shall be covered, to the greatest extent feasible, to prevent deposition of liquid TICs. Normal NBC individual protection equipment could be used for this purpose.

(2) Protection for forces operating inside or in the proximity of a TIC hazard. These forces are normally reconnaissance or rescue personnel.

(a) Respiratory protection - Self-Contained Breathing Apparatus (SCBA) is the protection of choice when individuals must operate in the area.

(b) Skin Protection - While in a TIC hazard area, individuals shall wear equipment certified for TIC use that will not allow liquid or vapors to cause injury to skin.

E. NBC Survey Reconnaissance

(1) ACE forces should avoid the TIC release hazard area as long as possible. However, if the Commander determines that ACE forces are required to operate near or within the TIC hazard area, he shall direct the conduct of an NBC Survey to determine the extent of the hazard. The ground reconnaissance team shall use protective posture as above. Additionally, the commander shall direct aerial visual reconnaissance that may provide important information on the extent of a TIC release site.

(a) The survey of the TIC hazard area is accomplished in accordance with standard, recognized chemical survey procedures. However, the survey team will only survey to determine the outside limits of the TIC hazard. Under no circumstances are they to cross

the boundary of contamination to make a complete survey. This precludes unnecessary exposure to contamination.

(b) The survey is accomplished using special TIC identification equipment. Standard military chemical detection equipment is not normally suitable for detection of TICs. The, mass spectrometer, is the only military equipment that is both suitable for TICs and is readily available in some military NBC Reconnaissance units. These units shall be used to accomplish the survey.

(c) The Commander may obtain commercial detectors such as Draeger tubes. These detectors are useful for additional extra confirmation of individual TIC compounds. Other toxic products, that originate from chemical reactions or as combustion by-products, may be present in unknown concentrations in the TIC cloud and cannot be identified by these detectors.

(2) The survey team shall subsequently mark the limits of the hazard area in accordance with STANAG 2002, "Warning Signs for the Marking of Contaminated or Dangerous Land Areas, Complete Equipments, Supplies and Stores". The team should use the Chemical marker annotating TIC as the identified agent.

(3) The survey team shall report their results using the standard NBC-4 format. However, the report is identified as an NBC-4 ROTA report. Line HOTEL will indicate TIC or the specific chemical compound detected as the type of agent in all reports. Line GOLF will indicate the source of the release. Line GENTEXT will indicate any other information about the source as applicable. All other lines of the NBC-4 report remain the same as reporting a traditional NBC-4 Chemical report.

(4) Once all survey results are completed, they shall be compiled by the operational units NBC Defense Cell. An overlay that outlines the extent of the TIC hazard shall be produced and sent via NBC-5 message to all units in the area of operations. The message shall be identified as an NBC-5 ROTA report. The report is formatted as follows:

Table 5-X: Line items from the ACE Derivative 80-64

Line	Item
Line Alpha	Strike Serial Number
Line Delta	Date Time Group of Initial Detection
Line Hotel	Type of ROTA Release (TIC or specific compound)
Line Tango	Date Time Group of Latest Survey
Line X Ray	Grid Co-ordinates indicating the outside limit of the ROTA hazard
Line Gentext	Additional Information (More detailed survey results)

(5) The NBC Defense Officer of each operational headquarters in theatre shall maintain a current list of all confined, suspected and potential TIC hazards within his area of operations. The NBC Defense Officer at the highest operational headquarters shall monitor the status of these areas and make periodic updates for issue to ACE units.

F. Decontamination - Once operations in a TIC hazard area are complete, all equipment shall be inspected for contamination. Equipment shall be segregated, marked as contaminated, and plastic wrapped for further disposition. Exposed personnel must also be examined and monitored by competent medical authorities. If contaminated, individuals shall be decontaminated using large

quantities of cold soapy water. Dry decontaminants may be used if available and they are designed for use against a specific chemical agent.

G. Establishment of Safe Area - Removal and destruction of the TIC hazard is not a military mission unless the Commander has a clear need for the facility out of military necessity. Commanders shall involve Civil-Military affairs officers once the extent of the TIC hazard is realized to ensure co-ordination is conducted with the civilian authorities for site restoration.

5.18. Smokes

1. References: FM 8-9 (Part III) and FM 3-50.
2. General. Obscurant smokes are used to hide troops, equipment, and areas from detection by obscuring vision. The smokes consist of small solid or liquid particles that intercept or diffuse the light. Most smokes are not hazardous in concentrations that are useful for obscuring purposes. However, exposure to heavy smoke concentrations for extended periods may cause illness or even death. Medical personnel should, therefore, be prepared to treat potential reactions to military smokes once such smokes have been introduced to the battlefield.
3. Physical and Chemical Properties.
 - A. Hexachloroethane Smoke (HC). HC smoke is a severe respiratory track irritant. High concentrations of HC smoke generated in confined spaces are extremely dangerous and single exposures can be lethal. The major component of hexachloroethane (HC) smoke is zinc chloride, which is generated from a mixture of hexachloroethane, grained aluminum and zinc oxide. Upon burning, the mixture produces zinc chloride, zinc oxychlorides, and HCl vapor that rapidly absorb moisture from the air to form a grayish white smoke. HC mixtures can be dispersed by several methods, including grenades, candles, smoke pots, cartridges, and air bombs. Zinc chloride is a severe respiratory tract irritant and inhalation can produce potentially fatal pulmonary edema. A protective mask must be worn whenever exposure to HC smoke is possible.
 - B. Chlorosulphonic acid (CSA). CSA is a heavy, strongly acidic liquid which, when dispersed in air, absorbs moisture to form a dense white fog consisting of small droplets of hydrochloric and sulfuric acids. In moderate concentrations it is highly irritating to the eyes, noses and skin. The respirator should be worn in all concentrations, which are sufficient to cause any cough, irritation of the eyes or prickling of the skin. A risk exists when chlorosulphonic acid comes in contact with water due to the generation of intense heat and the scattering of acid in all directions. Owing to its highly corrosive nature careful handling is required.
 - C. Titanium Tetrachloride (FM). FM is a yellow non-inflammable and corrosive fluid that on contact with damp air gives off a heavy dense white cloud. It is disseminated by aircraft for the production of vertical smoke curtains extending down to ground and sea level. The smoke consists of fine particles of free hydrochloric acid and titanium oxychloride. The smoke is unpleasant to breathe. Goggles or a respirator should be worn when the spray is falling due to the risk of droplets entering the eyes. Full protective clothing should be worn when handling the liquid to avoid contamination of eyes and skin. Liquid FM produces acid burns of the skin or eyes.
 - D. Fog Oil. Fog oil is a mineral oil similar to light weight motor oil. The smoke is generated by injecting fog oil into a heated manifold where it vaporizes and, on cooling in the airstream, quickly

recondenses. Oil mists created in this way are composed predominantly of respirable droplets. While exposures to fog oil may cause discomfort, it is acutely non-toxic except at extremely high concentrations. Repeated skin exposures may produce a mild erythema. Inhaled droplets can accumulate in the lungs and repeated inhalation can produce oil pneumonia.

E. Phosphorus. At ordinary temperatures, white phosphorus (WP) is a solid that can be handled safely under water. When dry, it burns fiercely in air, producing a dense white smoke. Fragments of melted particles of the burning substance may become embedded in the skin of persons close to a bursting projectile, producing burns which are multiple, deep and variable in size. The fragments continue to burn unless oxygen is excluded by flooding or smothering. WP may be used to produce a hot dense white smoke composed of particles of phosphorus pentoxide which are converted by moist air to droplets of phosphoric acid. The smoke irritates the eyes and nose in moderate concentrations. Field concentrations of the smoke are usually harmless although they may cause temporary irritation to the eyes, nose, or throat. The respirator provides adequate protection against white phosphorus smoke. In an artillery projectile white phosphorus is contained in felt wedges which ignite immediately upon exposure to air and fall to the ground. Up to 15% of the white phosphorus remains within the charred wedge and can re-ignite if the felt is crushed and the unburned white phosphorus exposed to the atmosphere. Red phosphorus (RP) is not nearly as reactive as white phosphorus. It reacts slowly with atmospheric moisture and the smoke does not produce thermal injury, hence the smoke is less toxic.

4. Detection. Unknown.
5. Protection. In the open air, the air passages should be protected by a respirator if the smoke irritates the airway, if it is very thick or if a stay of longer than 5 minutes in a diluted cloud is necessary. The standard respirator gives the respiratory tract and eyes adequate protection against all smokes and should always be worn when smokes are used in confined spaces. It will not, however, protect against carbon monoxide.
6. Decontamination. For fog oil- showering with soap and water and a change of clothes is sufficient.
7. Medical Effects of HC smokes. HC smoke is possibly the most acutely toxic of the military smokes and obscurants. The toxicity of HC smoke is mainly due to the formation of the strongly acidic HCl, but is also to a lesser extent due to thermal lesions. These are caused by the exothermic reaction of zinc chloride with water. The acidic HCl vapor causes lesions of the mucous membranes of the upper airways. The damage and clinical symptoms following zinc chloride exposure therefore appear immediately after the start of the exposure. However, damage to the lower airways also occurs and may result in delayed effects as chemical pneumonia with some pulmonary edema. The casualty should don his or her respirator or be removed from the source of exposure. Oxygen should be administered in cases of hypoxia. Bronchospasm should be treated appropriately, as should secondary bacterial infection. The medical effects and treatment of zinc chloride smokes are detailed in Chapter 8 of FM 8-9 (Part III).
8. Medical Effects of CSA. The symptoms are usually limited to a prickling sensation of the skin, but exposure to high concentrations or long exposures to lower concentrations as found in the field, may result in severe irritation of the eyes, skin and respiratory tract. Irrigate the contaminated eye with water or saline as soon as possible.

5.19. Flame Materials

1. References: FM 8-9 (Part III) and FM 8-285 (Chapter 10).
2. General. Incendiary agents are used to burn supplies, equipment, and structures. The main agents in this group are thermite (TH), magnesium, white phosphorus (WP), and combustible hydrocarbons (including oils and thickened gasoline). Chemical fire extinguishers containing carbon dioxide should not be used in confined spaces to extinguish thermite or magnesium types of incendiaries. When carbon tetrachloride is in contact with flame or hot metal, it produces a mixture of phosgene, chlorine, carbon monoxide, and hydrochloric acid. The standard respirator with normal canister does not protect against some agents such as carbon monoxide.
3. Thermite. Thermite incendiaries are a mixture of powdered aluminum metal and ferric oxide and are used in bombs for attacks on armored fighting vehicles. Thermite burns at about 2000°C and scatters molten metal, which may lodge in the skin producing small multiple deep burns. The wound should be cooled immediately with water and the particles removed. Afterwards the treatment is that used for other thermal burns.
4. Magnesium. Magnesium (Mg) burns at about 2000°C with a scattering effect similar to that of thermite. Its particles produce deep burns. Healing is slow unless these particles are removed quickly. Removal is usually possible under local anesthesia. When explosive charges have been added to a magnesium bomb, the fragments may be embedded deep in the tissues, causing the localized formation of hydrogen gas and tissue necrosis.
5. Detection, Protection, and Decontamination. Unknown.
6. Medical Effects of phosphorus. If burning particles of phosphorus strike and stick to the clothing, contaminated clothing should be removed quickly before the phosphorus burns through to the skin. If burning phosphorus strikes the skin, smother the flame with water, a wet cloth, or mud. Keep the phosphorus covered with the wet material to exclude air until the phosphorus particles can be removed. Try to remove the phosphorus particles with a knife, bayonet, stick, or other available object. It may be possible to remove some particles by rubbing with a wet cloth. The medical effects and treatment of phosphorus are detailed in Chapter 8 of FM 8-9 (Part III).

5.20. Hydrocarbon Fumes

1. Reference: FM 8-9 (Part III).
2. General. Fuels consist largely of hydrocarbons that may have a narcotic effect. In this respect, because of their lower volatility, diesel and paraffin (kerosene) fuels are less dangerous than petrol (gasoline). Fumes from the combustion of these fuels in internal combustion or jet engines contain a proportion of carbon monoxide, nitrous fumes, etc., which varies with the characteristics of the engine and the rate at which it is being run. The overheating of lubricant oils may result in the production of acrolein that is an aldehyde with intense irritant properties. A concentration of 5 mg.m⁻³ is immediately detectable by odor but a concentration of 50 mg.m⁻³ causes death in a short time from pulmonary edema.
3. Physical and Chemical Properties. Petrol, diesel and paraffin vapors are heavier than air and as a result of this may be encountered in fuel tanks, in vehicles or in spaces where fuels have been

stored. Hydrocarbons are inert, except when in an oxidizing atmosphere, which is capable of supporting combustion.

4. Protection. Although respirators provide full protection against these hydrocarbon fumes, there is a significant hazard from combustion products in confined spaces due to the presence of asphyxiant gases, e.g., carbon monoxide. In this case, self contained breathing apparatus is required.
5. Medical Effects of hydrocarbon fumes. Drowsiness and unconsciousness proceeding to death are encountered in severe poisoning. Less severe exposures may cause dizziness, headache, nausea, vomiting, and loss of muscular coordination. Acute emotional disturbances following hydrocarbon poisoning have been reported. Removal to fresh air is the only treatment necessary in cases of mild exposure. When severe poisoning has occurred, oxygen should be administered and positive pressure ventilation may be required. The medical effects and treatment are detailed in Chapter 8 of FM 8-9 (Part III) and FM 8-285.

5.21. Herbicides

1. Reference: FM 8-9 (Part III).
2. General. A herbicide is any preparation used to kill or inhibit the growth of plants. The term includes defoliants, desiccants, plant growth regulators, and soil sterilants. Militarily, herbicides have been used against forest croplands and brush along roads and rivers and around military establishments. There is very little likelihood of human beings or animals being poisoned as a result of dioxin-free non-cropland vegetation control. In spraying operations from aircraft, flagmen and women on the ground probably receive relatively high doses, yet a serious case of acute herbicide poisoning has never been confirmed. Poisoning may, however, result from accidental or suicidal ingestion of large quantities of undiluted herbicides.
3. 2,4-D and 2,4,5-T. Ingestion of a toxic dose of 2,4-D causes gastroenteric distress, diarrhea, mild CNS depression, dysphagia, and possibly transient liver and kidney damage. Some people have developed neuropathy as a result of skin contact with the compound. Some hours after exposure to the 2,4-D ester or the dimethylamine salt, pain, paraesthesia, and paralysis may develop. The signs and symptoms of 2,4,5-T poisoning are probably similar to those of 2,4-D poisoning. If a toxic dose of 2,4-D or 2,4,5-T has been ingested, further absorption should be prevented by gastric lavage or inducing emesis and administration of activated charcoal. Supportive therapy should be given. Additional information about 2,4-D and 2,4,5-T is found in Chapter 9 of FM 8-9, Part III.
4. Cacodylic Acid. Ingestion of a toxic dose of cacodylic acid by humans may cause slight burning of the mouth and throat, gastroenteric pain, vomiting, diarrhea, hematuria, albuminuria, dehydration, jaundice, oliguria, and collapse. CNS symptoms (headache, dizziness, and hyperexcitability) may be present, obscuring gastroenteric complaints. Shock may develop as a consequence of paralysis and increased permeability of the capillaries. Following ingestion of a toxic dose of cacodylic and further absorption should be prevented by gastric lavage, emesis, or activated charcoal. Fluids should be given to combat dehydration. Additional information about Cacodylic Acid is found in Chapter 9 of FM 8-9 (Part III).

5. Picloram. Picloram (4-amino 3, 5, 6-trichloropicolinic acid) is one of the constituents of Compound 2. The major constituent is 2, 4-D. Based on the criterion that an acute oral toxicity of 5000 mg.kg-1 or greater in warm-blooded animals is non-toxic, picloram would be rated accordingly, and Compound 2 would be rated as mildly toxic. Should ingestion of a toxic dose of picloram occur, further absorption should be prevented by gastric lavage or emesis and by administration of activated charcoal, together with supportive therapy. Washing with soap and water in the event of accidental exposure is recommended. The eyes should be washed thoroughly with water in the event of contamination. Additional information about Picloram is found in Chapter 9 of FM 8-9 (Part III).

6 LASERS AND RADIOFREQUENCY

Table of Contents

6.1.	Expertise _____	6-2
6.2.	Recognition and Identification of Laser Hazards _____	6-2
6.3.	Medical Operations - Laser Injuries _____	6-3
6.4.	Laser Technical Information _____	6-5
6.5.	Medical Effects, Symptoms, and Treatments of Laser Injuries _____	6-10
6.6.	Preventing Laser Injuries _____	6-18
6.7.	Recognition and Identification of Radiofrequency Hazards _____	6-22
6.8.	Radiofrequency Technical Information _____	6-23
6.9.	Medical Effects, Symptoms, and Treatments of Radiofrequency _____	6-24

List of Tables

Table 6-A:	Laser Classification Scheme _____	6-7
Table 6-B:	Common Laser Wavelengths _____	6-8
Table 6-C:	Army Fielded Laser Systems _____	6-8
Table 6-D:	Army Fielded Laser Systems _____	6-9
Table 6-E:	Symptoms, Signs, Diagnosis, and Treatment of Laser-Induced Injuries _____	6-15
Table 6-F:	Aidman Screener Evacuation Criteria _____	6-16
Table 6-G:	Radiofrequency Bands and Spectral Designations _____	6-24

List of Figures

Figure 6-A:	Red Cross Eye-Injured Soldier _____	6-4
Figure 6-B:	Electromagnetic Spectrum _____	6-5
Figure 6-C:	Irradiance _____	6-6
Figure 6-D:	Divergence _____	6-7
Figure 6-E:	Anatomical Structure of the Eye _____	6-9
Figure 6-F:	Wavelength effects on the eye _____	6-12
Figure 6-G:	Laser Injury Evaluation Matrix _____	6-16
Figure 6-H:	Visual Acuity Chart _____	6-17

Figure 6-I:	Amsler Grid _____	6-17
Figure 6-J:	B-LPS _____	6-21
Figure 6-K:	SPECS _____	6-21
Figure 6-L:	Goggles, Sun, Wind, and Dust _____	6-21
Figure 6-M:	40/M42 Laser/Ballistic Outsert (LBO) _____	6-21

6.1. Expertise

1. US Army Medical Research Detachment at Brooks AFB can provide assistance in the medical effects, symptoms, and treatment of both laser and radiofrequency injuries. This detachment is part of Walter Reed Army Institute of Research (WRAIR).
2. USACHPPM can provide assistance in the identification of and the protection against laser and radiofrequency hazards.

6.2. Recognition and Identification of Laser Hazards

1. References:
 - A. FM 8-50.
 - B. Klenke, W. *Medical Implications of Lasers on the Modern Battlefield*, 1990.
 - C. Letterman Army Institute of Research, Issues in the Development of the AIDMAN SCREENER, Laboratory Note No. 90-81.
2. Introduction. The threat of laser injuries on the battlefield is both real and significant. Lasers of many types, powers, and wavelength characteristics have been integrated into and are used by most force structures of the world. The Department of Defense prohibits the use of lasers specifically designed to cause permanent blindness and supports negotiations to prohibit the use of such weapons. The main symptom of laser injury is reduction in visual acuity.
3. Threat.
 - A. Potential Employment. The rapid growth of laser science has resulted in an increased use of laser instruments in the military. Currently lasers are used on the modern battlefield for rangefinding, targeting, detection, communications, and target destruction. They are also used extensively in training to simulate live fire during force-on-force exercises and general operations. The army has devices that can accidentally permanently blind personnel; therefore, it is likely that threat forces have similar equipment. This may increase the potential for laser eye injuries on the battlefield. In the future lasers may be used as antipersonnel devices/weapons to disrupt military performance by reducing the soldiers' ability to see.
 - B. Laser Effects on Visual Performance. Lasers may interfere with vision either temporarily or permanently in one or both eyes. At low energy levels, lasers may produce temporary reduction in visual performance during critical military tasks, such as aiming weapons or flying aircraft. At higher energy levels they may produce serious long-term visual loss. Critical military functions, such as reading a map or driving, may be impossible. Furthermore, soldiers who

sustain minimal injuries or even no injury from low-energy laser exposures may develop serious psychological problems and become ineffective in the performance of their duties. Such psychological reactions may also develop among other soldiers assigned to units in which laser injuries have been reported. Such reactions could affect morale and discipline, as well as the overall ability of the unit to accomplish its assigned mission.

4. Recognition.

A. Temporary. Burns of the skin and cornea indicate that an infrared or ultraviolet laser could have been used. Significant retinal hemorrhage probably means that a pulsed laser in the visible or near-infrared portion of the spectrum has been employed. Isolated retinal burns without significant hemorrhage probably indicate the use of a visible laser in the continuous wave mode. At lower exposure levels, the visible laser can impair visual function for as long as the laser source is visible. When the laser exposure terminates, vision will recover to normal without observable changes in the structure of the eye.

B. Permanent. In these cases there are alterations of ocular tissue; they include:

- (1) Circumscribed (local spotlike) lesions of the retina.
- (2) Lesions of the retina with bleeding into the vitreous.
- (3) Severe corneal burns.

6.3. Medical Operations - Laser Injuries

1. References:

A. FM 8-50 and FM 8-55.

B. Textbook of Military Medicine, Part III, Volume 2, Chapter 15, Nonionizing Radiation, 1993.

C. Letterman Army Institute of Research, Issues in the Development of the AIDMAN SCREENER, Laboratory Note No. 90-81.

D. Letterman Army Institute of Research, Psychological Effects of Lasers on the Battlefield: Issues and Ideas, Institute Report No. 246.

2. Directed Energy Weapons. Directed-energy weapons are likely to cause large numbers of casualties and equipment disruptions if countermeasures are not in place. Health service support units have adequate organization, doctrine, and resources to address low-level lasers.

3. Evacuation.

A. Criteria. The capability for medical evacuation, the intensity of the battle, tactical need, and the patient will determine if he will be evacuated or will remain engaged. A visual function assessment, as well as other findings such as hemorrhage, will be used to determine the soldiers' duty status. The combat lifesaver and combat medic must consider the soldier's need for evaluation by a physician/PA (to include an ophthalmoscopic examination). From this information, one can determine the need for evacuation of the patient. Ground ambulance is the preferred method of evacuation; the lack of urgency for treatment does not justify aeromedical evacuation. See FM 8-10-6 for additional information on evacuation.

B. Guidance. The situation will dictate the evacuation policy. The International Red Cross Eye-Injured Soldier Chart (Figure 6-A) is a reproduction from "A Report on the Working Group of Experts on Battlefield Laser Weapons" by the International Red Cross. A *Type A* ocular injury is considered to be an extrafoveal lesion while a *Type B* ocular injury is considered to be a foveal lesion.

Figure 6-A: Red Cross Eye-Injured Soldier

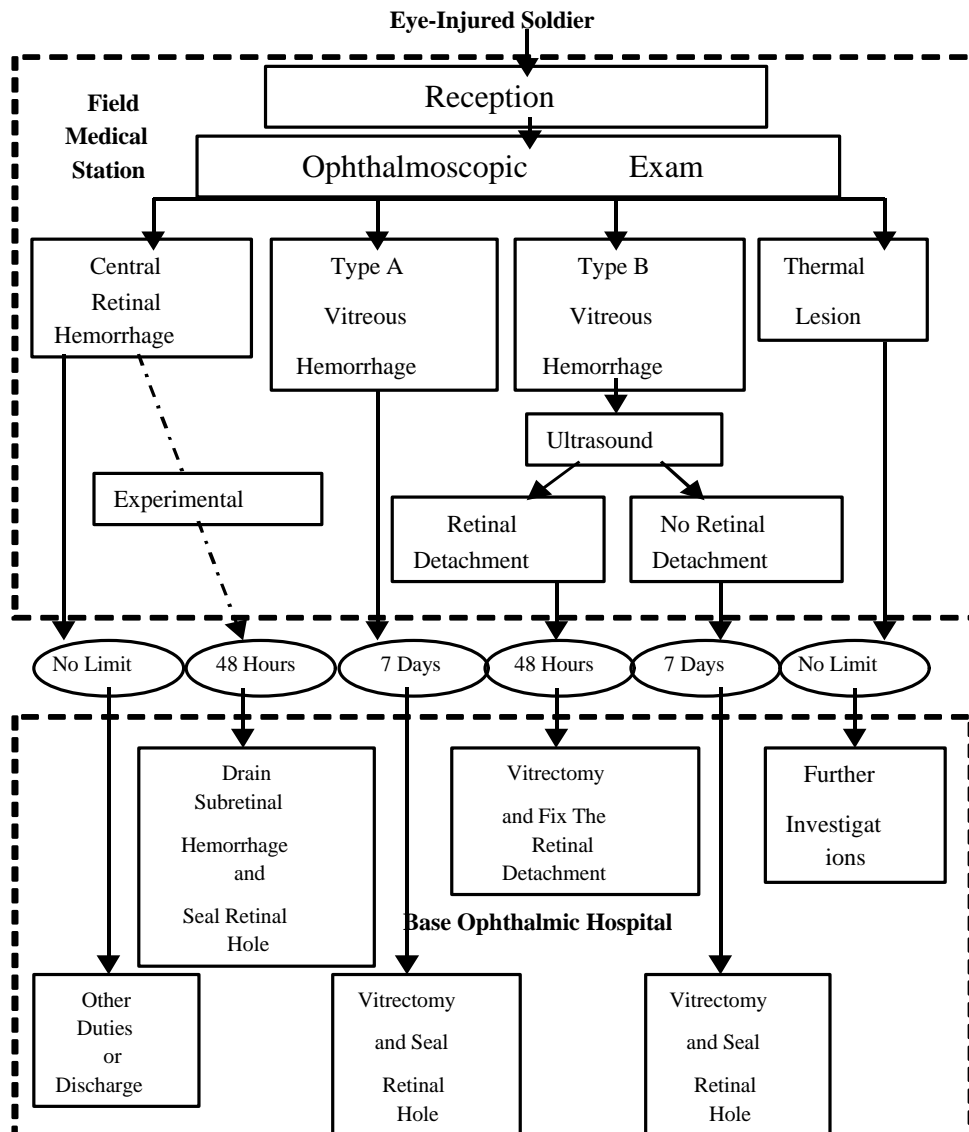

Reference: Letterman Army Institute of Research, Issues in the Development of the AIDMAN SCREENER, Laboratory Note No. 90-81

6.4. Laser Technical Information

1. References:
 - A. FM 8-50 and FM 8-55.
 - B. Textbook of Military Medicine, Part III, Volume 2, Chapter 15, Nonionizing Radiation, 1993.
 - C. American National Standard for the Safe Use of Lasers, ANSI Z136.1, 1993
2. Introduction. The word "**LASER**" is an acronym for "**L**ight **A**mplification by **S**timulated **E**mission of **R**adiation." A laser is a device that produces an intense, narrow, and monochromatic beam of light. Several key laser parameters are the wavelength, the power density, and the divergence of the radiation. The effects produced by laser radiation are dependent on the laser radiation exposure dose. The higher the exposure dose, the more severe the effects. Lasers emit radiant energy in several modes
 - (1) In a continuous wave (CW), such as an automobile headlamp.
 - (2) In a single pulse of short duration, such as a flashbulb.
 - (3) In a repetition of short pulses, such as a strobe light.

Figure 6-B: Electromagnetic Spectrum

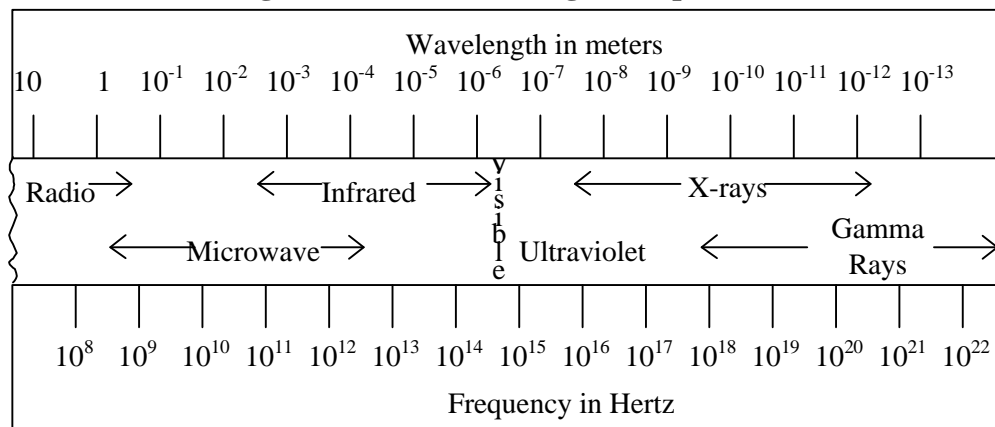

Reference: Textbook of Military Medicine, Part III, Volume 2, Chapter 15, Nonionizing Radiation, 1993.

3. Laser Wavelength. Lasers generally produce radiation (light) in the ultraviolet, visible, near infrared and far infrared portions of the spectrum (see Figure 6-B). The wavelength of the radiation depends upon the type of laser. For example, a CO₂ laser produces radiation in the far infrared (10.6 μm radiation) while a ruby laser produces radiation in the visible (red light). The laser wavelength is one of the critical parameters in determining the effects a laser will have on an object such as an eye.

4. **Laser Power and Irradiance.** The power emitted from a laser is expressed in units of energy per unit of time, referred to as the radiant power. Power is expressed in watts, where one watt is equal to one joule (a unit of energy) per second. A one-watt laser emits 1 joule of energy in 1 second, or 2 joules of energy in 2 seconds. Some lasers, particularly laser rangefinders and target designators, emit energy in a very brief period of time (billionths of a second). A typical laser rangefinder emits 60 millijoules (60×10^{-3} joules) of energy in a 20 nanosecond (20×10^{-9} seconds) pulse. The irradiance is expressed in power per unit area, watts/cm^2 (see Figure 6-C). The laser irradiance is one of the critical parameters in determining the effects a laser will have on an object such as an eye.

Figure 6-C: Irradiance

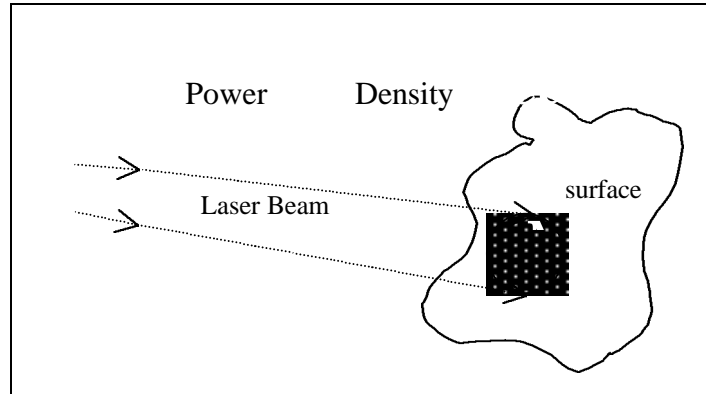

5. **Laser Divergence.** The divergence of a laser is a description of how fast the beam spreads out over distance. It is expressed as an angle and given in milliradians. For a typical military laser, the laser beam is 1 meter in diameter at a distance of 1 kilometer, and 2 meters in diameter at a distance of 2 kilometers. The divergence of such a laser would be 1 milliradian (see Figure 6-D).
6. **Laser Classification.** Army lasers are generally classified by the ability of the primary or reflected primary laser beam to do biological damage to the eye or the skin during intended use. The American National Standard for the Safe use of Lasers (ANSI Z136.1) is the primary army reference for laser classification. The class of the laser is a good reference for estimating the possible biological damage (see Table 6-A).
7. **Common Laser Wavelengths.** Lasers can produce radiation in the ultraviolet, visible, and infrared regions of the spectrum. Table 6-B lists several common laser lines and the medium used to produce the laser.
8. **Army Laser Systems.** Lasers perform a variety of functions and come in many shapes and forms. Dangerous lasers can be smaller than a pen or larger than a truck and every size and shape in between. Table 6-C lists several army-fielded systems. Several systems, such as the AN/VVG-2, are almost entirely phased out of the US Army inventory. They may, however, be found in foreign militaries or in National Guard or reserve units. The Nominal Ocular Hazard Distance and the Optical Distance should only be used as a general guide. Specific questions need to be addressed to the USACHPPM.

Figure 6-D: Divergence

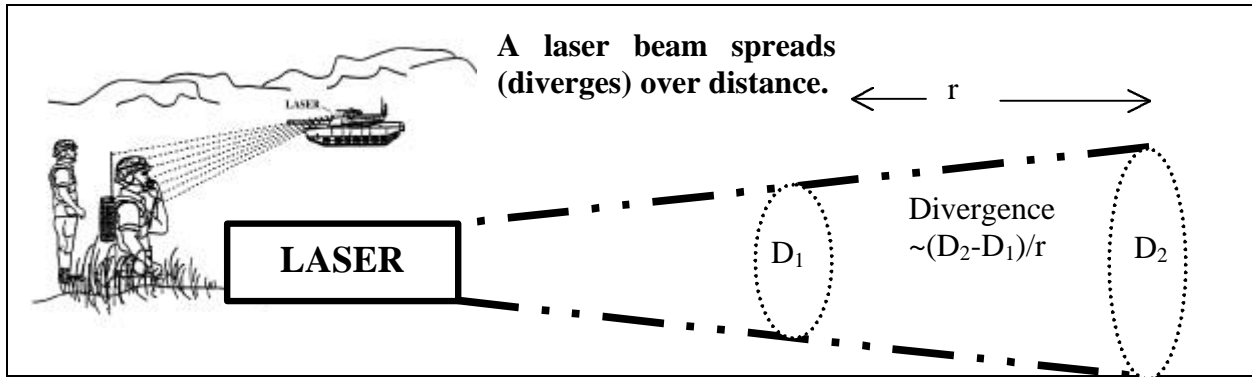

Table 6-A: Laser Classification Scheme

Class	Energy	Hazards
Class 1	Depends on wavelength. Example: CW HeNe (632 nm) below 0.0068 mW	Incapable of producing damaging radiation
Class 2 (visible lasers only)	Depends on wavelength. Example CW visible lasers: Cannot exceed 1 mW	Eye protection is normally afforded by the aversion response (0.25 sec for visible) Hazards comparable to projectors or the sun
Class 3 (3a and 3b)	CW and repetitively pulsed lasers: cannot exceed 0.5 W for 0.25 sec Pulsed lasers: Cannot exceed 0.125 J within 0.25 sec	Direct and specular reflection viewing hazards Diffuse reflection is usually not a hazard
Class 4	Average power above 0.5 W Pulsed lasers: Exceeds 0.125 J within 0.25 sec	Direct and specular reflection viewing hazards Diffuse reflection may present a hazard May pose a fire hazard May generate plasma radiation

Reference: ANSI Z136.1-1993.

Table 6-B: Common Laser Wavelengths

CIE band	Wavelength (nm)	Medium	Typical Operation
UV-A	327	Nitrogen	Pulse-train
UV-A	350	Argon	CW
Visible light	441.6	Helium-Cadmium	CW
Visible light	458,488,514.5	Argon	CW
Visible light	568,647	Krypton	CW
Visible light	530	Nd frequency-doubled	Pulsed
Visible light	511-578	Copper vapor	Pulse-train
Visible light	632.8	Helium-neon	CW
Visible light	694.3	Ruby	Pulsed
Visible light	560-640	Rhodamine 6G dye	CW/Pulsed
IR-A	700-800	Alexandrite	Pulse-train
IR-A	850	GaAlAs	Pulse-train
IR-A	905	Gallium-arsenide	Pulse-train
IR-A	1060	Neodymium:glass	Pulsed
IR-A	1064	Neodymium:YAG	Pulsed
IR-A	2900	Hydrogen fluoride	Pulsed
IR-A	3900	Deuterium fluoride	Pulsed
IR-C	5,000, 10,600	Carbon monoxide	CW

Reference: Table A-1 from FM 8-50.

Table 6-C: Army Fielded Laser Systems

Nomenclature	Type	Description
ACP-1	Pointing Laser	Air Commanders Pointer, Glove mounted
AIM-1	Aiming and Pointing Laser	GCP, Ground Commanders Pointer, handheld
AN/ASQ-170	Laser Designator	TADS, mounted on AH-64
AN/GVS-5	Laser Range Finder	Handheld, Looks like a binocular
AN/PAQ-1	Laser Designator	One man, Looks like a rifle
AN/PAQ-3	Range Finder / Designator	Tripod Mounted, MULE
AN/PEQ-1	Marker	Handheld, SOFLAM
AN/PEQ-2 /2A	Aiming and Pointing Laser	Aiming Laser, Small Arms mounted
AN/PVS-6	Laser Range Finder	Handheld, MELIOS Looks like a binocular
AN/TVQ-2	Range Finder / Designator	G/VLLD, tripod or vehicle mounted
AN/VVG-1	Laser Range Finder	Mounted on M551 Sheridan
AN/VVG-2	Laser Range Finder	Mounted on M60A3
AN/VVG-3	Laser Range Finder	Mounted on M1
AVENGER	Laser Range Finder	HMMWV mounted
LAAT	Laser Range Finder	Mounted on AH-1F
LPL-30	Pointing Laser	Long Range Laser Pointer
MILES	Training	Various Training Lasers
MMS	Laser Range Finder	MMS, Mast Mounted Sight on OH-58D

Reference: USACHPPM.

Table 6-D: Army Fielded Laser Systems

Nomenclature	Wavelength	Nominal Ocular Hazard Distance / Nominal Ocular Hazard Distance with optics	Optical Density / Optical Density with optics	Laser Class
ACP-1	800-900 (NIR)	.5 / 1	1.5 / 1.5	3b
AIM-1	800-900 (NIR)	.5 / 1	1.5 / 1.5	3b
AN/ASQ-170	1064 (NIR)	26 / 62	3.6 / 5.0	4
AN/GVS-5	1064(NIR)	2.7 / 13	3.7 / 4.2	3b
AN/PAQ-1	1064(NIR)	7.7 / 22	4.9 / 5.8	4
AN/PAQ-3	1064 (NIR)	20 / 53	3.3 / 5.6	4
AN/PEQ-1	1064 (NIR)	12 / 40	3.8 / 5.1	4
AN/PEQ-2 /2A	800-850 (NIR)	.2 / 1	2.2 / 2.2	3b
AN/PVS-6	1540 (NIR)	0 / 0	0 / 0	3a
AN/TVQ-2	1064 (NIR)	25 / 80	3.8 / 5.5	4
AN/VVG-1	694 (VIS)	8 / 30	5.8 / 5.8	4
AN/VVG-2	694 (VIS)	8 / 30	5.5 / 5.5	4
AN/VVG-3	1064 (NIR)	25 / 35	4.0 / 4.7	3b
AVENGER	10600 (FIR)	Corneal Hazard/NA	Corneal Hazard/NA	3b
LAAT	1064 (NIR)	5 / 30	3.5 / 4.5	3b
LPL-30	800-850 (NIR)	.1 / .7	1.3 / 1.3	3b
MILES	Generally 905 (NIR)	Variable	Variable	3a
MMS	1064 (NIR)	35 / 75	4.5 / 5.7	4

FIR: Far Infrared Radiation, NIR: Near Infrared Radiation, VIS: Visible Radiation

Reference: USACHPPM.

Figure 6-E: Anatomical Structure of the Eye

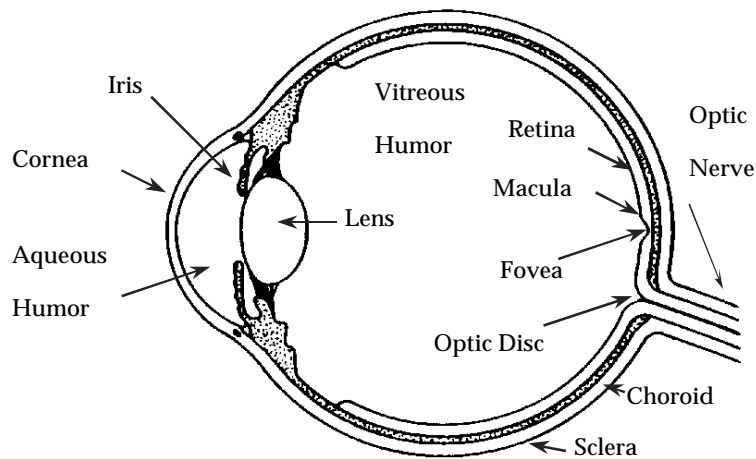

Reference: Modified from FM 8-50.

6.5. Medical Effects, Symptoms, and Treatments of Laser Injuries

1. References:
 - A. FM 8-50.
 - B. Textbook of Military Medicine, Part III, Volume 2, Chapter 15, Nonionizing Radiation, 1993.
 - C. Letterman Army Institute of Research, Issues in the Development of the AIDMAN SCREENER, Laboratory Note No. 90-81.
 - D. Letterman Army Institute of Research, Psychological Effects of Lasers on the Battlefield: Issues and Ideas, Institute Report No. 246.
2. Introduction. Exposure or even suspected exposure to a laser could have several adverse effects. The effects include severe vision problems, skin burns, and psychological reactions. The skin is susceptible to laser damage. However, the damage threshold is much higher than the eye. Psychological reactions can be severe, but training and education can significantly reduce them. The eyes are extremely vulnerable to laser damage. Imaging systems such as the human eye increase the irradiance or radiant exposure of collimated laser light at the image plane, such as the sensory retina for the human eye. For visible and near-infrared laser exposure of the human eye, the radiant exposure at the retina can be 100,000 times greater than that at the cornea or the skin surrounding the eye due to focusing or imaging by the eye. Laser emission is generally well collimated; that is, the diameter of the beam increases very little with distance (low divergence). Thus the energy contained in the beam diminishes only slightly over great distances. When taken in combination, low divergence of a laser emission and the increased radiant exposure due to ocular focusing means that low-powered lasers, such as rangefinders, pose little hazard to the skin at short ranges, but pose significant eye hazards at tactical ranges. Optical instruments such as binoculars or day sights increase light-collecting capabilities, thereby increasing the radiant exposure at the image plane. This increases the range at which eye injuries can occur. For visible lasers, this focusing results in seeing extremely bright light at distances that exceed anticipated eye injury ranges.
3. Injuries. Injuries result when the energy from the laser is absorbed by various anatomical structures. The most vulnerable structure is the eye (Figure 6-E), but other structures, such as the skin, can also be affected. The wavelength of the laser radiation determines which structure absorbs the energy. The power density of the laser determines the damage level.
4. Laser Ocular Biology. The biological effects of laser radiation on the eyes vary with the laser wavelength, pulse duration, and intensity. The cornea and lens focuses visible and near-infrared laser radiation onto the retina where the concentrated energy directly impacts the photoreceptor cells and supporting tissue. The cornea and lens absorb ultraviolet and mid-to-far-infrared laser radiation. Alteration can occur in these tissues, but the retina will be spared.
 - A. Retina. The retina is the back inside of the eye where images are formed. During laser exposure of the retina, no image is formed and all energy is simply focused to a pinpoint. A laser exposure occurring in the retinal periphery will have a minimal effect on normal vision functions (unless large portions of the retina are involved). A laser exposure in the central retina

(about 1.5 mm and called the macula which includes the fovea) can cause serious injury since this is the only part of the eye where precise vision occurs.

(1) At the lowest levels of laser energy, temporary changes in the ability to see can be produced without permanent damage. Continuous or repetitively pulsed visible wavelength lasers can produce veiling glare while the laser is on, but disappear when the laser is turned off. The laser simply appears so bright that it is difficult to see anything else around it. At slightly higher energy, these same lasers can saturate the photoreceptor cells. This saturation results in after-imaging that fades with time after the laser is turned off. Only visible lasers will produce veiling glare and after-images; near-infrared lasers will not produce these effects even though the laser energy reaches the photoreceptor cells. It is important to note that these effects can also be caused by other bright light sources, such as searchlights, flares, and strobes. Further increases in laser energy levels result in irreversible retinal damage. Absorbed energy heats the retinal tissue and is spread by thermal conduction. The heat causes thermal coagulation of the photoreceptor cells and other retinal structures. Inflammatory processes and edema will threaten the surrounding retina. These processes result in scotomas (blind spots) which vary in size, depending on the extent of the retinal damage. The effect of the scotoma on visual function will vary with the size and position. For example: A small burn away from the fovea may not significantly disturb vision acuity. A small burn centered on the fovea may result in a severe loss in visual acuity (this injury would appear as a large blind spot in the center of the visual field). The fovea is the part of the retina with the highest visual acuity. The visual acuity of the fovea is high enough to allow humans to read. When the fovea is damaged, the person experiences severe loss of vision

(2) When the retina is exposed to a high energy pulsed laser energy, the tissue is superheated and undergoes an explosive change of state, creating shock waves, which mechanically disrupt tissue and spread the area of damage. If more energy is introduced, the injured area will become larger. The mechanical force produced can puncture a hole through the retina and choroid, resulting in hemorrhaging and may lead to severe visual loss. The blood can collect beneath the photoreceptor cell layer of the retina, disturbing its contact with the retinal pigment epithelium resulting in retinal detachment. A subretinal hemorrhage can result in the death of the photoreceptor cells and a scotoma will form that is much larger than the thermal burn or mechanical disruption. The blood may also move into the vitreous humor through the disrupted retina, where it may obstruct the passage of light through the eye. An extensive or centrally located hemorrhage can produce a significant loss of vision. Blood in the vitreous is absorbed very slowly, but in most cases it is absorbed. The visual impairment remains as long as the blood persists; vision may improve to normal with absorption of the blood. Persistent vitreal hemorrhages may be removed by a complicated surgical technique called Vitrectomy. This procedure may also return vision to "near normal" level, if the underlying retinal/choroidal damage does not involve the fovea.

(3) Laser injury to the retina may damage the conducting fibers (axons) of the retina, producing a visual field defect peripheral to the site of injury. Laser damage to the retinal/choroidal areas may produce brief, severe pain. A major long-term effect of laser retinal injury is a scarring process that may degrade vision weeks or even months after the injury.

B. Cornea. The cornea is the transparent front part of the eye that separates it from the air. The cornea is continuous with the sclera (white of the eye). The cornea transmits most laser wavelengths except for the ultraviolet and far-infrared radiation.

(1) Ultraviolet and low energy far-infrared radiation can injure the epithelial layer of the cornea; a condition that is painful and visually handicapping. At lower powers, this injury is primarily due to a photochemical reaction. A latency period of hours may exist between the time of exposure and the development of the corneal pathology. Minimal corneal lesions, which usually produce a decrement in visual performance, heal within a few days and generally result in a full recovery. More severe corneal lesions may scar.

(2) High-energy far-infrared radiation is absorbed mainly by the cornea, producing immediate burns at all corneal layers. An infrared laser can produce a burn resulting in immediate visual incapacitation and may lead to cornea scarring. Very high energy can perforate the cornea; this perforation may lead to loss of the eye.

5. Biological Effects due to Laser Wavelength. Injuries result when the energy from the laser is absorbed by various anatomical structures. The most vulnerable structure is the eye, but other structures, such as the skin, can also be affected. The wavelength (frequency) of the laser radiation determines which structure absorbs the energy (see Figure 6-F).

Figure 6-F: Wavelength effects on the eye

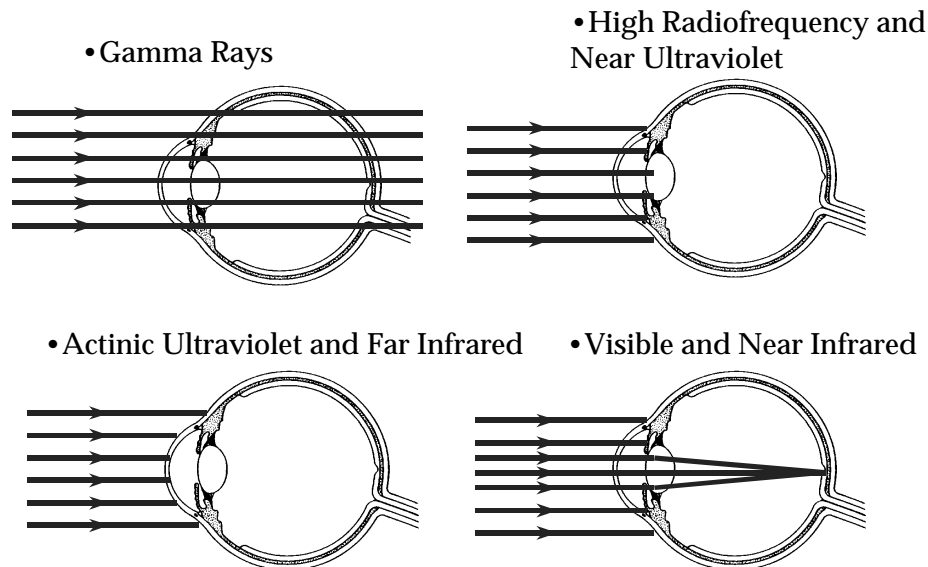

Reference: Modified from FM 8-50.

A. Ultraviolet (UV) Radiation (180 - 400 nanometer (nm), UV-A, B, C). The primary hazards from this wavelength range are damage to either the lens or the cornea of the eye. Long term low level and short term high level exposures can cause corneal and lens opacities (cataracts) or inflammation of the eye. UV radiation can also cause photokeratitis, which is sunburn of the cornea. The threshold for ultraviolet radiation skin burns is similar to that of the cornea.

B. Visible Light (400 - 760 nm) and Near-Infrared (IR-A) Radiation (760 - 1400 nm). The primary hazard from this wavelength range is damage to the retina, including the macula and fovea, of the eye. Depending on the level of exposure, the damage may be temporary or

permanent. Laser radiation in the visible spectrum (400-700 nm) is absorbed primarily within the retina by the pigment epithelium and the choroid. The threshold for skin burns for visible and near-infrared radiation is much higher than that for the retina.

C. Far-Infrared Radiation (1,400 nm - 1 mm). Absorption of radiation in this range will result in the production of heat with the resultant effects on both the cornea and the lens of the eye. The threshold for far-infrared radiation skin burns is similar to that of the cornea.

6. Psychological Effects (including stress). Several aspects of the laser threat increase mental stress relative to that produced by other weapons. The fact that lasers travel at the speed of light along line-of-sight gives a new urgency to the saying "If you can be seen, you can be hit." This may produce the types of psychological stress reactions and inhibitions of combat initiative, which have been described in response to sniper fire. However, unlike the sniper's bullet, most lasers produce serious injury only to the extent that the target is looking at the laser source and/or through optical equipment. Because the danger is so specific, soldiers may be especially inhibited from performing critical surveillance, target acquisition and aiming tasks. This is especially likely if they have just seen their fellow soldiers suffer the effects of laser while performing those tasks. It is inevitable that at least some soldiers will suffer laser injuries to their eyes. The reaction of the injured soldiers and their comrades will depend on:

- A. Their response to the stress of a new, silent, futuristic weapon on the battlefield.

- B. Their training and knowledge about laser weapons.

- C. The treatment they receive after being wounded. Laser injuries may be especially stressful; vision is one of our primary means of relating to the world about us; and the fact or prospect of being deprived of vision will be a source of fear. The soldier's colleague who has been accustomed to seeing external wounds of combat may have some reluctance to accept a disabling injury without outward evidence. Yet looking at the world through his own blood as a result of laser-induced retinal hemorrhage may cause panic in the afflicted soldier and terror in his companion.

7. Laser Injury Treatment.

- A. Stress. Medical management of stress reactions for patients suffering from real or imagined laser injuries is similar to stress management of other injuries. Repeat the reassurance that symptoms will improve with rest, nutrition, hygiene, and the expectancy of an early return to the soldier's unit. For specific combat stress control procedures, see FM 8-51.

- B. Burns. Far-infrared laser burns of the cornea and skin are treated similarly to other types of thermal burns. If not perforated, apply antibiotic ointment to the eye then patch. The patient should also receive systemic broad-spectrum antibiotics coverage and systemic analgesic. There is very little likelihood of an isolated eye burn; the eyelids, skin of the face, and other parts of the body will be affected and should be treated (see FM 8-230 for treatment of burns).

- C. Retinal Injuries. Currently, there is no proven treatment of laser retinal lesions except for surgical intervention (vitrectomy) for severe hemorrhage. A patient diagnosed with a laser retinal injury is evacuated to a hospital where he can be examined by an ophthalmologist. A vitrectomy consists of removing the vitreous of the eye and the hemorrhage. This procedure can only be performed in a hospital by a specially trained ophthalmologist. Retinal burns do not require eye patches. They only make the patient more disabled by taking away all of his vision; thus, further emphasizing his injury.

D. Corneal Injuries. For laser burns to the cornea, only the injured eye is patched, after applying eye ointment. Do not patch both eyes unless both have been burned.

8. Symptoms. The main symptom of laser injury is reduction in visual acuity; another symptom may be pain. Medical personnel should suspect laser exposure when soldiers report seeing bright flashes of light; experiencing eye discomfort and poor vision; and feeling unexplained heat. Obvious lesions such as corneal burns, retinal injury and hemorrhage, and skin burns make the diagnosis more certain. Conceivably, one may confuse the use of invisible lasers with chemical agents that also irritate the eyes and skin (see FM 8-285 for signs and symptoms of chemical agent injuries). Spontaneous fires and unexplained damage to optical instruments are additional evidence that laser devices/weapons are being employed. Table 6-E lists symptoms, signs, diagnosis, and treatment of laser induced injuries.
9. Evaluation of Suspected Laser Injuries. Evaluation of possible laser injuries requires a search for specific findings on physical examination. The medic must determine quickly if the affected soldier is fit to return to duty or if he should be referred to the battalion aid station for further evaluation and/or treatment. The combat lifesaver and combat medic laser eye injury evaluation matrix (Figure 6-G) is a reproduction from FM 8-50.
10. Aidman Vision Screener. The aidman vision screener is an informal test that can be used to assess the function of the eye by an army medic. The test(s) are function based and result in evacuation recommendations. The tests consist of a near visual acuity test, such as a random E chart or Snellen chart (Figure 6-H), and an Amsler Grid (Figure 6-I) visual field test. For soldiers who report being exposed to a laser source, the aidman screener offers a quick laser injury recognition tool (Table 6-F).

Table 6-E: Symptoms, Signs, Diagnosis, and Treatment of Laser-Induced Injuries

Symptoms (Reported by patient)	Signs (Findings on examination)	Diagnosis (and likely laser etiology)	Treatment and Management
Skin and Anterior Eye Injuries			
Reduction in vision. Pain in eye, eyes tender. Red or warm face or skin.	White or hazy cornea. Conjunctival inflammation. Facial or skin erythema.	Mid-moderate corneal and/or skin burn. (Infrared laser, intermediate dose.)	If eye perforation is not suspected, apply topical antibiotics (ointment). Patch. Systemic antibiotics and pain medication*
Profound loss of vision. Severe pain in eyes. Burning sensation of face/skin.	Corneal ulceration or loss of corneal tissue. Perforation of globe. Skin burn.	Severe corneal and/or skin burn. (Infrared laser, high dose.)	Needs physician/PA** evaluation. Evacuate as appropriate.
Retinal Injuries			
Temporary loss of vision. Bright light experience. No pain.	External exam: normal. Internal exam: normal.	Glare, dazzle, or flash-blindness. (Low dose laser.)	None. Return to duty.
No or slight visual impairment. Dark spot in field of vision.	External exam: normal. Internal exam: Non-foveal retinal lesion(s).	Small non-foveal, retinal burn with no or minimal hemorrhage (visible or near-infrared laser, low to medium dose).	None. Return to duty if able to function.
Vision impaired. Large dark spot at or near center of vision.	External exam: normal. Internal exam: foveal retinal lesion(s).	Peri-foveal retinal butn, and/or hemorrhage (visible or near-infrared laser, medium dose).	Evacuate. Needs physician/PA evaluation.
Severe visual impairment. Large dark spot at or near center of vision. Large floating objects in eye. May see blood.	External exam: normal. Internal exam: foveal retinal lesion(s) that may be obscured by vitreous hemorrhage.	Foveal retinal burn, with vitreous or subretinal hemorrhage (Visible or near-infrared laser, high dose).	Evacuate. Needs physician/PA evaluation. *
*Oral aspirin or intramuscular analgesics may be used as needed. Topical anesthetics such as tetracaine are never prescribed, but may be used on a one-time basis only to aid examination. Repeated use of topical anesthetics may predispose to further corneal injury.			
**The optometrist at the MSMC may be consulted on questionable cases.			

Reference: Table 1 from FM 8-50.

Figure 6-G: Laser Injury Evaluation Matrix

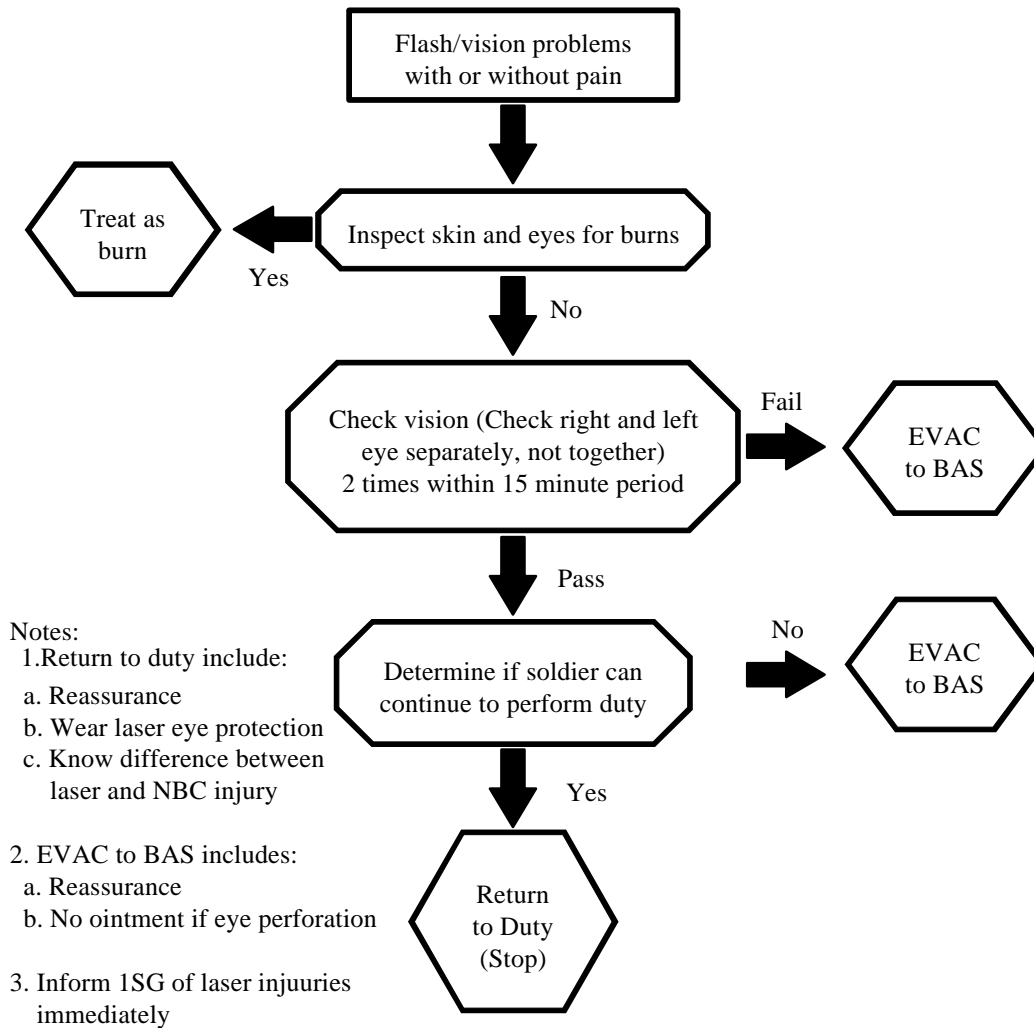

Reference: FM 8-50.

Table 6-F: Aidman Screener Evacuation Criteria

		Amsler Grid Result		
		Normal	Minor Defect	Major Defect
Visual Acuity	20/70 or worse in one or both eyes.	Evacuate	Evacuate	Evacuate
	20/50 or better in both eyes.	Return to Duty	*	Evacuate
* - If soldier indicates he can do his job, Return to Duty. If soldier indicates his vision is too poor to do his job, Evacuate.				

Reference: AIDMAN VISION SCREENER.

Figure 6-H: Visual Acuity Chart

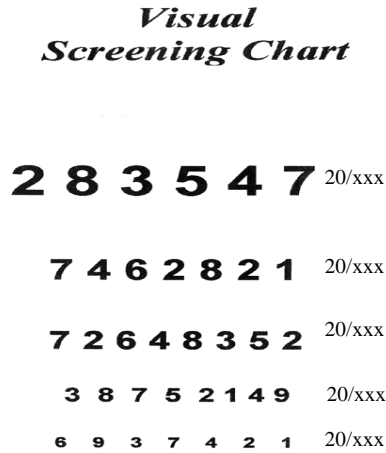

Aidman Vision Screener. Instructions for testing Visual Activity: Hold card in good light 40 centimeters, approximately 2 card lengths from eye. Test each eye individually. If the soldier normally wears glasses, these should be worn during the test. Record activity of the smallest line for which the soldier can identify the letter or the direction of 7 out of 10 characters correctly.

Reference: AIDMAN VISION SCREENER

Figure 6-I: Amsler Grid

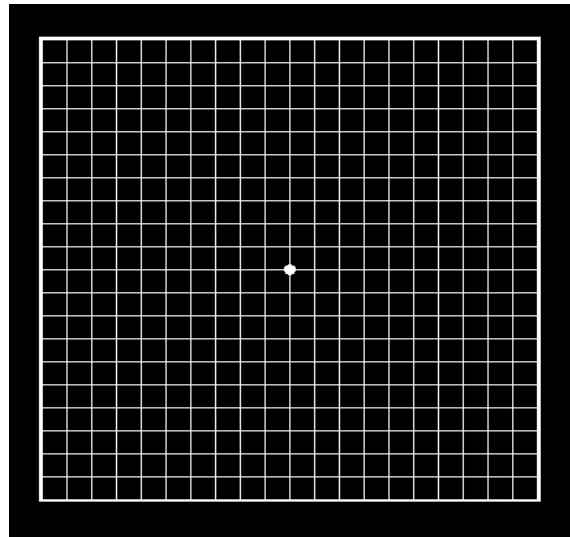

Instructions: Provide Amsler Record Chart pad for soldier to draw any irregularities. Test each eye separately in good light, reading the following:

1. Cover your left [right] eye.
2. Hold the card about 40 centimeters or two card-lengths from your eye
3. Focus on the dot in the center of the grid.
4. While continuing to focus on the center dot, do you notice any dark or hazy areas anywhere on the grid? [If the answer is YES, provide a pen or pencil and say: Please draw in the areas that appear dark or hazy to you.]
5. While still looking at the center dot, do you see all of the horizontal lines? Do these appear straight? [If the answer to either question is NO, provide a pen or pencil and say: Draw the straight lines where you think they should be.]
6. While still looking at the center dot, do you see all of the vertical lines? Do these appear straight? [If the answer to either question is NO, provide a pen or pencil and say: Draw straight lines where you think they should be.]

Intrepreting the Results: Normal- No dark or hazy areas are seen. All lines are seen and are straight. Minor defect- dark or hazy area (or abnormal lines) which is less than 4 boxes long. Major defect, dark or hazy areas (or abnormal lines) which is 4 or more boxes long or the affected area includes the center dot

Reference: AIDMAN VISION SCREENER.

6.6. Preventing Laser Injuries

1. References:
 - A. FM 8-50 and TB MED 524.
 - B. Textbook of Military Medicine, Part III, Volume 2, Chapter 15, Nonionizing Radiation, 1993.
 - C. Letterman Army Institute of Research, Issues in the Development of the AIDMAN SCREENER, Laboratory Note No. 90-81
 - D. United States Army, Soldier Systems Command (SSCOM), Intranet WEB page, <http://www-sscom.army.mil>.
2. General. Laser protective eyewear will prevent ocular injury from laser radiation emitted by low energy lasers such as rangefinders and target designators. The recently developed and fielded ballistic and laser protective eyewear (B-LPS) will protect the eye against ballistic fragments and specified fixed wavelength laser hazards. Narrow band filter eyewear made of polycarbonate ballistic-fragment-resistive material will reject specific laser wavelengths while transmitting light required for vision. The tint or color associated with laser protective eyewear may degrade vision and military performance under low light conditions; that is, dawn, dusk, or night. Current protective eyewear is designed to protect against specific laser hazards; therefore, the use of issued protective eyewear does not preclude injury to the eye from other threat laser wavelengths. Care must be taken to assure protective eyewear in use is appropriate for the laser hazard or threat present. Laser protective visors also prevent injury to the eyes with the same limitations as described for eyewear.
3. Laser Training. Laser training must provide the soldier with the knowledge to protect himself. Low energy infrared lasers can injure the eyes and/or burn the skin. Ordinary clear glass or plastic lenses or visors will protect the eye from far-infrared laser radiation such as, carbon dioxide laser radiation. Exposure to laser radiation requires line of sight; therefore, concealment, cover, or avoiding looking at a known or suspected laser threat is extremely effective for preventing injury. "DO NOT look at the light." Soldiers must be aware that protective equipment for certain laser frequencies is available; additional protection is anticipated from ongoing research. Understanding lasers requires a certain amount of technical information. As lasers become more widespread on the battlefield, the soldier may become accustomed to their use. The soldiers' fear of laser injury may increase as laser injuries increase.
4. Passive Laser Protection. Passive protection consists of:
 - A. Taking cover--get out of laser beam. Squinting can also limit the amount of laser energy that enters the eye.
 - B. Using any protective gear that is available.
 - (1) Protective goggles, visors or glasses (Figure 6-J).
 - (2) Protective built-in or clip-on filters for optical devices.
 - (3) Ordinary eyeglasses or sunglasses will afford a very limited amount of protection.
 - (4) Keep all exposed skin areas covered to prevent skin burns.
5. Active Protection. Active protection consists of using:

A. Countermeasures and countermeasure systems.

B. Maneuvers: Applying evasive action, Scanning battlefields with one eye or monocular optics, Minimizing use of binoculars in areas known to have lasers in use, Using hardened optical systems when available, and Battlefield Smoke Screen.

6. Army Laser Eye Protection.

A. Ballistic/Laser Protective Spectacles (B-LPS). The B-LPS system consists of multiple spectacle assemblies available in clear, sunglasses, two wavelength laser protection, and 3 wavelength (l) laser protection. Laser protection is provided by using dye absorber technology. The B-LPS accommodates a prescription lens insert via a nosepiece carrier for soldiers requiring corrective lenses. All lenses are ballistic protective and are capable of defeating a 5.8 grain, T-37 shaped fragment simulating projectile at 650 feet per second. The B-LPS are designed to accommodate the 5th percentile female to the 95th percentile male in one size. A hard carrying case is available that accommodates one complete spectacle assembly. Status: The improved BLPS successfully completed evaluation and was Type Classified-Standard in May 1995. Contract award for production of B-LPS was 3QFY96 and First Unit Equipped is scheduled for 4QFY98. B-LPS clear and sunglass configurations will be central fielded to Force Packages One and Two. All configurations will be available for procurement through the Defense Supply Center, Philadelphia (DSCP) after FY00. NSN number series 8465-01-416-4536,3207,3210 and NSN 8465-01-417-4004, 9963.

B. Special Protective Eyewear, Cylindrical System (SPECS). The SPECS effort was initiated in 1991, and is based on a requirement (SN-CIE) for ballistic and laser eye protection approved in 1984. The current SPECS are designed for soldiers who do not require prescription corrective lenses. The SPECS system consists of a lens carrying browbar, interchangeable spatula and cable temples, a nosepiece, and four interchangeable lenses. The temples are capable of panoscopic tilt adjustment for maximum fit, comfort, and acceptance. Lenses are available in clear, sunglass (neutral gray), two wavelength laser protection, and 3 wavelength laser protection. All lenses are ballistic protective and are capable of defeating a 5.8 grain, T-37 shaped fragment simulating projectile at 650 feet per second. The SPECS are designed to accommodate the 5th percentile female to the 95th percentile male in two sizes. A hard carrying case is available that can accommodate a complete spectacle assembly and one extra lens. Status: The SPECS successfully completed evaluation and was Type Classified - Standard in May 1995. Contract award for production of SPECS was awarded for 1QFY97, and First Unit Equipped is scheduled for 4QFY98. The SPECS kit with clear and sunglass lenses will be central fielded to Force Packages One and Two. All configurations will be available for procurement through the Defense Supply Center, Philadelphia (DSCP) after FY00. NSN number series 8465-01-416-4626, 4629, 4630, 4633, 4635, 8516, 4628, 4631, 4634, 4632, 4627.

C. Sun, Wind, and Dust Goggles. Overview: The Sun, Wind, and Dust Goggle (SWDG) is the standard military goggle, providing eye protection. It has been a standard military item since the 1950s. The goggle consists of an injection molded rubber frame with a polyurethane foam backing with a skin that contacts the face. The rubber frame holds the lens while the foam provides a seal between the face and goggle frame. The goggle is compatible with standard military prescription eyewear. Flannel covered vent holes allow some ventilation while keeping dust out. Two snap fasteners provide additional lens retention in the frame. Type 3 (clear) and type 4 (sunglass) lenses are a single piece, simple curve, injection molded polycarbonate design

with an abrasion resistant coating. Type 5 and Type 6 lenses offer laser protection. The lens (classes 3 through 6), with a nominal thickness of 2 mm, provides ballistic protection. Type 1 and 2 (thin acetate) lenses are no longer used since they offer no ballistic protection. Recent Improvements: Several improvements enhance the performance and comfort of the SWDG. Foam Pad: The foam pad, added to the rubber goggle frame in 1974, was increased in thickness to 1/2" in 1995 to provide better sealing of the goggle frame to the face. Also at this time the snap fastener was changed to facilitate easier lens replacement. Ballistic Lens: The nominal 2mm thick polycarbonate lens was type-classified in 1983 to provide ballistic protection. It replaced the thin acetate lens. Laser Lenses: Two laser protective lenses were type-classified in 1990. A two wavelength lens (Type 5), green in color, protects against neodymium and ruby lasers. A three wavelength lens (Type 6), brown in color, protects against neodymium, ruby, and double neodymium lasers. Current and Future Efforts: Advanced Protective Eyewear System (APES): The Armor School has a requirement for a new goggle system to replace the SWDG. The APES will offer improvements in comfort, fit, durability, ventilation, and fogging while maintaining equipment/clothing compatibility and ballistic protection. The APES will allow for attachment of a secondary lens in front of the ballistic lens and provide for corrective lenses. It is anticipated that this SEP program, starting in FY98, will last two years with procurement of commercial/NDI goggles during FY98. The NSNs for this item are in the category 8465-01 with the nomenclature Goggles, sun, wind, and dust.

D. MASK, CHEMICAL-BIOLOGICAL, M40/M42 SERIES LASER/BALLISTIC OUTSERT (LBO). The laser/ballistic outsert (Figure 6-M) based on proven technology from the Ballistic/Laser Protective Spectacles (B/LPS), provides protection from low speed mortar fragments and two laser wavelengths, 694 nm and 1064 nm. The outsert is made of dyed polycarbonate as the dyes provide the laser protection and the polycarbonate provides the ballistic protection. The dyes in the polycarbonate distinguish this outsert from the clear and neutral gray outserts as they cause the lens to have a green tint. As a result, the LBO has a light transmittance of 45-50% as compared to the clear, 85-90%, and neutral gray, 15-20%. The LBO can be purchased as an additional authorized list (AAL) item for the M40 and M42 series mask. However, the LBO is not compatible with the Red Hot mode of the thermal sight of the Bradley fighting vehicle. Use inside combat vehicles should be scrutinized as the outserts increase standoff distance from sights and vehicle sights may already be laser hardened. The PMCS for the LBO is similar to that of the other outserts. The NSN for the LBO is 4240-01-434-1503.

E. 50 mm Binoculars and Other Optics. Soldiers are most vulnerable when using powered optics and staring at weapons systems using lasers or at distant objects where lasers could be employed. Optics concentrates the light increasing vulnerability and staring increases the opportunity for exposure. Many weapons systems have laser protection built into the optics.

Figure 6-J: B-LPS

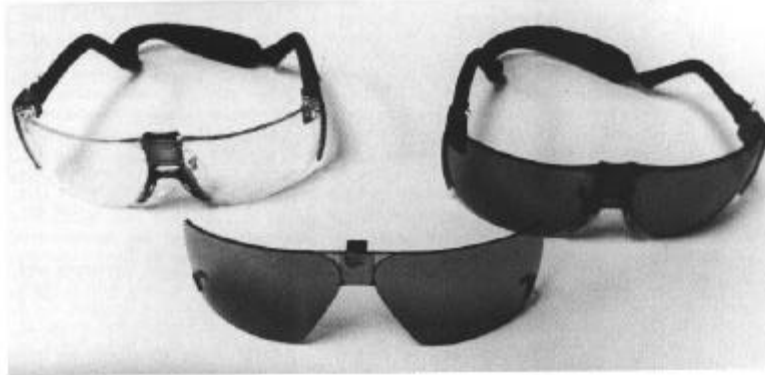

Figure 3. Protective eyewear (continued).

Reference: www-sscom.army.mil.

Figure 6-K: SPECS



Reference: www-sscom.army.mil.

Figure 6-L: Goggles, Sun, Wind, and Dust



Reference: www-sscom.army.mil.

Figure 6-M: 40/M42 Laser/Ballistic Outsert (LBO)



Reference: <http://m40mask.ml.org/m40>.

6.7. Recognition and Identification of Radiofrequency Hazards

1. References:

- A. Textbook of Military Medicine, Part III, Volume 2, 1993.
- B. USACHPPM, *Radiofrequency Radiation and Ultrasound Course Manual*, April 1997.
- C. National Council on Radiation Protection and Measurements Report No. 86, *Biological Effects and Exposure Criteria for Radiofrequency Electromagnetic Fields*, 2 April 1986.

2. Introduction. Use of Radiofrequency (RF) sources in the military is widespread and not necessarily associated with weapons systems. RF radiation is used for communication, target detection, navigation, surveillance, imaging, electronic countermeasures, therapeutic medical diathermy, medical monitoring, industrial heating, and food preparation. Although the military is experimenting with high-power sources as potential weapons, the main applications continue to be communications, information gathering, and electronic countermeasures.

3. Threat. Radiofrequency radiation has direct (thermal), indirect biological effects (athermal or nonthermal) and potential psychological effects associated with exposure or suspected exposure to individuals.

A. Direct Biological Effects.

(1) Thermal. The absorption of energy is the key mechanism by which RF radiation affects living cells directly. Deposition of RF energy into the body increases its thermal load. If the temperature increase is large enough, thermal overload of the body will result. The body's thermoregulatory system normally responds to this thermal load by transfer of energy to the surrounding environment through convection, evaporation of body water (sweating), heavier breathing, and radiation (primarily IR). If the thermal load is too great for the body to overcome, injury to the body may occur. These injuries are dependent on the frequency of the RF energy absorbed. At the higher frequencies (> 3 GHz), the skin and eyes (cataracts - clouding of the eye lens) are most susceptible. At lower frequencies, internal organs are more susceptible due to the penetration depth of the radiofrequency waves. Some individuals have also reported an audible sensation of knocking, clicking and buzzing from Super High Frequency pulsed RF energy. This is sometimes referred to as "microwave hearing" and is not a potentially hazardous effect. It should be remembered that unlike ionizing radiation, RF energy is not cumulative, unless of course the levels of exposure are so severe as to cause permanent injury. This is not likely to occur with any RF transmitting systems in the current Army inventory.

(2) RF Shock and Burns. For systems operating at less than 100 MHz, a shock and/or burn potential is also present if an individual is very close to an energized antenna or makes physical contact with the metallic portions of the antenna. The threshold for RF current perception is a function of the frequency, surface area of the contact point and individual sensitivity. If the intensity of the current density is minimal, only a shock may be perceived. If higher, an actual RF burn may result.

B. Nonthermal Effects. Nonthermal effects have been defined as physiological changes in which the core body temperature is not elevated but a quantity of energy is absorbed sufficient to activate receptors and cause a physiological response. Nonthermal effects included immune and endocrine effects supposedly stimulated by exposure to low intensity RF. Some nonthermal

effects reported in the literature have included carcinogenesis, reproductive problems, and increased permeability in the blood-brain barrier and behavioral changes. No conclusive evidence substantiates these reported effects from low low-level RF radiation.

C. Psychological Effects. Due to a lack of understanding of nonionizing radiation and RF radiation in particular, many individuals also have a fear of working near radiating sources and also erroneously suspect that certain physical ailments have been a result of RF exposure. Headaches, anxiety, nausea, dizziness, fatigue, and sunburn, etc. have frequently been blamed on perceived exposure to RF radiation. Most often these symptoms have actually resulted from dehydration, sleep deprivation, poor ventilation, and high temperature environments.

4. Recognition. If the temperature rise of the body is large enough, due to deposition of energy from the Radiofrequency radiation, thermal overload of the body will result. Exposure to radiation levels that are significantly greater than permissible exposure limits will be felt as heat to the body. At high frequencies (> 3 GHz), skin erythema may occur. At lower frequencies less than 3 GHz, nausea may occur as well as internal discomfort. Although lenticular cataracts are possible at higher frequencies, the possibility is extremely remote, as an individual would feel extreme heat on his/her face before a cataract could actually form. For RF shock, a tingling or startle reaction would be noticeable. For an RF burn, a 3rd degree burn to the skin could result from direct contact to an antenna such as a dipole or monopole antenna (element type antenna). Unlike an electrical burn, which would be somewhat contiguous on the skin, a RF burn is concentrated in a very small area of the skin and penetrates deeply such as on a fingertip.

6.8. Radiofrequency Technical Information

1. General. The current army definition of RF applies over the range from 3 kHz to 300 GHz. The wavelengths associated with this limited electromagnetic spectrum extend from 100 kilometers at 3 kHz to 0.1 cm at 300 GHz. Frequencies below RF are referred to as Sub-radiofrequency. The various RF frequency band ranges are specified below.
2. Transmission. Emission of Radiofrequency Radiation. RF radiation requires a generator or source, a transmission line, and an antenna. Most systems require additional components relevant to the waveform and use of the device.

A. Generator. RF radiation sources, or generators, convert electrical power into RF radiation using appropriate technologies such as oscillators or magnetrons. The radiation requirements of the system determine the type of generator or RF radiation source used. An oscillator is the most basic type of radiation source and consists of a tuned resonant circuit. The basic RF radiation generator is often used as the input to other high power amplifiers. These amplifiers, such as the klystron and traveling wave tube, increase the power of an oscillator output. A magnetron is a vacuum tube with resonant cavities. These generators do not require an oscillating source or amplifiers.

B. Transmission Line. RF radiation, once produced and possibly modulated, is guided from the generator to the antenna through a waveguide, coaxial cable, or other type of wire. A waveguide is a long, hollow conductor usually rectangular, the dimensions of which can be designed to accommodate the transmission of any frequency. A waveguide is impractical at frequencies lower than a few hundred MHz and is usually used for frequencies of 3 GHz and higher. Coaxial cables will transmit frequencies up to 3 GHz. A collinear pair of wires will suffice for RF radiation up to 100 MHz.

C. Antenna. The antenna is used to make a transition from a guided wave (from the transmission line) to a radiated electromagnetic wave. The design of the antenna is influenced by many factors such as size, frequency, and electrical impedance. Antennas are normally of two types - omnidirectional and directional. The omnidirectional antennas are element type antennas such as monopoles or dipoles. The directional are horn-type antennas, parabolic dish type antennas such as a satellite communications antenna (SATCOM), or a phased-array antenna which can emit many beams at once. The characteristics of the antenna are a very important aspect of hazard evaluation.

3. Applications. Information gathering devices emit RF radiation. The devices include radar (air and ground), transponders, motion detectors, projectile tracking, surveillance, and many additional types of information gathering devices. Broadcast devices include radio and satellite communication terminals and electronic countermeasures systems.

Table 6-G: Radiofrequency Bands and Spectral Designations

Spectral Band Abbreviation	Spectral Band Designation	Range
ELF	Extremely Low Frequencies	0 - 3 kHz
VLF	Very Low Frequencies	3 - 30 kHz
LF	Low Frequencies	30 - 300 kHz
MF	Medium Frequencies	300 - 3000 kHz
HF	High Frequencies	3 - 30 MHz
VHF	Very High Frequencies	30 - 300 MHz
UHF	Ultra High Frequencies	300 - 3000 MHz
SHF	Super High Frequencies	3 - 30 GHz
EHF	Extremely High Frequencies	30 - 300 GHz

6.9. Medical Effects, Symptoms, and Treatments of Radiofrequency

1. References:
 - A. Textbook of Military Medicine, Part III, Volume 2, Chapter 15, 1993.
 - B. National Council on Radiation Protection and Measurements Report No. 86, *Biological Effects and Exposure Criteria for Radiofrequency Electromagnetic Fields*, 2 April 1986.
 - C. Institute of Electrical and Electronics Engineers (IEEE) C95.1-1991, April 27, 1992, *IEEE Standard for Safety Levels with Respect to Human Exposure to Radiofrequency Electromagnetic fields, 3 kHz to 300 GHz*.
 - D. DODI 6055.11,21 February 1995, *Protection of DOD Personnel from Exposure to radiofrequency Radiation and Military Exempt Lasers*.
 - E. OTSG Policy Letter, Vision and Ocular Assessments of Personnel in Laser and Radiofrequency Radiation Environments, 11 April 1994.
2. Introduction. The primary concern of exposure to RF radiation is thermal overload. When RF energy is absorbed by biological tissue, it is converted to heat. The recognized mechanisms of interaction produce thermal effects following adsorption of RF energy by ionic molecular, and/or cellular structures. If the amount of energy adsorbed exceeds the body's ability to dissipate heat, thermal stress (thermal overload) or injury can occur. The energy is dissipated in the body as

heat that increases body temperature. The body's thermoregulatory system response to dissipate this heat includes increased blood flow, vasodilation, and an increased sweat rate. The site of energy adsorption varies depending upon the orientation of the individual and the frequency of the electromagnetic energy. In the upper frequency bands, used by radar and satellite communication sets, the effect is limited to external organs such as the eyes and the skin. Internal organs may be affected at lower frequencies as the result of deep-body heating or induced currents. Other factors, which influence individual sensitivity to RF, are the individual's unique physiology (especially height, weight, and gender) and the external environment (such as temperature and humidity). Furthermore, energy deposition is not uniform throughout the body but is a function of the dielectric characteristics of various body tissues. RF excites thermal modes in water molecules, hence tissues with high water content such as skin and muscle are affected more severely than tissue with a low water content such as fat.

3. Medical Effects/Symptoms.

A. General. Current DOD and IEEE/ANSI national standards for human RF exposure are primarily based on the potential for exceeding the body's ability to thermoregulate. That threshold of thermoregulation is widely considered from medical research to be 4.0 Watts (W) kilogram (kg) of body weight, i.e., heat absorbed by the body (including RF energy absorption) or produced by the body that could cause a whole-body specific absorption rate (SAR) of greater than 4.0 W/kg could cause biological heating effects. A whole-body specific absorption rate (SAR) of 4.0 W/kg is a level one would typically experience from a brisk walk. The actual DoD and IEEE RF standards incorporate a ten-fold safety factor stating that personnel should not be exposed to SAR's of greater than 0.4 W/kg for whole-body exposure or 8.0 W/kg for partial-body exposures, respectively. Actual units of measurement for determining compliance with these standards are specified as permissible exposure limits (PELs), e.g., power density (mW/cm²), electric field (volts/m), and/or magnetic field (amps/m[A/m]).

B. Thermal Effects. During the operation of most RF sources, users may be exposed to levels of RF energy many times lower than permissible exposure limits. These levels, however, do not stress the thermoregulatory system. Consequently, no effects are observed nor can individuals perceive the RF energy being absorbed. With some higher power RF sources, especially at the SHF frequencies where the wavelengths are short, personnel can sometimes perceive the presence of RF energy. The perception of RF does not imply that an injury has occurred, especially when most of the energy is absorbed near the surface of the skin where temperature sensors abound. It is expected that many systems' operators will at some time in their careers perceive a mild warming sensation near a RF source. The perception of RF energy generally occurs at levels greater than but less than 5 times the PELs. At RF exposure levels between 5 times and 10 times the PELs, individuals not only perceive the RF energy but also will feel a discomfort in the presence of the field and will naturally shy away from the field. At RF exposure levels greater than 10 times the PEL, actual tissue damage may occur- usually in the form of erythema, i.e., reddening of the skin as if sunburned. The degree and amount of tissue damage can be worse, however, and depends on the RF exposure level obtained, the time duration of the exposure, and the frequency of the incident radiation.

C. RF Shock and Burn Effects. For RF frequencies lower than 100 MHz, shock and/or burn may result from physical contact with the radiating antenna and/or metallic conductors in close proximity to the antenna. These effects may result from either a spark discharge when one is close to a RF energized conductor. A RF burn results if enough contact current enters the body

through a small cross-section, such as the tip of a finger. Unlike a conventional burn or electrical burn, a RF burn can penetrate the skin several mm. A RF shock can also occur from a spark discharge. A RF shock will not necessarily produce a RF burn. However, individuals startled by a RF shock could injure themselves or someone else while jerking away from the source of a shock. The threshold for RF shock/burns is a function of the frequency, surface area of the contact point and individual sensitivity.

4. RF Exposure Treatment.

A. Thermal or RF contact current burns should be treated in a similar manner as conventional burns. Although similar, RF burns, whether thermal or contact current burns, are different from conventional burns in that contiguous tissue are not necessarily affected. Which tissues are affected depends on the frequency of the incident radiation and the dielectric properties and/or water content of the affected tissues. All other reported symptoms such as headaches, nausea, fatigue, anxiety, etc. should be treated in conventional manners, as appropriate.

B. Regardless of whether an injury has occurred, per the OTSG Policy Letter, April 1994, if it has been determined or suspected through evaluation of the incident that an individual has been exposed to RF radiation levels >5 times the PEL, it is also necessary to have a diagnostic ocular exam. This exam should be conducted within 24 hours, if possible, and can only be performed by an ophthalmologist, optometrist, or physician possessing the necessary skills/ qualifications. The diagnostic protocol basically consists of reviewing the ocular history of the exposed individual (with an emphasis on previous eye problems and the use of medication, especially those with photosensitizing side effects), a distance visual acuity check, and a Slitlamp Biomicroscope examination of the cornea, crystalline lens and other structures. The presence or absence of opacities in the ocular media will be recorded as a minimum.

C. USACHPPM should be contacted as soon as possible on any suspected overexposures to ensure a quick-response to the incident and a thorough investigation.

7 EQUIPMENT

Table of Contents

Equipment	7-1
General Information	7-3
7.1. References	7-3
7.2. NBC Signs	7-3
7.3. MICAD	7-3
Nuclear / Radiological Hazards	7-4
7.4. M28A1 RADIAC calculator set	7-4
7.5. Army Dosimeters (PDR-75, IM-9E/PD, IM-93, IM-147)	7-4
7.6. AN/PDR-77 and AN/VDR-2	7-6
7.7. AN/UDR-13 - Radiac Set	7-11
7.8. ADM-300 - MULTI-FUNCTION RADIAC	7-11
Biological	7-11
7.9. General	7-11
7.10. Biological Smart Tickets	7-11
7.11. Enzyme Linked Immunosorbent Assay (ELISA)	7-12
7.12. Polymerase Chain Reaction (PCR)	7-12
7.13. Bioassay	7-12
7.14. IBADS	7-13
7.15. M31EI Biological Integrated Detection System (BIDS)	7-13
Chemical Detectors	7-14
7.16. M8 - Chemical Agent Detection Paper	7-15
7.17. M9 - Chemical Agent Detection Paper	7-16
7.18. M18A2 - Chemical Agent Detector Kit	7-16
7.19. M256A1 – Chemical Agent Detector Kit	7-16
7.20. M272 - Water testing kit for chemical agents	7-16
7.21. Chemical Agent Monitor (CAM, ICAM, and ICAM-APD)	7-17
7.22. Individual Chemical Agent Detector (ICAD)	7-18
7.23. M90 D1A Chemical Agent Detector (CAD)	7-18
7.24. M8A1 Automatic Chemical Agent Alarm System	7-18

7.25.	MM-1 Mobile Mass Spectrometry Gas Chromatograph _____	7-19
7.26.	M-21 Remote Sensing Chemical Agent Automatic Alarm (RSCAAL) _____	7-19
7.27.	SAW Mini-CAD _____	7-19
7.28.	M22 Automatic Chemical Agent Alarm (ACADA) _____	7-20
7.29.	Miniature Automatic Continuous Air Monitoring System (Field Mini-CAMS) ____	7-20
7.30.	Viking Spectratrak Gas Chromatography / Mass Spectrometry _____	7-20
7.31.	HP 6890 Gas Chromatography with flame photometric detector _____	7-20
7.32.	Improved Chemical Agent Point Detection System (IPDS) _____	7-21
7.33.	Joint Chemical Agent Detector (JCAD) _____	7-21
7.34.	Joint CB Agent Water Monitor (JCBAWM) _____	7-21
7.35.	Joint Service Lightweight Standoff Chemical Agent Detector (JSLSCAD) _____	7-21
7.36.	Shipboard Automatic Liquid Agent Detector (SALAD) _____	7-21
7.37.	Special Operations Forces _____	7-21
7.38.	Automatic Continuous Air Monitoring System (ACAMS) _____	7-21
7.39.	AN/KAS-IA - Chemical Warfare Directional Detector _____	7-22
7.40.	Shipboard Chemical Agent Point Detection System (CAPDS) _____	7-22
7.41.	M-93 and M-93A1 FOX _____	7-22
	Medical Countermeasures for Chemical Exposures _____	7-23
7.42.	MES Chemical Agent Patient Treatment _____	7-23
7.43.	MES Chemical Agent Patient Decontamination _____	7-23
7.44.	Medical Chemical Defense Material (MCDM) _____	7-24
7.45.	Convulsive Antidote Nerve Agent (CANA) _____	7-24
7.46.	NAAK Mark 1 - Nerve Agent Antidote Kit _____	7-24
7.47.	Nerve Agent Pre-treatment Tablets (NAPP) _____	7-24
7.48.	TESTMATE _____	7-25
	Decontamination Equipment _____	7-25
7.49.	M258A1 - Skin decontamination kit _____	7-25
7.50.	M280 - Decontamination Kit, Individual Equipment _____	7-25
7.51.	M291 - Skin Decontamination Kit _____	7-26
7.52.	M295 - Decontamination Kit, Individual Equipment _____	7-26
7.53.	M11 - Portable Decontamination Apparatus _____	7-26
7.54.	M13 - Portable Decontaminating Apparatus _____	7-26
7.55.	M17 Lightweight Decontamination System _____	7-26
7.56.	Decontamination Solution No. 2 (DS2) _____	7-27

7.57.	M21 /M22 / MDS - Modular Decontamination System (MDS)	7-27
7.58.	Sorbent	7-28
Protection		7-28
7.59.	M17 Protective Mask	7-28
7.60.	M40 / M42 Chemical/Biological Protective Mask	7-28
7.61.	M45 - Aircrew Chemical Biological Protective Mask System	7-29
7.62.	M48/49 - Aircrew Chemical Biological Protective Mask Systems	7-29
7.63.	MCU2A/P Chemical-Biological Mask	7-29
7.64.	Chemical Overgarment-84 (OG-84)	7-30
7.65.	Saratoga Suit	7-30
7.66.	JSLIST	7-30
7.67.	Joint Firefighter Integrated Response Ensemble (J-FIRE)	7-30
7.68.	Decontaminable Litter	7-31
7.69.	PPW - Patient Protective Wrap	7-31
7.70.	M20A1 Simplified Collective Protection Equipment (SCPE)	7-31
7.71.	M28 Simplified Collective Protection Equipment (SCPE)	7-31
7.72.	Chemically Protected Deployable Medical System (CP DEPMEDS)	7-32
7.73.	Chemically and Biologically Protected Shelter (CBPS)	7-32
7.74.	Portable Collective Protection System (PCPS)	7-32

General Information

7.1. References

Chemical and Biological Terrorism: Research and Development to Improve Civilian Medical Response by the National Research Council provides background information on the type of technology used by the many of pieces of equipment listed below.

7.2. NBC Signs

Chemical warning signs have yellow backgrounds with red lettering. Biological warning signs have blue backgrounds with red lettering. Radiological warning signs have white backgrounds with black lettering. Chemical Minefield signs have red backgrounds with yellow lettering and a stripe. See Appendix C of FM 3-7 for Warsaw Pact Markers.

7.3. MICAD

The MICAD is a near real-time integrated NBC detection, warning, and reporting system to be employed in area warning, combat and armored vehicles, and tactical van and shelter mission profiles. The MICAD automates the current NBC warning and reporting process throughout the battlefield by automating the gathering of NBC contamination data from fielded NBC detectors and sensors. It then automatically formats and transmits alarms, NBC-1 and NBC-4 reports through the chain of command on the battlefield. Most new equipment has MICAD compatibility built in (plug and play).

Nuclear / Radiological Hazards

7.4. M28A1 RADIAC calculator set

The M28A1, NSN 6665-01-130-3616, determines the yield of the nuclear detonation from various measurements. Instructions for use of the M4A1 calculator are on the card in the set. Upon receipt of the M4A1 calculator, the user should solve the example problem on the instruction card. If the calculator will not solve the example problem to within the specified tolerance, destroy it and obtain a new one. Complete operating instructions are in TM 3-6665-303-10.

7.5. Army Dosimeters (PDR-75, IM-9E/PD, IM-93, IM-147)

1. References: Academy of Health Sciences Publication GR 76-332-200, FM 3-7, FM 8-9, TM 11-665-214-10, and TM 11-665-236-12.
2. For field operations, the Army uses two types of dosimeters. The IM-9E/PD, the IM-93, and the IM-147 are pocket dosimeters with ionization chambers. The PP-1578A/PD is required to charge these dosimeters. The AN/PDR-75 consists of the DT-236 wristwatch and the CP-696 Computer Reader. The DT236 uses the process of scintillation, or the conversion of radiation into detectable light, to record gamma; and the process of a solid state semi-conductor for neutron radiation. The solid-state semi-conductor must be heated to obtain a radiation dose reading. Therefore, those DT236s read directly after radiation exposure will not show the true amount of radiation received. For best accuracy, 24 hours should pass from the time of exposure to the time of the reading. The PDR-75 has a digital readout.
3. **IM-143/PD.** The IM-143/PD Series Dosimeter is a tactical, self reading, total dose pocket dosimeter used to determine the total accumulated dose of gamma radiation.
4. **IM-147/PD.** Single barrel low range "quartz fiber," self-indicating pocket dosimeter. Range: 0-50R (gamma). Charged by PP-1578 radiac meter charger.
5. **IM-9.** Reads from 0-200 mR gamma. It is a "Quartz-Fiber," self-indicating, pocket dosimeter.
6. **IM-93 (A)/UD & (B)/UD.** Mid range dosimeter (<1000R). Single barrel, "Quartz-Fiber," self-indicating pocket dosimeter. Range 0-600 R (gamma). Charged by PP-1578 radiac meter charger.
7. **PP-4276/PD.** The PP-4276/PD Series Radiac Detector Charger is used to charge the IM-143/PD Series Dosimeter. The unit consists of a charger receptacle, internal battery, high voltage generator with variable output control, and provisions for illuminating the scale of the dosimeter being charged.

8. **DT-236/PDR-75.** NSN # 6665-01-211-4217. The AN/PDR-75 provides the capability to monitor and record the exposure of individual personnel to gamma and neutron radiation through a wrist worn device. It is a tactical dosimeter with 1 to 1000 cGy indirect reading for neutron and gamma dose measurement by separate devices. It responds to and measures prompt radiation from nuclear bursts. The PRD-75 will be used to calculate unit radiation status, for medical triage, and for unit reconstitution. Elements are encased in a tamper resistant locket, which is worn on the wrist. Dosages are cumulative and are permanently recorded.

A. The DT236 uses the process of scintillation, or the conversion of radiation into detectable light, to record gamma; and the process of a solid state semi-conductor for neutron radiation. The solid-state semi-conductor must be heated to obtain a radiation dose reading. Therefore, those DT236s read directly after a nuclear burst will not show the true amount of radiation received. During this response time, readings should be obtained with the IM93 dosimeters and used for planning purposes once the 24 hours has elapsed.

B. The reader for the DT-236/PDR-75 is a single unit which accepts the dosimeter, opens it, activates the neutron detecting diode and the silver activated phosphate glass gamma detector, reads both and displays the results. The gamma detecting glass is read fluorimetrically using UV excitation. The neutron detecting diode is read by measuring its forward voltage drop at constant current conditions. This reading does not change the recorded dosage.

C. Description and Use. Each individual will be issued a DT236/PDR-75 dosimeter. This device, worn on the wrist, contains a neutron diode and a phosphate glass gamma detector. When a determination of exposure is required, the dosimeter is inserted into a CP-696/PDR-75 reader, which then displays the cumulative neutron and gamma dose.

Table 7-A: Army Dosimeters

Characteristic	AN/PDR-75	IM-9E/PD	IM-93	IM-147
Use	Personnel dosimeter	Clinical	Tactical	Tactical
Total dose range	0-999 cGy	0-0.2 cGy	0-600 cGy	0-50 cGy
Scale increments	1 cGy	10 mR	20 RAD	2 RAD
Maximum acceptable leakage	NA	4 mR/day	12 RAD/day	1 RAD/day
Temperature range	-25° to +125° F	-65° to +132° F	-40° to +150° F	-40° to +150° F
Type of radiation detected	Gamma rays and neutrons	X- and gamma rays	X- and gamma rays	X- and gamma rays
Type of detector	Radiophoto-luminescence glass for gamma rays and PIN diode for neutrons.	Ionization chamber	Ionization chamber	ionization chamber
Type of indicator	Digital	Image of electrometer fiber on calibrated scale	image of electrometer fiber on calibrated scale	image of electrometer fiber on calibrated scale
Other equipment needed	DT-236 wristwatch CP-696 Computer Reader	PP-1578A/PD	PP-1578A/PD	PP-1578A/PD
Tolerance	± 30% or ± 30 cGy, whichever is less, with 95% confidence after 24		± 10%	± 10%

hours.			
--------	--	--	--

Reference: References for this section.

Figure 7-A: Army Pocket Dosimeter

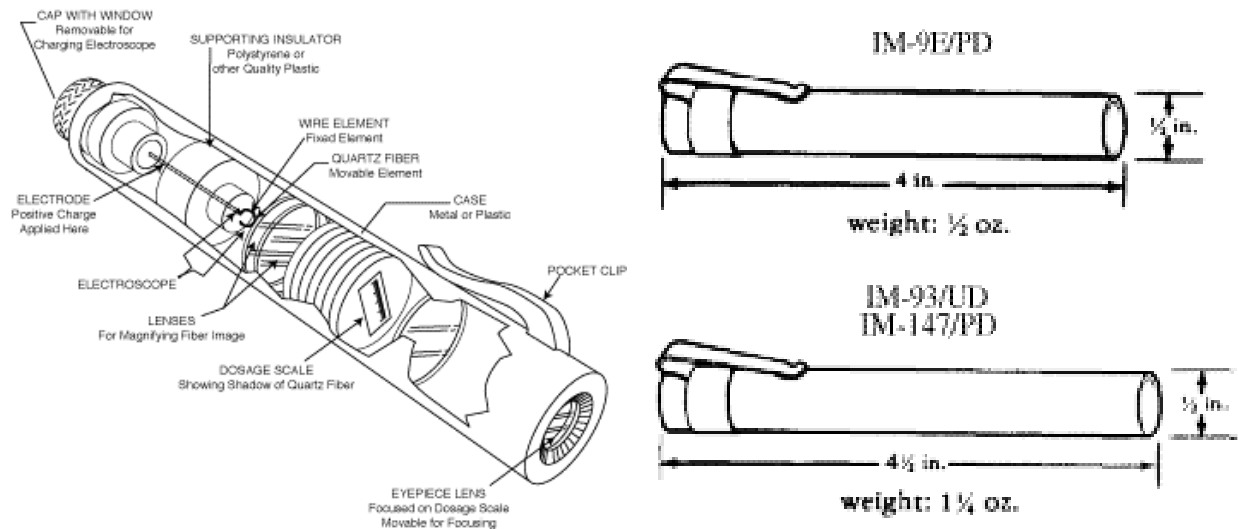

Reference: Figure A-I from FM 8-9 (Part I) (left) and, TM 11-665-214-10 (right).

Figure 7-B: AN/PDR-75

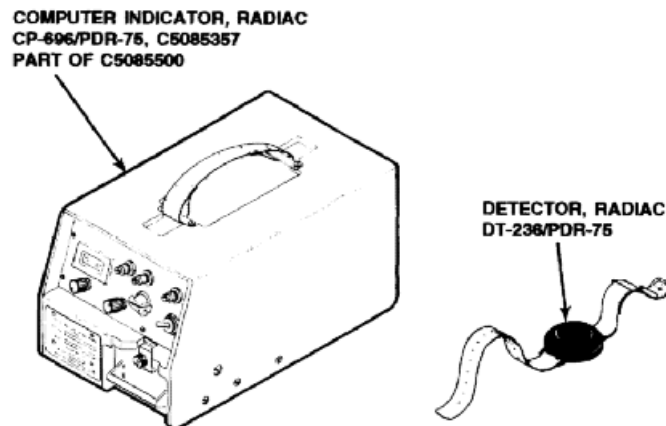

Reference: TM 11-665-236-12.

7.6. AN/PDR-77 and AN/VDR-2

- References: Addendum Test Report for the Production Qualification Test (PQT) of the ALPHA RADIAC Set, AN/PDR-77, ACALA's *Radioactive Material Handling Safety*, and TM 11-6665-365-12&P, The Technical Manual for the PDR-77. The purpose of this section is to provide additional information on the probe beyond that found in TM 11-6665-365-12&P, The Technical Manual for the PDR-77. Refer to that manual for operating information.

2. Alpha, Gamma, Low Energy X-ray RADIAC set (multi-function rate meter), NSN# 6665-01-347-6100, replaces AN/PDR-56F and AN/PDR-60 as primary radiac device to respond to nuclear accidents and conduct routine health and safety surveys. The basic kit consists of a display unit (the Radiacmeter) and three probes (Alpha, Beta/Gamma, and X-Ray). An extension kit has had limited distribution and includes a beta pancake and NaI Scintillation probes. The program manager of the PDR-77 is Mr. Groeber, PM, BNCDS, CDBCOM.
3. Radioactive Materials contained in the PDR-77. The PDR-77 contains 1 nCi of Thorium-232 that must be disposed of IAW AR 385-11 and TM 3-261.
4. Display Unit. The Radiacmeter Control Units have digital readout, automatically recognize the attached probes, and show rate information in the appropriate units. One can program alarm set points and background subtraction. The power supply is three 9-volt batteries, BA3090, or vehicular power systems.
5. Beta/Gamma Probe. The display unit with the beta/gamma probe is known separately as the AN/VDR-2. The AN/VDR-2 is used to perform ground radiological surveys in vehicles or in the dismounted mode by individual soldiers as a hand-held instrument. The set can also provide a quantitative measure of radiation to decontaminate personnel, equipment, and supplies. Components of the Radiac Set include the Radiacmeter IM-243, probe DT616, and pouch with strap. Installation kits are available as common table allowances (CTA) items for installation of the Radiac Set in various military vehicles. The set includes an audible and/or visual alarm that is compatible with vehicular nuclear, biological and chemical protective systems in armored vehicles. The beta/gamma is the proper probe to use in most situations. This probe measures the external dose rate from gamma radiation. Gamma radiation presents the greatest external hazard. If the beta window is opened, the probe will also measure beta radiation. However while operating in this mode, the probe should only be used to detect radiation and not for quantification. The beta/gamma probe contains two G-M tubes. According to the PQT for the PDR-77, the *most* beta/gamma will be accurate to $\pm 20\%$ at 0.0005 cGy/hr (0.5 mR/hr). This level is significantly higher than background radiation and dose rates normally associated with low level radiation. **Below 0.5 mR/hr, the beta/gamma probe should be used only for detection of radiation and not for quantification.**
6. Alpha Probe. The alpha probe is a 100-cm² Zinc Sulfide scintillation detector. It detects alpha particles and is usually read in CPM (counts per minute). According to the production tests, the probe is $\pm 10\%$ above 1000 CPM and $\pm 30\%$ from 200 to 1000 CPM. There is no data for below 200 CPM. The PDR-77 is capable of detecting alpha activity at 56.6 DPM per 100 cm². However, the PDR-77 is not accurate at this level. When measuring alpha radiation, the probe surface must be less than an inch from the source. If the probe detects alpha radiation, repeat the exact same reading with a single sheet of paper between the probe and the potential source. The paper will stop the alpha particles and the reading should return to near zero. If the reading is still high, then the mylar window on the probe is probably damaged. Change the window and repeat the readings.
7. X-ray Probe. The X-Ray probe is a 5 inch by 0.25 inch NaI crystal with a PMT that is useful in measurement X-ray below 95 keV. There are three energy ranges on the probe. The 17 keV selection detects photons with energy between 12.5 keV to 21.5 keV. The 60 keV selection detects photons with energies between 50 keV to 70 keV. The Peak Align selection detects

radiation from 70 keV to 95 keV. The probe was designed mainly to be used at nuclear weapons accidents (Broken Arrows). It is optimized to read the X-Rays associated with Plutonium-239 and Americium-241. The carrying handle is adjustable for height to allow the probe to be carried at the optimum height of 12 inches above the ground. The probe is capable of detecting 0.374 mg/m² of Plutonium-239 with the probe one inch from the source.

8. NaI Scintillation Probe. The NaI Scintillation Probe is part of the PDR-77 extension kit. It uses a 1 inch by 1.5 inch NaI crystal for detection. The probe is very energy dependent. There is no data available concerning the accuracy of this probe.
9. Beta Pancake Probe. The Beta Pancake Probe contains a pancake GM tube and is useful in detecting low energy beta radiation. There is no data available about the accuracy of this probe.
10. Scalar Mode. The PDR-77 can be run in the scalar mode to increase the sensitivity of the probe. The probe will average the readings over a 5-minute period to give a better indication of the radiation level.
11. Calibration. In order to give reliable readings, the PDR-77 must be calibrated every six months. The unit is calibrated as a single instrument. Therefore using a probe for one unit with the control unit from a different set may give erroneous readings.

Table 7-B: Relative Response of the AN/VDR-2

Detector Range	Effective Energy (keV)			
	70	120	170	663
VDR-2 Low Range Detector	0.7	1.12	1.06	1.0
VDR-2 High range Detector	0.7	0.95	1.0	1.0

Note: The VDR-2 has poor energy response below 80 keV and thus should not be used for low energy x-rays.

Reference: Table XXXI of TM 1-1500-335-23.

Figure 7-C: AN/PDR-77 with case on left. All the probes, including those from the extension kit, are on the right.

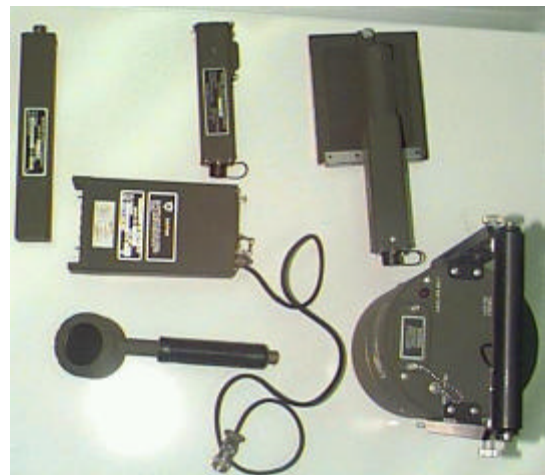

Figure 7-D: Beta/gamma probe (left) and AN/VDR-2 Beta/Gamma Probe (right)

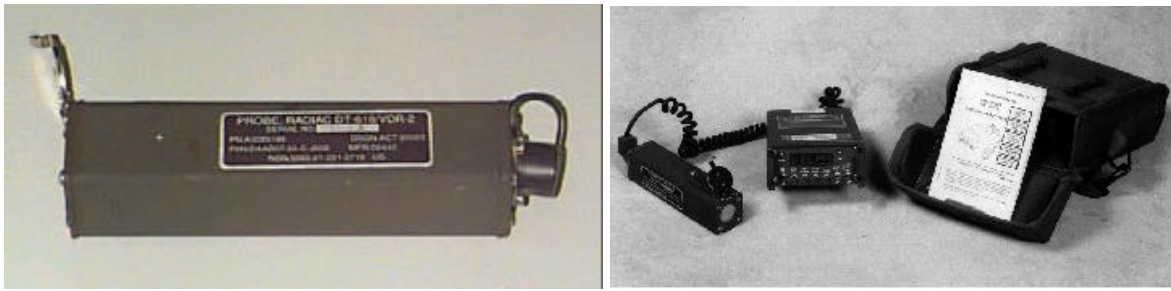

Figure 7-E: The proper use of the alpha probe is shown on the left and the improper use is on the right.



Figure 7-F: The X-Ray probe and the control unit is shown on the left. The proper use of the probe is shown on the right.



Table 7-C: PDR-77 Probe Selection Chart

Radionuclide / Source	β/γ Probe	Alpha Probe	X-ray Probe	Pancake Probe	μR Probe	Wipe Test
Tritium (^3H) / Fire Control Devices						
Detect Contamination						Y
Measure Contamination Level						Y
Locate Missing Source						
^{241}Am / M43A1 Chemical Alarms / Nuclear Weapons Accidents						
Detect Contamination		Y				Y
Measure Contamination Level						Y
Locate Missing Source	Y		Y			
^{241}Am / Beryllium Mix / Soil Density Detector (MC-1)						
Detect Contamination						Y
Measure Contamination Level						Y
Locate Missing Source						
^{63}Ni / CAM						
Detect Contamination	Y			Y		Y
Measure Contamination Level						Y
Locate Missing Source	Y			Y		
^{137}Cs / Soil Density Detector (MC-1) / Radiation Dispersal Devices						
Detect Contamination	Y				Y	Y
Measure Contamination Level						Y
Locate Missing Source	Y		Y		Y	
Radium						
Detect Contamination	Y					
Measure Contamination Level						
Locate Missing Source						
Thorium (Optical Glass)						
Detect Contamination	Y	Y				
Measure Contamination Level						
Locate Missing Source	Y		Y			
DU / Armor, Penetrators						
Detect Contamination	Y	Y		Y		Y
Measure Contamination Level						Y
Locate Missing Source	Y		Y	Y		
^{60}Co / Medical Devices / Radiation Dispersal Devices						
Detect Contamination	Y				Y	Y
Measure Contamination Level						Y
Locate Missing Source	Y				Y	

Reference: ACALA's *Radioactive Material Handling Safety*.

7.7. AN/UDR-13 - Radiac Set

The AN/UND-13 is a compact, handheld, or pocket carried, tactical device capable of measuring prompt gamma/neutron dose from a nuclear event plus gamma dose and dose-rate from a fallout environment in a tactical battlefield situation. A push-button pad enables mode selection, functional control, and the setting of audio and visual alarm thresholds for both dose-rate and mission dose. A "sleep" mode with automatic wakeup is provided to enhance battery life. Data readout and warning/mode messages are provided by liquid crystal display. Dosimeter capability of 1-999 cGy (neutrons/gamma-prompt initial and fallout). Ratemeter capability of 0.1-999 cGy/hr (gamma fallout).

7.8. ADM-300 - MULTI-FUNCTION RADIAC

The ADM-300 MFR replaces the PAC-IS, AN/PDR 27, AN/PDR 43, and AN/PDR 56 series radiation, detection and computation (RADIAC) instruments. The ADM-300 MFR is used to monitor and detect high and low intensities of radiation from radiological accidents and wartime levels of alpha, beta, and gamma radiation. The ADM300 MFR is available for worldwide mobility and is available at all U. S. Air Force installations.

Biological

Table 7-D: Sensitivities for Various Biological Detection Assays

Assay	Anthrax	Plague	VEE	Ricin
LD ₅₀	8 x 10 ³ spores	10 bacteria	10 PFU	20 ug
"Smart" Tickets	1 x 10 ⁵ CFU	1 x 10 ⁵ CFU	1 x 10 ⁶ PFU	2 ng
ELISA	Not tested	1 x 10 ⁵ CFU	1 x 10 ⁶ PFU	0.1 ng
PCR	30 CFU	30 CFU	100 PFU	Not tested
Bioassay	1 CFU	1 CFU	1 PFU	20 ug

NOTE: CFU stands for colony-forming units.

Reference: USAMRIID.

7.9. General

Chemical and Biological Terrorism: Research and Development to Improve Civilian Medical Response by the National Research Council provides background information on a variety of biological detection technologies.

7.10. Biological Smart Tickets

Smart tickets are hand-held point detectors based on antigen capture chromatography. The Navy Medical Research Institute at Bethesda, Maryland currently produces these instruments. Similar devices have recently become commercially available through Environmental Technologies Corporation. Eight different devices are used to assay liquid samples for the presence of *Y. pestis*, *F. tularensis*, *B. anthracis*, *V. cholerae*, SEB, ricin, botulinum toxins, and *Brucella* species, respectively. A color change provides a positive or negative indication within 15 minutes. The

sensitivity of these assays varies from an order of magnitude below a fatal dose (ricin) to more than an order of magnitude above the infectious dose (anthrax). These devices are strictly screening assays, and the analyses are subject to error from the introduction of other contaminants. Therefore, positive results need to be confirmed with standard microbiology assays, conventional immunoassays, or genome detection via polymerase chain reaction (PCR) technology.

7.11. Enzyme Linked Immunosorbent Assay (ELISA)

ELISA is a biological assay based on the specificity of the antigen-antibody reaction. These immunoassays are laboratory procedures used to detect specific antibodies that are developed by the body's immune system when the person is exposed to that biological agent. Antibodies can be found in serum or other body fluids from humans, animals, arthropods, or mosquitoes. The antibody in question is bound to the enzyme-linked antigen. The amount of enzyme-linked antigen coupled to the insoluble antibody is quantitated using a chromogenic substrate for the enzyme. The ELISA procedure can assay for either antibody or antigen. The 520th TAML and USAMRIID currently operate this system in the field.

7.12. Polymerase Chain Reaction (PCR)

PCR is an in vitro method for enzymatically synthesizing and amplifying defined sequences of DNA. The PCR process uses temperature to separate the two targeted DNA strands. Enzymes along with nucleotide bases (used as building blocks for copying) and probes are added with the target DNA. Nucleic acid probes are short nucleotide sequences generated in order to bind with specific regions of the targeted DNA. If the appropriate chemical and physical conditions are achieved the strands are repeatedly copied, separated, and recopied. This results in an exponential increase in the number of identical DNA pieces to yield enough material for analysis. Advantages of PCR are the sensitivity, specificity, speed (results can be obtained in hours rather than days or weeks), and the ability to detect difficult-to-grow, slow growing, and even non-culturable microorganisms. The thermal cycler and gel electrophoresis system provide capabilities to run PCR tests in the identification of biological warfare agents. The system is currently fielded to the 520th TAML.

7.13. Bioassay

Bioassay is the quantitative method in which the endpoint is an observable effect on a biological system or an organism. The classical approach to microbial detection involves the use of differential metabolic assays (monitored colorimetrically) to determine species type in the case of most bacteria, or the use of cell culture and electron microscopy to diagnose viruses and some bacteria that are intracellular parasites. Samples taken from the environment, such as soil and water, and most clinical samples must be cultured in order to obtain sufficient numbers of various cell types for reliable identification. The time required for microbial outgrowth is typically 4-48 hours (or two weeks for certain cases, such as *Mycobacterium tuberculosis*). Furthermore, bacterial culture suffers from an inherent drawback: cells that are viable may not be culturable, because they possess unanticipated nutritional requirements as a result of genetic mutation.

7.14. IBADS

The IBADS program will provide Naval forces a contingency capability, warning of the presence of biological and toxicological warfare agents. The IBADS is a point detector system designed for shipboard use. It is composed of a particle size counter, particle wet cyclone sampler, and a manual identifier (improved membrane calorimetric ticket flow-through assay). The antibody antigen tickets are used for BW agent identification in the ship's medical bay. The IBADS can detect and warn of the presence of 5 BW agents. The Navy has a total of 25 rapid prototypes that can be deployed with the fleet on short notice. The same technology is being used in the development of biological detectors for ports and airfields.

7.15. M31E1 Biological Integrated Detection System (BIDS)

M31E1 BIDS COMPONENTS: MI097 Heavy High-Mobility. Multipurpose Wheeled Vehicle. S-788 Lightweight multipurpose Shelter. PU-801 Generator. Bio Detection Suite. The BIDS consists of a shelter (S-788) mounted on a dedicated vehicle (MI097) and equipped with a biological detection suite employing complementary technologies to detect large-area biological attacks. The system includes a trailer mounted 15-kw generator (PU-801) to provide electrical power. The biological detection suite links aerodynamic particle sizing, bioluminescence, flow cytometry, mass spectrometry and immunoassay technologies in a complementary, layered manner to increase detection confidence. The BIDS will be a corps-level asset. Individual BIDS systems are strategically employed throughout the Corps area to create a sensor array/network. The BIDS network will be used for warning and confirming that a biological attack has occurred. It will provide presumptive identification of the biological agent being used, and will produce a safely configured sample for later laboratory analysis. The M31E1 BIDS is C130 aircraft-transportable, has roll-on/roll-off capability, and can operate in a dismantled role separate from its dedicated Heavy High Mobility Multipurpose Wheeled Vehicle.

Figure 7-G: BIDS



Chemical Detectors

Table 7-E: Sensitivity and Limitations of Chemical Monitoring Equipment

Equipment	Phase	Agent Symbol	Sensitivity	Time
M8 Paper	Liquids only	G VX H	100 μ drops 100 μ drops 100 μ drops	\leq 30 sec
M9 Paper	Liquids only	G XV H	100 μ drops 100 μ drops 100 μ drops	\leq 20 sec
M-18A2 Detector Kit	Liquid Vapor Aerosol	GB VX H, HN, HD, HT L, ED, MD CG AC	0.1 mg/ m ³ 0.1 mg/ m ³ 0.5 mg/ m ³ 10.0 mg/ m ³ 12.0 mg/ m ³ 8.0 mg/ m ³	2-3 min
M-256A1 Detector Kit	Liquid Vapor	G VX HD L CX AC,CK	0.005 mg/ m ³ 0.02 mg/ m ³ 2.0 mg/ m ³ 9.0 mg/ m ³ 3.0 mg/ m ³ 8.0 mg/ m ³	15 min Series is longer AC-25 min
M-272 Water Test Kit	Water	G VX HD L AC	0.02 mg/ m ³ 0.02 mg/ m ³ 2.0 mg/ m ³ 2.0 mg/ m ³ 20.0 mg/ m ³	7 min 7 min 7 min 7 min 6 min
Chemical Agent Monitor (CAM)	Vapor only	GA GB VX HD, HN	0.03 mg/ m ³ 0.03 mg/ m ³ 0.03 mg/ m ³ 0.1 mg/ m ³	30 sec 30 sec 30 sec \leq 1 min
Improved Chemical Agent Detector (ICAM)	Vapors	G V HD	0.03 mg/ m ³ 0.03 mg/ m ³ 0.1 mg/ m ³	10 sec 10 sec 10 sec
Improved Chemical Agent Detector- Advanced Point Detector (ICAM-APD)		G V H L	0.1 mg/ m ³ 0.04 mg/ m ³ 2.0 mg/ m ³ 2.0 mg/ m ³	30 sec 30 sec 10 sec 10 sec

Equipment	Phase	Agent Symbol	Sensitivity	Time
Miniature Chemical Agent Detector (ICAD)		G HD C AC, CK CG	0.2-0.5 mg/ m ³ 10.0 mg/ m ³ 10.0 mg/ m ³ 50.0 mg/ m ³ 25.0 mg/ m ³	2 min (30 sec for high levels) 2 min 15 sec
M-90 DIA Chemical Agent Detector	Vapor only	G V Mustard Lewisite	0.02 mg/ m ³ 0.02 mg/ m ³ 0.2 mg/ m ³ 0.8 mg/ m ³	10 sec 10 sec 10 sec 80 sec
M-8A1 Alarm Automatic Chemical Agent Alarm	Vapor only	GA GB GD VX HD	0.2 mg/ m ³ 0.2 mg/ m ³ 0.2 mg/ m ³ 0.4 mg/ m ³ 10.0 mg/ m ³	≤ 2 min ≤ 2 min ≤ 2 min ≤ 2 min ≤ 2 min
MM-1 Mobile Mass Spectrometry Gas Chromatograph	Vapor	20-30 CWA	< 10.0 mg/ m ² Of surface area	≤ 45 sec
RSCAAL M-21	Vapor	G H L	90.0 mg/ m ³ 2300 mg/ m ³ 500 mg/ m ³	
SAW Mini-CAD	Vapor	GB GD HD	1.0 mg/ m ³ 0.12 mg/ m ³ 0.6 mg/ m ³	1 min 1 min 1 min
ACADA (XM22)	Vapor	G HD L	0.1 mg/ m ³ 2.0 mg/ m ³ -----	30 sec 30 sec
Field Mini-CAM		G V H L	<0.0001 mg/ m ³ <0.0001 mg/ m ³ <0.003 mg/ m ³ <0.003 mg/ m ³	< 5 min < 5 min < 5 min < 5 min
Viking Spectratrak GC/MS		G V HD Many others	<0.0001 mg/ m ³ <0.0001 mg/ m ³ <0.003 mg/ m ³	< 10 min < 10 min < 10 min
HP 6890 GC with flame photometric detector		G V HD Many others	<0.0001 mg/ m ³ <0.0001 mg/ m ³ <0.0006 mg/ m ³	< 10 min < 10 min < 10 min

Reference: Table 4-1 from National Research Council's *Chemical and Biological Terrorism: Research and Development to Improve Civilian Medical Response*.

7.16. M8 - Chemical Agent Detection Paper

The M8 Chemical Agent Detection Paper is chemical treated, dye impregnated paper, issued in a book of 25 sheets. It is designed to detect liquid V, G, & H agents. M8 paper will change colors to identify non-persistent G-type nerve (yellow), V-type nerve (black or dark green), or blister (red) agents. The chemical reaction between the M8 Paper and a chemical agent produces a pH dependent color change in the paper that indicates the presence of chemical contamination. M8 Paper does not detect agent vapor and must contact the liquid chemical agent. M8 Paper is widely distributed on the battlefield, with each soldier carrying a booklet in his protective mask carrier. M8 Paper is also included in the M256A I Kit and in the M18A2 Chemical Agent Detection Kit. The M8 Paper is never used as the sole basis for agent identification. An alternate means of identification such as the M256A1 Kit should be used to confirm the nature of the chemical contamination. Undamaged paper has an indefinite shelf life. It has the potential for false positives.

7.17. M9 - Chemical Agent Detection Paper

The M9 Chemical Agent Detection Paper is chemical treated, dye impregnated, adhesive backed paper, issued in a 30-foot roll. The paper is cut off the roll in short strips when needed in the field. The agent sensitive dye will turn red upon contact with liquid nerve agents (G and V) and blister agents (H and L). It can be readily attached to the body or to vehicles, shelters, and other equipment. The M9 paper does not identify either the specific agent or the type of agent encountered. The paper produces colored spots when in contact with nerve and blister agents. The M9 is packed in a cardboard dispenser box equipped with a serrated feedout edge for cutting the paper to the required lengths. The dispenser is sealed in a moisture-vapor barrier bag together with a re-sealable plastic bag. Because of the difficulty in identifying a color change in the M9 Paper during night time operations under "red light" conditions, personnel must be periodically rotated into white light areas to check for color changes

7.18. M18A2 - Chemical Agent Detector Kit

The M18A2 is a hand-held chemical sampling test kit made up of detector tubes, tickets, paper, substrates, and instructions contained in a carrying case. The M18A2 is used to detect and classify dangerous concentrations of toxic chemical agents in the air and liquid chemical agent contamination on exposed surfaces. The kit is also used to collect and forward samples of unidentified toxic chemical agents to a technical intelligence team or laboratory for identification. It is in use by Tech Escort Units.

7.19. M256A1 – Chemical Agent Detector Kit

The M256A1 is a portable and disposable chemical agent detector kit. Each kit consists of a carrying case, 12 sampler-detectors, instructor cards, and M8 chemical agent detector paper. The sampler-detector is used to test for chemical agents in the air. It is usually used to determine when it is safe to unmask after a chemical agent attack. Battlefield contaminants can interfere with the M256 giving false readings. The M256 has a 5-year shelf life and is based on color-change chemistry.

7.20. M272 - Water testing kit for chemical agents

The M272 is a lightweight portable kit that will detect and identify harmful amounts of chemical warfare agents when present in raw and treated water. It is a test water sampler and is not a continuous monitor. The M272 has a 5-year shelf life. Each kit conducts 25 tests for each agent.

7.21. Chemical Agent Monitor (CAM, ICAM, and ICAM-APD)

1. The Chemical Agent Monitor (CAM) is a hand-held, battery operated device for the monitoring of decontamination procedures and effectiveness on personnel and equipment. It can detect and discriminate between vapors of nerve and blister agents and display the relative concentration, as well as detecting and discriminating between other agents. The CAM has a radioactive source. If the CAM becomes saturated with vapors, it can take up to 15 minutes before it can be used again. The battery lasts 6-8 hours in continuous use.
2. ICAM - Improved Chemical Agent Monitor. The ICAM is a hand-held, soldier-operated, post-attack device for monitoring chemical agent contamination on people and equipment. It detects vapors of chemical agents by sensing molecular ions of specific mobilities (time of flight) and uses timing and microprocessor techniques to reject interferences. The monitor measures 4 x 7 x 15-inches and weighs approximately 5 pounds. The ICAM starts up faster after prolonged storage and is more reliable than the CAM. The ICAM does not require a specific military occupational specialty to operate and is used by a wide variety of units.
3. ICAM-APD – Improved Chemical Monitor – Advanced Point Detector. The ICAM-APD weighs 12 pounds and has both audible and visual alarms.
4. Personnel using either the CAM or ICAM should be in full NBC protective postures.

Table 7-F: Common Interferents for the CAM

Interferent	G bar response	H bar response
M258A1 decontamination kit	-	High
M280 DKIE	-	High
DS 2	Low	-
Insect repellent	Low-Very High	-
Break fluid	High-Very High	Very High
Cleaner, general purpose	High	-
Burning kerosene	-	High
Breath mints	High	-
Gasoline vapor	Low	Low
Burning grass	Low-High	Low
Burning gas	Low	-
Green smoke	Low	Low-High
Break free oil	Low	-
Ammonia	Very High	-

Reference: Table 3-18 from FM 3-7, Table 3-44 from FM 3-7.

Figure 7-H: CAM Levels on right. Picture of CAM on left.

Number of bars	Hazard Level
One to three	Low vapor hazard
Four to six	High vapor hazard
Seven to eight	Very high vapor hazard



7.22. Individual Chemical Agent Detector (ICAD)

The ICAD is a miniature lightweight chemical warfare agent detector that can be worn by the individual. It detects and alarms to nerve, blood, choking, and blister agents and is intended for a variety of applications. The ICAD may be used as a point detector. It may be connected with a radio for remote operations and can be mounted on vehicles. It has an audio and/or visual alarm capability. The ICAD weighs 8 oz, does not require maintenance, requires only minimal training, and does not contain a radioactive source. The Marines are presently fielding the ICAD.

7.23. M90 D1A Chemical Agent Detector (CAD)

The M90 CAD is a man-portable instrument designed to determine and indicate the hazard from nerve or blister (mustard) agent vapors present in the air. Hazard levels are indicated in high, medium, and low concentrations. The M90 is programmable, with the capability to add new agents as they are developed. The M90 can be transported via backpack carrier, vehicle, or used in a fixed site configuration. Operable from batteries, vehicle, or a main power supply, it is versatile and can be remotely controlled from the remote alarm unit. Additionally, the M90 can be connected to a computer to pinpoint agent concentrations. It is operable over a multitude of operational platforms, including day or night conditions. It can be used to verify clean areas, perform area surveys, identify contamination, and verify the effectiveness of decontamination operations. The M90 is currently fielded within the Air Force. The M90 uses ion mobility spectroscopy and metal conductivity technology to monitor up to 30 chemicals in parallel.

7.24. M8A1 Automatic Chemical Agent Alarm System

The M8A1 is an automatic chemical agent detection and warning system designed to detect the presence of nerve agent vapors or inhalable aerosols. The system is an electrochemical, point sampling, chemical agent alarm that can be hand-carried, backpacked, or mounted on a tactical vehicle. The system detects vapors of chemical agents by ionization. The system is composed of an M43AI Chemical Agent Automatic Alarm Detector Unit and up to five M42 Chemical Alarm Units. The M8A1 Alarm System is used primarily to alert stationary units when a cloud of nerve agent vapor has arrived or is about to arrive at their position. The M8A1 will automatically signal the presence of the nerve agent in the air by providing troops with both an audible and visible warning. There are approximately 30,000 fielded units in service. The M8A1 requires a NRC license. Battlefield contaminants can interfere with the M256 giving false readings.

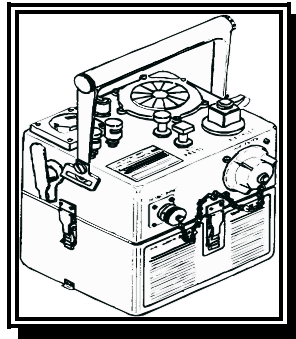
Figure 7-I: M43A1 Detector of the M8 Alarm

7.25. MM-1 Mobile Mass Spectrometry Gas Chromatograph

The MM-1 is the gas chromatograph used on the FOX Chemical Recon Vehicle. The system heats the contaminated surface to vaporize a small sample and then analyzes it. In addition to chemical agents, the MM-1 is capable of detecting a variety of industrial chemicals.

7.26. M-21 Remote Sensing Chemical Agent Automatic Alarm (RSCAAL)

Figure 7-J: M21 RSCAAL

The M-21 Remote Sensing Chemical Agent Automatic Alarm (RSCAAL) is a two-man portable tripod-mounted, automatic scanning, passive infrared sensor which detects nerve and blister agent vapor clouds based on changes in the infrared energy emitted from remote objects, or from a cloud formed by the agent. The M-21 is line-of-sight dependent with a detection range up to 3 miles and a field of view of 1.5 degrees vertical and 60 degrees horizontal. It will be used for surveillance and reconnaissance missions, and will search areas between enemy and friendly forces. Where possible, the RSCAAL will be employed in pairs (two reconnaissance teams) so that one RSCAAL can be used in the overwatch position when the other reconnaissance team is moving. The M21 is also mounted on the FOX vehicle. The audio alarm on the M-21 can be heard from 400 meters. LSCAD is the next generation M21 RSCAAL. It will permit detection on the move and from aerial platforms.

7.27. SAW Mini-CAD

The SAW Mini-CAD is a commercial available pocket-sized instrument that can automatically monitor for trace levels of toxic vapors of both sulfur mustard and the G nerve agents with a high degree of specificity. It does give false alarms from gasoline vapor and glass cleaner.

7.28. M22 Automatic Chemical Agent Alarm (ACADA)

The M22 system is an advanced, point-sampling, chemical agent alarm system employing ion-mobility spectrometry. It is man-portable, operates independently after system start-up, and provides an audible and visual alarm. The system detects and identifies nerve and blister agents. The M22 system also provides communications interface for automatic battlefield warning and reporting. The M22 can operate in area warning, survey, and monitoring roles. It can be powered by batteries or an AC power supply adapter. The M22 system replaces the M8A1 Alarm as an automatic point detector and augments the Chemical Agent Monitor as a survey instrument. The Army, Navy, Air Force, and Marine Corps will use the M22 primarily for area warning and to monitor collective protection shelters on vehicles. The M22 contains a radioactive source that requires a license. Battlefield contaminants can interfere with the M22 giving false readings.

Figure 7-K: M22 Alarm System



7.29. Miniature Automatic Continuous Air Monitoring System (Field Mini-CAMS)

Highly technical units such as the 520th TAML and Tech Escort use Field Mini-CAMS. They are designed for field industry monitoring and require 8 hours of training.

7.30. Viking Spectratrak Gas Chromatography / Mass Spectrometry

The Viking is commercially available lab quality equipment that is being used by some DOD units. It can analyze over 62,000 chemicals, in addition to chemical warfare agents.

7.31. HP 6890 Gas Chromatography with flame photometric detector

The HP 6890 is a state-of-the-art gas chromatograph used by the Chemical Weapons Convention treaty lab.

7.32. Improved Chemical Agent Point Detection System (IPDS)

The IPDS employs ion-mobility spectrometry and is an improved version of a point detection system. In addition to G nerve agents and VX, the IPDS is designed to detect vesicant agent vapors. It is to be a shipboard instrument, and therefore will be large and require power.

7.33. Joint Chemical Agent Detector (JCAD)

The JCAD will employ surface acoustic wave technology to detect nerve and blister agents. It is designed to be lightweight and portable and will reduce false alarms. The JCAD will also allow detection of new forms of nerve agents.

7.34. Joint CB Agent Water Monitor (JCBAWM)

The JCBAWM will be a portable device to detect, identify, and quantify CB agents in water. It will allow the user to sample water and receive a digital readout of the contents. The technology to be employed in the monitor is still under review.

7.35. Joint Service Lightweight Standoff Chemical Agent Detector (JSLSCAD)

The JSLSCAD is a passive, infrared detection unit employing Fourier Transform Infrared Spectrometry. The device is designed to detect nerve and blister vapor clouds at a distance of up to 5 km.

7.36. Shipboard Automatic Liquid Agent Detector (SALAD)

Technologies to be used in the SALAD have recently been reviewed, but no decision has been made on the final selection. The instrument is designed to be an automated, externally mounted liquid agent detector capable of detecting G nerve agent and VX and vesicant chemical agents.

7.37. Special Operations Forces

The Special Operations Forces Nonintrusive Detector and the Swept Frequency Acoustic Interferometry detector are portable, hand-held acoustic instruments developed specifically to enable rapid detection and identification of chemical warfare agents within munitions, railcars, ton containers, etc.

7.38. Automatic Continuous Air Monitoring System (ACAMS)

The ACAMS can detect G agents, VX, or mustard at very low levels. It is an automated gas chromatograph that first collects agent on a solid sorbent and then thermally desorbs the agent into a separation column for analysis. The components eluting from the column are detected by a flame-photometric detector, which can respond to compounds containing either phosphorus (i.e., GB and VX) or sulfur (mustard). A direct readout, in units of the hazard level, is given on the front panel of the instrument. A permanent trace of the chromatogram is provided on the strip-chart recorder. The ACAMS requires environmental protection from extreme heat, cold, and dust to function properly.

7.39. AN/KAS-IA - Chemical Warfare Directional Detector

The AN/KAS-IA provides standoff chemical agent detection capability for surface ships and has also been adapted to fixed-site shore facilities. It is a forward looking infrared (FLIR) based Electro-optic sensor that can remotely detect the presence of some chemical warfare agents. It also provides night vision capability for shipboard security. The standard shipboard installation consists of two AN/KAS-IA's (except for the smallest ships, which have one). Approximately 600 are deployed on surface ships.

7.40. Shipboard Chemical Agent Point Detection System (CAPDS)

The CAPDS is a fixed system capable of detecting nerve agents in vapor form using a baffle tube ionization spectrometer. CAPDS obtains a sample of external air, ionizes airborne vapor molecules, and collects them on a charged plate after eliminating lighter molecules via the baffle structure. When sufficient ion mass is collected, a pre-set potential is achieved, generating an alarm signal that is sent to damage control central and the bridge. The system is installed in an upper superstructure level and provides ships with the capability to detect nerve agents. The system will be activated when ships enter high threat areas and during operations in littoral waterways. The system is installed on most surface combatant's ships.

7.41. M-93 and M-93A1 FOX

The M-93 FOX NBC Reconnaissance System provides NBC detection, warning and sampling equipment integrated into a high speed, high mobility armored carrier with collection protection for its crew. The system contains a chemical agent monitor, a chemical agent detector alarm, a radiation detection device, a navigation system, secure communications, and an area marking system. The system provides combat information on the presence of NBC hazards, and can operate in all areas, in adverse weather and under all types of battlefield conditions. The road speed of the Fox is 55 mph and the water speed is 6 mph. Its armor is effective against small arms fire. The A1 modification reduces the crew to 3 and includes GPS, better electronics and communication, and the M21 RSCAAL.

Figure 7-L: M-93 FOX



Medical Countermeasures for Chemical Exposures

7.42. MES Chemical Agent Patient Treatment

UA (0249), LIN (M23673), 6545-01-141-9469. The Medical Equipment Set (MES) Chemical Agent Patient Treatment contains supplies and equipment required to provide unit, division, and corps level medical treatment to thirty contaminated casualties suffering from nerve, blood and blister agents. The basis of issue is two per battalion aid station/treatment squad, one per treatment team, and five per Combat Support Hospital. The weight is 247.99 lbs and cube is 20.420 cubic feet. There is no power requirement.

NSN	Number	Nomenclature
Medications		
6505-00-926-1440	5	Atropine 1% 1/8oz 12s
6505-00-926-9083	500	Atropine inj 0.7ml
6505-01-125-3248	100	Pralidoxim CHL inj 2ml
6505-01-206-6009	12	Sodium Nitrite inj 5s
6505-01-274-0951	45	Diazepam inj 2ml Unit
6505-01-332-1281	1	Atropine Sulf Inhal 6s
6505-01-334-8781	3	Sodium Thiosulfate 20s
Equipment		
6545-00-914-3490 E11794	3	Chest NO4 30x18x12 EM
6515-01-284-8704	2	Suction Appar Trach
6515-01-338-6602	4	Resuscitator Hand Oper

7.43. MES Chemical Agent Patient Decontamination

UA (0258), LIN (M25865), 6545-01-176-4612. The Medical Equipment Set (MES) Chemical Agent Patient Decontamination contains supplies and equipment required to decontaminate sixty contaminated casualties with nerve, blood, and/or blister agents. The basis of issue is one per battalion aid station/treatment squad, one per treatment team, and three per Combat Support Hospital. The weight is 1046.27 lbs and cube is 90.642 cubic feet. There is no power requirement.

NSN	Number	Nomenclature
8415-00-281-7813 A87412	2	Apron Tap Small
8415-00-281-7814 A87412	4	Apron Tap Medium
8415-00-281-7815 A87412	2	Apron Tap Large
6530-00-660-0034	8	Support Litter Folding
7240-00-773-0975	10	Pail Utility CRS 12qt
6545-00-914-3490 E11794	3	Chest NO 4 30xl 8xl 2 EM
6545-00-914-3510	1	Chest Med Inst Supp NO 6
6850-01-276-1950	2	Decontamination Kit
6530-01-380-7309	2	Litter Folding 91.60"
8610-00-255-471	40	Calcium Hypochlorite (bottle)

7.44. Medical Chemical Defense Material (MCDM)

See also CANA, NAAK Mark 1, and NAPP. The basic issue of MCDM to each soldier when deployed into an Area of Operations with a valid chemical threat includes three NAAK injector sets, one CANA, and 42 NAPP tablets (2 individual strip packages). The first NAAK injector set is to be used by the individual soldier upon suspicion of exposure to a nerve agent. The soldier's buddy uses the second and third NAAKs and the CANA once the soldier exhibits incapacitating symptoms of nerve agent exposure. All items of MCDM are perishable medical material. The Army established a centrally managed program in 1994 for the MCDM. This program provides funding for the Force Package 1 and 2 individual service member initial issue requirements. This materiel is centrally stored at designated storage locations as Division Ready Brigade (DRB) sets, forward deployed in high threat areas, and at DLA depots.

7.45. Convulsive Antidote Nerve Agent (CANA)

Convulsive Antidote Nerve Agent (CANA) is a convulsion antidote for nerve agents. CANA is an auto-injector that contains 2ml of diazepam (more commonly known as Valium) as the anti-convulsant. Diazepam is fully approved for this application by the USFDA. It is used only as buddy-aid, never self injected. CANA is a note 'Q' item requiring vault or safe storage. Additionally, this item must be stored at a controlled room temperature of 59-86 degrees Fahrenheit. The shelf life is two years.

7.46. NAAK Mark 1 - Nerve Agent Antidote Kit

The NAAK Mark 1 contains the AtroPen auto-injector (2mg of atropine) and the Pralidoxime Chloride auto-injector (600mg of pralidoxime chloride) in a compact package which facilitates emergency use. Atropine is in one of the injectors contained in the NAAK and is used as a treatment for nerve agent poisoning. The other injector contains 2-Pam Chloride. These drugs are fully approved for chemical agent treatment by the U.S. Food and Drug Administration (USFDA). NAAK must be stored in a controlled room temperature of 59-86 degrees Fahrenheit with limited access. The shelf life is five years. Side effects of inadvertent use of Atropine includes inhibition of sweating, dilation of pupils, dry mouth, decreased secretions, mild sedation, and increased heart rate. The side effects of the inadvertent use of 2-PAM-Cl include dizziness, blurred vision, nausea, and vomiting. These effects are insignificant in a nerve agent casualty.

7.47. Nerve Agent Pre-treatment Tablets (NAPP)

NAPP (also referred to as NAPS) contains Pyridostigmine Bromide tablets as a pretreatment for certain nerve agent poisoning (GA and GD). NAPP is designated as an Investigational New Drug by the USFDA for this application. Pre-treatment improves the efficiency of therapy for nerve agent poisoning. The drug is available as a 30mg tablet and should be taken orally, under orders, three times a day. The standard packing is a plastic and aluminum foil blister pack containing 21 tablets. Upon orders, NAPP is taken once every eight hours. Since NAPP is still considered an Investigational New Drug, the following release procedures apply: The Theater Commander-in-Chief (CINC) states the threat and need to use NAPP to the Joint Chief of Staff (JCS). The Assistant Secretary of Defense Health Affairs requests that the Food and Drug Administration

(FDA) allow DOD to use NAPP under IND protocol and also requests a waiver of informed consent. After this approval is received, the CINC can authorize release of NAPP to the individual soldiers in theater. NAPP must be stored under refrigeration between 35-46 degrees Fahrenheit. NAPP cannot be left out of refrigerated conditions for more than a cumulative period of six months. The shelf life NAPP is five years. The side effects include increased gastrointestinal activity, increased urination, headaches, runny nose, tingling, difficulty breathing, slurred speech, and increased blood pressure. These effects are insignificant in light of the vast enhancement of Mark I kit effectiveness against the nerve agent GD offered by NAPP.

7.48. TESTMATE

The Testmate is a hand-held instrument designed to rapidly assess the acetylcholinesterase level in blood samples. Fluctuations in the acetylcholinesterase level may indicate potential exposure to nerve agent. The Testmate can be utilized prior to deployments to determine baseline levels so potential exposures are better quantified. It is also used in the field as a rapid assessment tool for potential nerve agent exposure. Results from a sample can determine whether or not further investigations are needed. It recently received FDA approval. Two units have been fielded to the TAML.

Decontamination Equipment

Table 7-G: Standard Decontaminants

Decontaminants	Chemical	Biological	Nuclear
DS 2	X	X	
STB	X	X	
Mask sanitizing solution	X	X	
Soap and detergents	X	X	X
Weathering	X	X	X
Absorbents (earth, sawdust, ashes, rags)	X		
Sealants (concrete, asphalt, earth, paint)	X	X	X
Steam	X	X	X
Fire	X	X	

Reference: Table 3-49 from FM 3-7, Table 3-50 from FM 3-7.

7.49. M258A1 - Skin decontamination kit

The M258 is used to decontaminate skin contaminated by liquid chemical agents. It may also be used to decontaminate protective masks, hoods, gloves, helmets, and individual weapons. It is also useful in decontaminating sensitive equipment such as optics and electronics. Although soap and water are preferred, the skin decontamination kit may also be used to decontaminate biological agents. The M291 Skin Decon Kit will replace the M258 kit, although both kits will be in the field for a time.

7.50. M280 - Decontamination Kit, Individual Equipment

The M280 was designed to decontaminate an individual's chemical protective gloves, mask, hood, overboots, Load Bearing Equipment, and weapon.

7.51. M291 - Skin Decontamination Kit

The M291 is used for skin and equipment decontamination. It is non-toxic, eliminating the need for trainers. The M291 Skin Decontamination Kit consists of a wallet-like carrying pouch containing six individual tear-open decontamination packets; enough to do three complete skin decontaminations. Each packet contains an applicator pad filled with a nontoxic/non-irritating decontaminating powder. The M291 allows complete decontamination of skin through physical removal, absorption and neutralization of toxic agents. The M291 replaces the M258A1 Skin Decontamination Kit.

7.52. M295 - Decontamination Kit, Individual Equipment

The M295 Individual Equipment Decontamination Kit consists of a pouch with four individual packets containing decontamination wipe mitts. Each individual mitt consists of an absorbent resin contained within a non-woven polyester material and a polyethylene film backing. The M295 allows complete decontamination of all individual equipment; chemical-biological protective mask and hood, gloves, footwear, helmet, rifle, and load-bearing equipment. The M295 replaces the M280 and M258A1 when used to decontaminate equipment. The M295 employs the sorptive resin technology of the fielded M291 skin decontamination kit. Basis of issue is one container per squad/section, consisting of 20 individual kits.

7.53. M11 - Portable Decontamination Apparatus

DS2, 1 1/2 Quart (including ABC-M11). The M11 is used to decontaminate small areas that soldiers must touch. It is a steel container with an aluminum spray-head assembly and a nitrogen gas cylinder that provides the pressure. It is filled with 1-1/3 quarts of DS2, which is sufficient to cover 135 square feet. The ABC-M11 is an equipment-mounted, standard U.S. Army decontaminating apparatus used for operator spray-down decontamination. The item is man-portable (weight of approximately 5 pounds). The ABC-M11 has been replaced by the M13.

7.54. M13 - Portable Decontaminating Apparatus

The M13 is used to decontaminate vehicles and crew served weapons larger than a .50 caliber machine gun. The M13 consists of a pre-filled decontaminant (DS2) container, a hose, a manual pump, two wand sections, an attachable brush, and an accessory container. The M13 was developed as a replacement for the ABC-M11 portable decontaminating apparatus. The M13 is a man-portable, equipment mounted decontamination device used for decontaminating areas of vehicles or equipment requiring maintenance or personnel access. The item possesses a scrubbing capability and adequate decontaminant for coverage of 1,200 square-feet of surface area. The device may also be used as a replacement for five-gallon pails, mops, and brooms at equipment decontamination stations. The M13 is about the size of a 5-gallon gasoline can and comes pre-filled with 14 liters of DS2.

7.55. M17 Lightweight Decontamination System

The Lightweight Decontamination System is a compact, lightweight, portable decontamination system. It consists of a 7.3 horsepower engine, a self-priming pump for drawing and pressurizing water. It has a fan assembly to deliver combustion air to the heater, a water heater with a coil of tubing 90 feet (27.45 meters) long, a self-priming pump for the heater fuel system, and a small generator to supply electricity for ignition and safety control functions. The LDS is transportable by 3/4-ton trailers, 5/4-ton cargo trucks, cargo aircrafts, and helicopters (sling load). The LDS provides pressurized water at temperatures up to 248 degrees Fahrenheit (119.88 degrees Centigrade) at a rate of up to 9 gallons (34.06 liters) per minute. It draws water from a natural source up to 30 feet (9.15 meters) away and 9 feet (2.75 meters) below pump level. There is an additional 3000-gallon (113.55-hectoliter) water storage tank in the event that a natural source of water is not available. The system is salt-water resistant. The M17 is used for hasty, or deliberate, equipment decontamination, and can be used for personnel showers. The M17 provides first-time hasty decontamination capability for battalions. It replaces the M12A1 Decontamination Apparatus in chemical companies, thus improving logistics and mobility. The M17 also replaces the A/E32U-8 predecessor system.

7.56. Decontamination Solution No. 2 (DS2)

DS2 is a clear, amber colored liquid effective against all known toxic chemical agents and biological materials (except bacterial spores). It is issued in a 1 1/3 quart can (M11), 14-Liter container (M13), and 5 gallon container. DS-2 is extremely corrosive and dissolves paint. Since DS-2 is extremely corrosive it is not for use on people or on electronics or other sensitive equipment. DS-2 ignites spontaneously on contact with super tropical bleach (STB) or calcium hypochlorite (HTH).

7.57. M21 /M22 / MDS - Modular Decontamination System (MDS)

This system consists of the M21 Decontaminant pumper and M22 High Pressure/HOT Water Module. The M21 Decontaminant Pumper dispenses decontaminating solution-2 (DS2) or liquid field expedient decontaminants through spray wands. While mounted on a trailer, the M21 draws the decontaminant from a container on the ground. The M22 High Pressure Washer delivers hot-pressurized water up to 3000 psi at a rate of 5 gpm through two spray wands. Its accessories include the necessary hoses, wands, nozzles, hydrant adapters, and injector. The M22 High Pressure/Hot Water module can draw water from natural sources and dispense it at variable adjustable pressures, temperatures, and flow rates. The hydrant adapters provide a capability for using urban water supplies. The MDS (one M21 and two M22s) modules will be supported by associated support items of equipment (ASIOE), including two 3,000 gallon, self-supporting collapsible water tanks, and a 125-gpm-water pump. The MDS will equip the decontamination line at a detailed equipment decontamination site at the three stations described in FM 3-5. Each module (M21 or M22) may be transported or operated from a 3/4-ton trailer towed by a M1037 High Mobility Multipurpose Wheeled Vehicle. The MDS will be fielded to the dual-purpose smoke/chemical companies to conduct detailed equipment decontamination, replacing the M12A1 Skid Mounted Decon Apparatus. For operational decontamination, it replaces the M17 Lightweight Decontamination System. Chemical companies will use the MDS to fulfill the decontamination requirements of the initial wash, decontaminant application, and rinse steps of

detailed equipment decontamination. Non-chemical units may be provided components of the MDS for operational decontamination operations.

7.58. Sorbent

Sorbent Decon includes a family of chemical/biological decontaminants that increase decontamination efficiency. It will be less caustic than DS-2 with no water requirements. Development goals include improved time/labor requirements by neutralizing with less contact time and no scrubbing. There will be less environmental/ health risks and improved storage stability with a minimum service life of 10 years.

Protection

Figure 7-M: M40 Mask and Chemical Overgarment



7.59. M17 Protective Mask

The M17 chemical and biological protective mask assembly includes the mask, the M15A1 carrier, two lens outserts, and the M1 waterproofing bag. It is made of molded rubber with filter elements in each cheek, plastic eye lenses, and a voice emitter outlet valve in the front. The A1 and A2 models include the capability to drink water while masked. The mask protects the wearer's face, eyes, and respiratory tract against field concentrations of CB agents. The M40 Protective Mask is replacing the M17 Mask. See FM 3-5 for filter exchange rates.

7.60. M40 / M42 Chemical/Biological Protective Mask

The M40 Series protective mask (including the M42 Combat Vehicle Mask) is the standard protective mask. The mask consists of a silicone facepiece with in-turned periphery, binocular eye

lens system, and elastic head harness. Other features include front and side voice emitters, allowing for better communications, drink tube, clear and tinted inserts and filter canister with NATO standard threads. The mask protects against CB agents, toxins, radioactive fallout particles and battlefield contaminants. The M40/42 series field protective masks will replace the M17 (general purpose), M25 (vehicle crewman), and M9 (heavy-duty) masks. A face-mounted canister (gas and aerosol filter) can be worn on either the left or the right cheek, and can withstand a maximum of 15 nerve, choking, and blister agent attacks. It will also withstand a maximum of 2 blood agent attacks. Biological agents do not degrade the filter. The mask is furnished in small, medium, and large sizes. It provides the user with unobstructed and undistorted forward vision, and corrective lenses can be obtained. The mask also permits speech, does not interfere with hearing, and provides for a drinking capability while being worn. The mask can be worn continuously for 8 to 12 hours. See FM 3-5 for filter exchange rates.

7.61. M45 - Aircrew Chemical Biological Protective Mask System

The M45 will replace the Army's M49 Mask System. The mask provides the required CB protection without the aid of forced ventilation air while maintaining compatibility with rotary-wing aircraft sighting systems and night vision devices. See FM 3-5 for filter exchange rates.

7.62. M48/49 - Aircrew Chemical Biological Protective Mask Systems

The M48/49 has a pilot-mounted, motor blower, does not require an aircraft-mounting bracket, and can operate continuously for 8 hours on a single battery. The M49 will replace the M24 protective mask, as the general aviator's mask. The M48 will replace the M43 mask and will be worn only by Apache Helicopter Aviators. See FM 3-5 for filter exchange rates.

7.63. MCU2A/P Chemical-Biological Mask

The MCU2A/P Chemical-Biological Mask, with a serviceable canister installed, protects the face, eyes, and respiratory tract from chemical and biological warfare agents and radioactive dust. The MCU-2A/P is the standard ground crew mask used by all Air Force personnel. The MCU-2A/P has been fielded since early 1988.

Table 7-H: Protection Time for Chemical Overgarments

Item	Not exposed to chemical agents	Exposed to chemical agents
Battledress overgarment	*30 days	24 hours
Chemical protective overgarment	*14 days	6 hours
14/25-mil glove set	**	24 hours
Green/black vinyl overboot	**	24 hours
Chemical Protective footwear cover	**	24 hours
7-mil glove set	**	6 hours
*Times begin when removed from its sealed vapor bag, and stops when sealed back.		
**Will protect against liquid and vapor hazards as long as they remain serviceable.		

Reference: Table 3-2 from FM 3-7.

7.64. Chemical Overgarment-84 (OG-84)

The OG-84 is a camouflage colored (woodland or desert), expendable two-piece overgarment consisting of one coat and one pair of trousers. The OG-84 provides protection against chemical agent vapors, liquid droplets; biological agents; toxins and radioactive alpha contamination. When removed from its vapor-barrier bag and worn, its protective qualities last for a minimum of 30 days. The OG-84 provides a minimum of 24 hours of protection against exposure to liquid or vapor chemical agent.

7.65. Saratoga Suit

The Saratoga suit provides protection against chemical agent vapors, liquid droplets, biological agents, toxins, and radioactive particles. The Saratoga suit was the replacement for the OG-84 when initial fielding began in FY91. The Saratoga is a reusable, two-piece, camouflage (woodland and desert) suit consisting of a coat with integrated hood and trousers. The suit is made of a cotton ripstop outer layer and filter layer which consist of carbon spheres that absorb the chemical agents before they can reach the inner layer of the suit. In a non-NBC contaminated environment, the Saratoga may be laundered up to four times during its service life. Protective capabilities extend to 30 days with active protection of 24-hours during that period. It is not intended to be decontaminated or reimpregnated, and should be discarded within 24 hours after exposure to chemical agents. It protects against chemical agent vapors, aerosols, and droplets, and all known biological agents.

Table 7-I: Saratoga Chemical Protective Overgarment

Protection Period	24 hours
Durability	30 days continuous wear
Concentration Resistance	10 mg/m ² challenge for chemical agents and any challenge (battlefield) for biological agents
Max Effective temperature	120° F
Storage Life	13 years
Weight	Approximately 4.7 pounds (2.13 kilograms).

7.66. JSLIST

The JSLIST is a joint service program to design and develop the next generation of chemical/biological protective clothing ensembles. The JSLIST Overgarment design has raglan sleeves for more maneuverability, an integrated hood which eliminates the need for the heavy butyl rubber hood, is lighter, more supportable and has the ability to be laundered (up to six launderings). In addition, the system is more durable than the Battle Dress Overgarment and reduces heat stress associated with protective gear. The ensemble provides durability for 45 days of wear as opposed to the Battle Dress Overgarment's 30 days of durability.

7.67. Joint Firefighter Integrated Response Ensemble (J-FIRE)

J-FIRE consists of a chemical/biological protective mask and the JSLIST ensemble program. J-FIRE reduces the thermal burden placed on the firefighter when operating in proximity clothing.

while providing 24 hours of continuous liquid/vapor protection after 6 launderings. J-FIRE will be used by Air Force and Army fire fighters in fire fighting, life saving, and rescue operations in a toxic chemical/biological environment. The mask combines positive pressure air, self-contained breathing capabilities, and non-pressure breathing chemical/biological protection.

7.68. Decontaminable Litter

The decontaminable litter was developed to replace the canvas litters currently in use. This new litter is made of a monofilament polypropylene that has high tensile strength and low elasticity. The fabric does not absorb liquid chemical agents and is not degraded by decontaminating solutions. The carrying handles retract into the metal pole frame for a closed total length of 83.5 in (212.1 cm) to allow for loading the litter onto the UH-60 helicopter. The handle lengths are adjustable to conform to NATO standards as well as to allow for litter bearers' comfort. The aluminum poles are designed to provide direct gripping surfaces for litter stanchions as well.

7.69. PPW - Patient Protective Wrap

The wrap protects patients from all known chemical agents for up to six continuous hours. It is a single-use item, intended for discard after use. The wrap is a sturdy lightweight 2.7kg item. Although the protective wrap is permeable to both oxygen and carbon dioxide, the rate at which carbon dioxide is produced by a typical patient exceeds the rate at which gas passes through the wrap. The patient should not be left in the wrap for longer than six hours.

7.70. M20A1 Simplified Collective Protection Equipment (SCPE)

The M20A1 is a lightweight modular system that provides nuclear, biological and chemical (NBC) collective protection for existing structures. The M20A1 is a low-cost, lightweight, inflatable field shelter. It consists of a large liner assembly (10 feet high by 16 feet in diameter) that is inflated inside a room or building. A support kit, similar to a suitcase, contains the blower for inflation and flexible air ducts to direct the air. A collapsible protective entrance attaches to the inflated liner and serves as an air lock for personnel entry/exit. A hermetically sealed filter canister (HSFC) is provided to filter ambient air before it is introduced into liner area. A single system weighs approximately 500 pounds and occupies a 40 cubic foot area. The M20A1 is a clean-air shelter that allows personnel to perform duties without wearing individual protective equipment. The M20A1 can be used as a command/control or rest/relief shelter. The M20A1 can be deployed by two people and is easily maintained.

7.71. M28 Simplified Collective Protection Equipment (SCPE)

The M28 is a highly transportable collective protection system capable of providing chemical / biological protection for the tent, extendable, modular, personnel (TEMPER) enclosure. The modular system consists of entry/exit airlocks, liquid/vapor agent-resistant liner sections, blowers, recirculation filters for the interior of liners, and nuclear, biological, and chemical (NBC) filter(s). A tunnel airlock is available for litter patient entry/exit. Like the TEMPER, being modular, the M28 hardware allows for a variety of sizes and layouts, depending on the needs of a user. It permits configuring the hardware into a CB hardened enclosure as small as 16 feet to a layout as large as a Hospital Unit Base (HUB), which utilizes all M28 components needed to harden a fully

protected deployable medical system. The M28 provides CB hardening of TEMPER tent shelters for the medical or command post mission area. The M28 provides a clean-air shelter for use against CB warfare agents. The M28 is an inflatable shelter that allows personnel to perform duties without wearing individual protective equipment. The M28 liners take the shape of the tent when pressurized.

7.72. Chemically Protected Deployable Medical System (CP DEPMEDS)

The CP DEPMEDS provides large scale, environmentally controlled, collective protection for medical operations. CP DEPMEDS is a Tent, Extendable, Modular, Personnel (TEMPER), international Standardization Organization Rigid Wall Shelters and the M28 Simplified Collective Protection Equipment (SCPE) system to provide collective protection to the Hospital Unit Base of fielded DEPMEDS hospitals. The M28 SCPE includes chemically resistant TEMPER tent liners, litter, and ambulatory patient airlocks, and 200 cubic feet per minute filter blower units. Chemically hardened Field Deployable Environmental Control Units provide filtered, environmentally controlled air to the filter blower units in order to achieve an over-pressurized chemically protected facility. The CP DEPMEDS provides collective protection to casualties and hospital patients unable to don Individual Protective Equipment in response to an active chemical threat. It also allows surgical, clinical, and treatment personnel to continue performing critical medical procedures unencumbered by individual protective masks and gloves. The CP DEPMEDS provides collective protection for up to 72 hours in a chemically contaminated environment.

7.73. Chemically and Biologically Protected Shelter (CBPS)

The CBPS is a tactically mobile, quickly erectable, environmentally-controlled, collective protection shelter system. The CBPS is an integrated, self-contained system consisting of three major sub-components: a Lightweight Multipurpose Shelter (LMS) mounted on a High Mobility Multipurpose Wheeled Vehicle (HMMWV), an attached 300 square foot, air beam supported, chemically resistant soft shelter, and a High Mobility Trailer (HMT) with a 10 kW Tactical Quiet Generator (TQG) for auxiliary power. The CBPS provides a contamination-free, environmentally controlled, over-pressurized work area with litter and ambulatory patient airlocks to support casualty treatment in forward contaminated threat areas. A crew of four soldiers can deploy the system in less than twenty minutes. A single CPBS can function as a Battalion Aid Station, or the shelters can be connected to support the Division Clearing Station and Forward Surgical Team missions.

7.74. Portable Collective Protection System (PCPS)

The PCPS consists of the protective shelter, support kit, and hermetically sealed filter canister. The shelter consists of a tent and fly. The tent floor and fly are made of a saranaex composite material. An attached aluminum structure helps to support the tent. When overpressure is applied, the shelter will provide protection from liquid and vapor chemical agent penetration and biological agent penetration. An airlock allows decontamination of entering personnel. The PCPS provides an uncontaminated, positive pressure shelter for use as a command and control facility or a rest and relief facility for 14 people at a time in a contaminated environment.

8 POINT OF CONTACTS

Table of Contents

	Organization	Specialty	Branch	Page
8.1	Soldier and Biological Chemical Command (SBCCOM)	NBC	Army	8-3
8.2	Armed Forces Medical Intelligence Center (AFMIC)	NBC	DOD	8-3
8.3	Center for Health Promotion and Preventive Medicine (USACHPPM)	NC, Lasers, RF	Army	8-4
8.4	U.S. Army Chemical School	NBC	Army	8-4
8.5	US Army Nuclear and Chemical Agency (USANCA)	NC	Army	8-5
8.6	Defense Threat Reduction Agency (DTRA)	NBC	DOD	8-5
8.7	Army Medical Department (AMEDD) Center and School	NBC	Army	8-5
8.8	Medical Command (MEDCOM)	NBC	Army	8-5
8.9	HQDA, Office of the Surgeon General	NBC	Army	8-5
8.10	Army Material Command (AMC)	NBC	Army	8-5
8.11	Army Medical Materiel Development Activity (USAMMDA)	BC	Army	8-6
8.12	Walter Reed Army Medical Center (WRAMC)	NBC	Army	8-6
8.13	520th Theater Army Medical Laboratory (TAML)	NBC	Army	8-6
8.14	National Military Command Center (NMCC)	NBC	DOD	8-6
8.15	Crisis Coordination Center	NBC	DOD	8-6
8.16	U.S. Navy Command Center	NBC	Navy	8-6
8.17	U.S. Marine Corps Operations Center	NBC	Marine	8-6
8.18	U.S. Air Force Operations Center (AFOC)	NBC	Air Force	8-7
8.19	U.S. Army Operations Center (AOC)	NBC	Army	8-7

8.20	Director of Military Support	NBC	DOD	8-7
8.21	Chemical/Biological Incident Response Force (CBIRF)	BC	Marine	8-7
8.22	Tech Escort	NBC	Army	8-7
8.23	HAMMER Adaptive Communication Element (ACE)	Communications	Air Force	8-7
8.24	Assistant Secretary of Defense (Public Affairs)	NBC	DOD	8-8
8.25	Joint Nuclear Accident Coordinating Center (JNACC).	N	DOD	8-8
8.26	Armed Forces Radiobiology Research Institute (AFRRI)	N	DOD	8-8
8.27	Army Radiological Control Team (RADCON)	N	Army	8-8
8.28	Department of the Army Radiation Safety Office	N	Army	8-9
8.29	Industrial Operations Command (IOC)	N	Army	8-9
8.30	United States Army Ionizing Radiation Dosimetry Center (USAIRDC)	N	Army	8-9
8.31	US Army Armament and Chemical Acquisition and Logistics Activity (ACALA)	NC	Army	8-9
8.32	Radiological Advisory Medical Team (RAMT)	N	Army	8-9
8.33	Medical Research Institute of Chemical Defense (USAMRICD)	BC	Army	8-9
8.34	Armed Forces Institute of Pathology (AFIP)	NBC	DOD	8-10
8.35	Medical Research Institute of Infectious Diseases (USAMRIID)	BC	Army	8-10
8.36	Walter Reed Army Institute of Research (WRAIR)	NBC, Lasers, RF	Army	8-10
8.37	Centers for Disease Control and Prevention (CDC)	B	DHHS	8-10
8.38	Nuclear Regulatory Commission (NRC)	N	DOE	8-11
8.39	Radiation Emergency Assistance Center/Training Sites (REAC/TS)	N	DOE	8-11
8.40	Government Accounting Office (GAO)	NBC	GAO	8-11
8.41	Federal Emergency Management Agency (FEMA)	NBC	DOE	8-11
8.42	National Emergency Coordinating Center (NECC)	NBC	DOE	8-11

8.43	Emergency Information and Coordination Center (EICC)	NBC	DOE	8-11
8.44	Department of State – Operations Center	NBC	DOS	8-11
8.45	HQ DoE Emergency Operation Center	NBC	DOE	8-11
8.46	Public Affairs Guidance	NBC	DOE	8-12
8.47	Domestic Preparedness Web Page	NBC	DOD	8-12

8.1. Soldier and Biological Chemical Command (SBCCOM)

1. Reference: <http://www.cbdcom.apgea.army.mil/index.html>.
2. SBCCOM develops, acquires, and sustain NBC protective and detection equipment. It also provides for the safe storage and destruction of chemical materiel. SBCCOM is the primary focal point within the Department of Defense for NBC matters.
3. SBCCOM Public Affairs Office • Phone (410) 436-4345 • Facsimile (410) 436-5297. The Domestic Preparedness CB Helpline (nonemergency technical assistance) 1-800-368-6498; Fax 1-410-612-0715.
4. CBIAC. SBCCOM runs the Chemical and Biological Defense Information Analysis Center (CBIAC). The CBIAC generates, acquires, processes, analyzes, and disseminates CB Science and Technology Information in support of the CINCs, warfighters, the Reserve Components, the CB Defense Research, Development, and Acquisition community, and other federal, state, and local government agencies. They have a number of handbooks and guides on NBC equipment. <http://www.cbiac.apgea.army.mil>.
5. Edgewood Chemical/Biological Center. The Edgewood Center is the Army's principal R&D center for chemical and biological defense technology, engineering, and service. With a long and distinguished history of providing our Armed Forces with quality systems and outstanding customer service, we have achieved major technological advances for national defense, civilian needs, and industrial competitiveness. <http://www.apgea.army.mil/RDA/erdec/index.html>. Phone number: Commercial: 410-671-2879 or fax: 410-612-6529, DSN: 584-2879.

8.2. Armed Forces Medical Intelligence Center (AFMIC)

1. Reference: AFMIC Information Pamphlet.
2. Contact information:
 - A. 4 Hour Service/Quick Reaction Tasking 301-619-7574 DSN 343-7574.
 - B. Unclassified FAX 301-619-2409 or DSN 343-2409. Classified FAX 301-619-2649 or DSN 343-2649.
 - C. AFMIC Bulletin Board Systems Operator 301-619-3883 DSN 343-3883.

D. Message: DIRAFMIC FT DETRICK MD.

E. Correspondence: Director, Armed Forces Medical Intelligence Center, Frederick, MD 21702-5004.

3. Mission. The Defense Intelligence Agency's Armed Forces Medical Intelligence Center located at Fort Detrick in Frederick, Maryland, is the sole source of medical intelligence products within the Department of Defense (DOD). AFMIC maintains a complete database on the medical threat of any area in the world (see FM 8-10-8).
4. AFMIC Products: Infectious Disease Risk Assessments, Environmental Health Risk Assessments, Medical, Environmental, Disease Intelligence and Countermeasures (MEDIC), Medical Capabilities Study (MEDCAP), and AFMIC Wire. To be added to distribution for any AFMIC message product, please send your name, organization, mailing address, routing indicator, plain language address, DSN and Commercial telephone numbers and a brief justification to AFMIC, 1607 Porter Street, Ft Detrick, MD 21702-5004, ATTN: MA-1 or DIRAFMIC FT DETRICK MD//MA-1, DSN 343-3837 or Comm (301) 619-3837.
5. SUBMITTING REQUESTS FOR INFORMATION (RFI'S) TO AFMIC.
 - A. Requests for Information (RFI) is your way of asking AFMIC for answers to questions which are not found in published studies. RFIs should be directed to AFMIC through the Community On-Line Intelligence System for End-Users and Managers (COLISEUM) or by contacting AFMIC Operations at its 24 hour contact number, DSN 343-7574 or Commercial (301) 619-7574. Telephones are secure via STU-III through the TS-SCI level.
 - B. Identify and clarify your medical intelligence needs. Write them down. Check with your intelligence officers (S-2's, G-2's, J-2's, IN's) first; they may already have what you need. Upon mission completion, report items of significance, submit after action reports, tell us whether medical intelligence was correct and met your needs, and submit recommendations for improvement.

8.3. Center for Health Promotion and Preventive Medicine (USACHPPM)

1. Reference: USACHPPM Web pages. <http://chppm-www.apgea.army.mil/>.
2. CHPPM - Main: DSN 584-4375. Commercial is 410-671-4375. Toll free number is 800-222-9698. 24 hour response line 1-888-786-8633. CHPPM - Europe: DSN 486-8369. CHPPM - Pacific: DSN 268-4367.
3. USACHPPM provides technical support for implementing preventive medicine, public health and health promotion/wellness services into all aspects of America's Army and the Army Community anticipating and rapidly responding to operational needs and adaptable to a changing world environment.
4. The professional disciplines represented at the Center include chemists, physicists, engineers, physicians, optometrists, audiologists, nurses, industrial hygienists, toxicologists, entomologists, and many others as well as sub-specialties within these professions.

8.4. U.S. Army Chemical School

1. Reference: <http://www-tradoc.monroe.army.mil/mcclellan/cmlscl.htm>.

2. Address. US Army Chemical School, Ft McClellan, Alabama 36205-5020.
3. Phone number: DSN 865-6438. Intelligence officer 6452/6454.
4. The U.S. Army Chemical School specializes in nuclear, biological and chemical defense doctrine, training, leader development, organizational design and material development.

8.5. US Army Nuclear and Chemical Agency (USANCA)

1. Address: US Army Nuclear and Chemical Agency, 7150 Heller Loop Road, Suite 101, Springfield, VA 22150-3198.
2. Phone number: 703-806-7868/7859. DSN 656-7868/7859.

8.6. Defense Threat Reduction Agency (DTRA)

1. Reference: Web site: www.dtra.mil.
2. The DSN Phone number is 221-7095. Commercial: (202) 325-7095.
3. Under the auspices of the Defense Reform Initiative, DSWA has merged into the new Defense Threat Reduction Agency. DSWA serves as the Department of Defense center for Nuclear and advanced weapons effects expertise. The Agency's mission is to research and develop technologies to support military systems and satisfy operational requirements. DSWA also manages military nuclear weapons stockpile support and conducts programs associated with threat reduction, force protection, arms control technology and counterproliferation support.
4. Defense Nuclear Weapons School. Address: Interservice Nuclear Weapons School, Kirkland Air Force Base, NM 87117. Phone: 505-846-3452. This school puts on several courses on the reaction to nuclear accidents.

8.7. Army Medical Department (AMEDD) Center and School

1. Address: AMEDD Center and School, Fort Sam Houston, TX 78234-5000.
2. Phone number: 210-221-0505.
3. Combat Development. (DSN 471-1020/1364). NBC Sciences Branch. (DSN 471-6011)

8.8. Medical Command (MEDCOM)

1. Address: Medical Command, Fort Sam Houston, TX 78234-6000.
2. Phone number: 210-221-6612, DSN 471-6612.

8.9. HQDA, Office of the Surgeon General

1. Reference: Web page: WWW.nbc-med.org.
2. Address: HQDA, ATTN: DASG-HCO, 5109 Leesburg Pike, Falls Church, VA 22041-3258.
3. Phone number: 703-681-8185, DSN 761-8185.

8.10. Army Materiel Command (AMC)

1. Address: 5001 Eisenhower Avenue, Alexandria, VA 22333-5000.
2. Phone number: 703-274-9375, DSN 284-9375. AMC Surgeon's Office: DSN 767-9370. Operations Center: DSN 284-8406/9223, Commercial: (202) 274-8406/9223.
3. Communications & Electronics Command (CECOM) and SBCCOM are parts of AMC.

8.11. Army Medical Materiel Development Activity (USAMMDA)

1. Reference: <http://www.armymedicine.army.mil/usammda/>.
2. USAMMDA guides the development of equipment for the Army Medical Department.

8.12. Walter Reed Army Medical Center (WRAMC)

1. Address: Walter Reed Army Medical Center, 6825 16th St NW, Washington, DC, 20307-5001.
2. Phone number: 301-427-5161, DSN 291-5161.
3. WRAMC has Radiological Advisory Medical Team.

8.13. 520th Theater Army Medical Laboratory (TAML)

1. Reference: TAML Bulletin.
2. Email: taml@aeha1.apgea.army.mil.
3. Phone: Commercial 410-671-3647. DSN 584-3647. FAX: 410-671-7142.
4. Mission. TAML's mission is to identify and evaluate health hazards in an area of operations by using laboratory analyses and rapid health hazard assessments of nuclear, biological, chemical, endemic disease, environmental and occupational health threats. TAML was activated as a FORSCOM medical surveillance unit under the command and control of the 44th Medical Brigade, XVIII Airborne Corps. The area medical laboratory (AML) will replace the current Theater Army Medical Laboratory (TAML). The reorganization of the laboratory into the AML provides for its employment in the Corps and EAC. The TAML is designed for employment at EAC.

8.14. National Military Command Center (NMCC)

DSN 227-6340. Commercial 703-697-6340.

8.15. Crisis Coordination Center

DSN 364-9320. Commercial 202-769-9320.

8.16. U.S. Navy Command Center

DSN 225-0231. Commercial 703-695-0231.

8.17. U.S. Marine Corps Operations Center

DSN 225-7366. Commercial 703-695-7366.

8.18. U.S. Air Force Operations Center (AFOC)

DSN 227-6103. Commercial 703-697-6103.

8.19. U.S. Army Operations Center (AOC)

DSN 227-0218. Commercial 703-697-0218.

8.20. Director of Military Support

1. Reference: <http://www.dtic.mil/doms/>.
2. The Director of Military Support serves as the Secretary of the Army's action agent for planning and executing DOD's Support Mission to civilian authorities within the United States.

8.21. Chemical/Biological Incident Response Force (CBIRF)

1. Public affairs: 910-451-8118. Operation 910-451-9093.
2. The Marine CBIRF is a strategic organization: manned, trained and equipped to counter the growing chemical/biological terrorist threat. This response force will respond to chemical or biological incidents worldwide, when directed by the National Command Authority, to assist local civilian and military agencies in order to assist the on-scene commander in providing initial post incident consequence management. The CBIRF deploys to incident locations by the most expeditious means possible, where they will coordinate initial relief efforts, provide security and area isolation at the affected site; detection, identification and decontamination; expert medical advice and assistance to local medical authorities; and service support assistance as required. The CBIRF's home base is Camp Lejeune, N.C.

8.22. Tech Escort

1. Public Affairs Office at the United States Army Chemical Biological Defense Command at (410) 671-4345; EPA at (214) 665-6783; or EPA Headquarters at (202) 260-5589.
2. The United States Army Technical Escort Unit provides the Department of Defense and other federal agencies with a unique, immediate response capability for escorting, rendering-safe, disposing, sampling, verifying, mitigating hazards and identifying weaponized and non-weaponized chemical, biological and hazardous material.

8.23. HAMMER Adaptive Communication Element (ACE)

1. HQ Air Force Communications, Special Purposes Communications Division.
2. Hammer ACE is the Air Force's special purpose, quick reaction communication unit that supports worldwide emergency and disaster response forces, civil disaster relief operations, and military exercises and communication equipment testing/evaluation.
3. Duty hours: DSN: 576-3431. Commercial: (618) 256-3431.
4. Non-Duty Hours: Contact Scott AFB, IL Command Post at DSN 576-5891 or commercial (618) 256-5891.

5. Message address: AFC4A SCOTT AFB IL//SYQ//SYQA//INFO AFC4A//CC.

8.24. Assistant Secretary of Defense (Public Affairs)

DSN 227-5131. Commercial 703-697-513 1.

8.25. Joint Nuclear Accident Coordinating Center (JNACC)

1. Reference: TC 3-15.
2. DOD Element: DSN 221-2102/2103 or Commercial: (703) 325-2102/2103.
3. DOE Element: DSN 244-4667 or Commercial: (505) 844-4667.
4. Mission. The joint nuclear accident-coordinating center (JNACC) at the Defense Nuclear Agency will dispatch other radiological assets to aid the incident commander in case of a Broken Arrow. The JNACC is the central agency for the collection, compilation, and maintenance of a nuclear accident response capability (NARCL). It coordinates assistance for accidents or incidents involving radioactive materials, both CONUS and OCONUS.

8.26. Armed Forces Radiobiology Research Institute (AFRRI)

1. Reference: AFRRI's Web Site: www.afri.usuhs.mil.
2. Address. Armed Forces Radiobiology Research Institute, 8901 Wisconsin Avenue, Bethesda, MD 20889-5603.
3. Phone number: 301-295-0530.
4. AFRRI, a tri-service laboratory chartered in 1961, conducts research in the field of radiobiology and related matters essential to the operational and medical support of the U.S. Department of Defense and the military services. The institute collaborates with other governmental facilities, academic institutions, and civilian laboratories in the United States and other countries. Its findings have broad military and civilian applications.
5. Medical Radiobiology Advisory Team (MRAT), 301-295-0316. Worldwide pager No. 1-800 SKY PAGE pin=801 0338.

8.27. Army Radiological Control Team (RADCON)

1. References: TC 3-15.
2. DSN 283-6934 or Commercial: (202) 472-5107.
3. Mission: Response to radiological accidents and incidents, worldwide: special weapons, depleted uranium munitions, and all radioactive materials. The Army RADCON team is a follow-on organization, supporting the response to Broken Arrows. The RADCON team's equipment and expertise can begin to give the commander detailed and reliable information about radiological hazards. RADCOM is under CECOM, which is under AMC.
4. RADCOM Assets: 20 personnel, expandable ISO shelter, alpha/beta counting system, liquid scintillation, multichannel analyzer.

8.28. Department of the Army Radiation Safety Office

1. DSN 225-7291.
2. At HQDA, Safety Office.

8.29. Industrial Operations Command (IOC)

1. Director, HQ, IOC, ATTN: AMSIO-DMW, Rock Island, IL, 61299-7630.
2. DSN 793-0388/2969/1766. Commercial (309) 782-0338/2969/1766.
3. The Industrial Operations Command (IOC) has been designated by AR 385-11 as the responsible command for the safe disposal of all unwanted, low-level radioactive material in the US Army. Specifically, the IOC's Radioactive Waste Disposal office (AMSMC-RW) has been appointed the Program Manager. AMSMC-RW is accountable for providing information and guidance to all US Army "generators" of unwanted radioactive material to prevent violation of Federal and State regulations, thereby assuring safe and legal transport and burial of the material.

8.30. United States Army Ionizing Radiation Dosimetry Center (USAIRDC)

1. Address: US Army Ionizing Radiation Dosimetry Center, ATTN: AMSMI-TMDE, Redstone Arsenal, AL 35898-5400.
2. USAIRDC provides dosimetry support to the U.S. Army.

8.31. US Army Armament and Chemical Acquisition and Logistics Activity (ACALA)

1. Director, ACALA, ATTN: AMSTA-AC-SF, Rock Island, IL 61299-7630.
2. COM 309-782-2962/2965, DSN 793-2962/2965. FAX COM 309-783-6758, FAX DSN 793-6758.

8.32. Radiological Advisory Medical Team (RAMT)

1. Mission: Provide medical/technical advice and detection equipment for the treatment of radiologically contaminated patients to on-scene health care or medical treatment facilities.
2. Walter Reed Hospital: DSN 291-5107 or Commercial: (301) 427-5107.
3. Landstuhl - Europe : Military Ext. 2223-7387 or Commercial: (from CONUS) 49-6371-86-7387 (in Germany) 06371-86-7387.

8.33. Medical Research Institute of Chemical Defense (USAMRICD)

1. Reference: USAMRICD's Web Site: <http://chemdef.apgea.army.mil/>.
2. Address: Commander, U.S. Army Medical Research Institute of Chemical Defense, 3100 Ricketts Point Road, Aberdeen Proving Ground, MD 21010-5425.
3. Telephone number: 410-671-3628 or DSN 584-3628. FAX : 410-671-1960 or DSN 584-1960.

4. Mission. The U.S. Army Medical Research Institute of Chemical Defense is the nation's lead laboratory for research to advance the medical prevention and treatment of chemical warfare casualties. The Institute also has a clinical training mission and conducts the Medical Management of Chemical Casualties Course for health care providers from all armed services.
5. Electronic mail: General Institute Research Information: Program and Information Management Branch (USAMRICD_PAO@ftdetrck-ccmail.army.mil). Information concerning Medical Management of Chemical Casualties training: Chemical Casualties Care Office (ChemCasCare@ftdetrck-ccmail.army.mil).

8.34. Armed Forces Institute of Pathology (AFIP)

1. Web page: www.afip.org.
2. AFIP is a tri-service agency of the Department of Defense with a threefold mission of consultation, education, and research. Within the institute there are 22 subspecialty departments with more than 120 pathologists.

8.35. Medical Research Institute of Infectious Diseases (USAMRIID)

1. Reference: USAMRIID's Web Site: www.usamriid.army.mil/html/home/home.html.
2. Telephone: 301-619-2285. FAX: 301-619-4625.
3. Postal address: USAMRIID, 1425 Porter Street, FORT DETRICK, FREDERICK, MD 21702-5011.
4. Mission. RIDD conduct research to develop strategies, products, information, procedures, and training programs for medical defense against biological warfare (BW) agents and naturally occurring agents of military importance that require special containment.

8.36. Walter Reed Army Institute of Research (WRAIR)

1. Reference: WRAIR's Web site. www.wrair.army.mil.
2. Telephone. (202) 782-7580, or DSN 662-7580.
3. Mission. The WRAIR's goal is to prevent illnesses and injuries, enhance human performance, and improve survivability on the battlefield. The Institute has produced many safe and effective drugs and vaccines, medical devices, diagnostic tests, and other much needed medical products, as well as obtained invaluable medical information that supports specific service policies.
4. US Army Medical Research Detachment of WRAIR is located at Brooks Air Force Base, San Antonio, TX. The detachment can provide expertise in the medical effects, symptoms and treatment of both laser and radiofrequency injuries. The message address for the detachment is DIRUSAMRD BROOKS AFB TX //MCMR-UWB-L//.

8.37. Centers for Disease Control and Prevention (CDC)

1. Reference: CDC's Web site: www.cdc.gov.
2. Address: Centers for Disease Control and Prevention, 1600 Clifton Rd., NE, Atlanta, GA 30333.

3. Phone number: (404) 639-3311.
4. Expertise with diagnostic testing, sample management, disease pathogenesis, and treatment.
Mission: To promote health and quality of life by preventing and controlling disease, injury, and disability. CDC is an agency of the Department of Health and Human Services. The CDC includes 11 centers, institutes, and offices with approximately 6900 employees in 170 occupations.
5. Agency for Toxic Substances and Disease Registry (ATSDR), Division of Toxicology, 1600 Clifton Road NE, E-29, Atlanta, GA 30333.

8.38. Nuclear Regulatory Commission (NRC)

1. Reference: Web site: www.nrc.gov.
2. Address: Nuclear Regulatory Commission, 11555 Rockville Pike, Rockville Pike, MD. 20852-2738.
3. Phone number: 301-415-5385.

8.39. Radiation Emergency Assistance Center/Training Sites (REAC/TS)

1. Address: Radiation Emergency Assistance Center, Oak Ridge Associated Universities, Oak Ridge, TN 37831-0117.
2. Phone number: 615-576-3131.

8.40. Government Accounting Office (GAO)

Web page: www.gao.gov.

8.41. Federal Emergency Management Agency (FEMA)

1. Web page: www.fema.gov/index.htm.
2. FEMA's mission is to reduce loss of life and property and protect our nation's critical infrastructure from all types of hazards through a comprehensive, risk based, emergency management program of mitigation, preparedness, response, and recovery.

8.42. National Emergency Coordinating Center (NECC)

DSN 380-6100. Commercial 202-898-6100.

8.43. Emergency Information and Coordination Center (EICC)

DSN 544-7721/7720. Commercial 202-646-2400.

8.44. Department of State - Operations Center

Commercial 202-647-1512.

8.45. HQ DoE Emergency Operation Center

Commercial 202-586-8100.

8.46. US Department of Energy's Public Affairs Guidance

DSN: 244-6938 or Commercial: 505-844-6938.

8.47. Domestic Preparedness Web Page

<http://www.nbc-prepare.org>.

Glossary of Terms and Acronyms

A.

ABOs - Agents of biological origin.

Absorbed dose - The energy imparted by ionizing radiation per unit mass of irradiated material. The units of absorbed dose are the rad and the gray (Gy).

ACALA - US Army Armament and Chemical Acquisition and Logistics Activity.

ACE - Allied Command Europe.

AE - Aeromedical Evacuation.

AFMIC - US Armed Forces Medical Intelligence Center.

AFRRI - Armed Forces Radiobiology Research Institute.

Afterimage - A reverse contrast, shadow image left in the visual field after a direct exposure to a bright light, such as a laser pointer.

Aidman Vision Screener - Informal test that can be used to assess the function of the eye by an army medic.

AIRDC - US Army Ionizing Radiation Dosimetry Center.

ALARA - As Low As Reasonably Achievable.

Alpha particle - A type of particle that can be emitted during a radioactive decay.

Alpha Probe - A probe used to measure the presence of alpha particles.

AMC - US Army Materiel Command.

AMEDD - Army Medical Department.

AMEDD C&S - Army Medical Department Center and School.

Amsler Grid - Foveal Grid Test, used to determine visual irregularities.

Anorexia - Lack or loss of the appetite for food.

Antibody - A protein synthesized by an animal in response to the presence of a foreign substance or an immunoglobulin molecule synthesized on exposure to antigen, which can combine specifically with that antigen.

Antigen - A substance that can induce an immune response. Proteins, polysaccharides, and nucleic acids are effective antigens.

Anuria - Absence of excretion of urine from the body.

Aphonia - Loss of speech resulting from disease or injury to the speech organs.

Areflexia - Absence of reflexes.

ARTEP - Army Training and Evaluation Program.

Arthralgia - Pain in a joint.

ASGs - Area Support Groups.

Asthenia - Lack or loss of strength and energy.

Ataxia - Inability to coordinate muscular movements.

ATSDR - Agency for Toxic Substances and Disease Registry.

Autonomic - Self -controlling.

B.

Bacteremia - The presence of bacteria in the blood.

Bacteria - Free-living organisms consisting of nuclear material, cytoplasm, and a cell membrane that divide by simple division.

BAS - Battalion Aid Station.

BDO - Battle Dress Overgarment.

BDU - Battle Dress Uniform.

Beta Particle - An electron emitted from a nucleus during a radioactive decay. Beta radiation is a skin hazard in addition to being an internal hazard.

Bioassay - Radiological bioassay is the determination of the kind, quantity, or concentration and location of radioactive material in the human body by direct measurement or analysis of materials excreted or removed from the body.

Biological Agent - A microorganism (or toxin derived from it) which causes disease in man, plants or animals or which causes deterioration of material.

Biological Defense - Biological defense comprises the methods, plans and procedures involved in establishing and executing defensive measures against.

Biological Weapon - An item of material that projects, disperses, or disseminates a biological agent; including arthropod vectors.

Blepharospasm - Uncontrollable winking caused by involuntary contraction of an eyelid muscle.

BLPS - Ballistic / Laser Eye protection.

Bradycardia - Abnormally slow heartbeat.

Broken Arrows - An accident involving nuclear weapons. While it is almost impossible for the warhead to accidentally detonate, the accident may spread radioactive contamination over a wide area.

Bronchitis - Acute or chronic inflammation of the mucous membrane of the bronchial tubes.

Bubo - Inflammatory swelling of one or more lymph nodes, the confluent mass of nodes usually suppurates and drains pus.

Bubonic - Characterized by or pertaining to buboes.

BW - Biological Warfare.

C.

Calcium Hypochlorite - A decontaminant to be used only if STB is not available.

CAM - Chemical Agent Monitor.

CARM - Chemical agent resistant material.

CBIRF - Navy/Marine Corps Chemical /Biological Incident Response Force.

CBPS - Chemically and Biologically Protected Shelter.

CDC - Centers for Disease Control and Prevention.

CFR - Code of Federal Regulations.

CG - Phosgene.

Chemical Agent - Substance that is intended for use in military operations to kill, seriously injure or incapacitate people because of its physiological effects. Excluded from this definition are riot control agents, herbicides, smoke, and flame.

Chemical Dosimeter - A type of dosimeter that uses a chemical change to measure the radiation.

Chemoprophylaxis - Administration of a chemical to prevent the development of an infection or the progression of an infection to active manifest disease.

Chemotherapy - use of a chemical to cure a clinically recognizable disease or to limit further disease progress.

CHL - Combat Health Logistics.

Chlamydia - A genus of the family Chlamydiaceae occurring as two species which cause a wide variety of diseases in man and animals. Obligatory intracellular parasites that grow only within living cells.

Choroid - Highly vascularized layer of eyeball which lies between the retina and the sclera.

CHPPM - See USACHPPM.

CHS - Combat Health Support.

CIA - Central Intelligence Agency.

CINC - Commander(s) in Chief.

CN - Chloroacetophenone, a irritant agent.

COLPRO - Collective protection.

COMMZ - Communications Zone.

Conjunctival - Pertaining to the conjunctiva.

Cornea - The cornea is the transparent front part of the eye that separates it from the air.

COSCOM - Corps Support Command.

CP DEPMED - The Chemically Protected Deployable Medical System.

CS - Combat Support.

CS - O -Chlorobenzylidene Malononitrile, a irritant agent.

CSR - Combat Stress Reaction.

CSS - Combat Service Support.

Cutaneous - Pertaining to the skin.

CW - Chemical Warfare.

CW - Continuous wave.

CX - Phosgene oxime.

Cyanosis - Bluish discoloration of the skin, caused by inadequate oxygenation of the blood, evident when reduced hemoglobin in the blood exceeds 5g per 100ml.

CZ - Combat Zone.

D.

DA - Department of Army.

Dazzle - A temporary loss of vision or a temporary reduction in visual acuity due to exposure to a bright light source.

DCA - Division Clearing Station.

DE - Directed Energy.

Defervescence - The period of abatement of fever.

Defoliant - Chemical used to kill plants and trees.

Depleted Uranium - A mixture of uranium metal used in armor piercing rounds and in tank armor.

DEPMED - The Chemically Protected Deployable Medical System.

Dermatitis - Inflammation of the skin.

DEW - Directed Energy Weapon.

DIA - Defense Intelligence Agency.

Diaphoresis - Perspiration, especially profuse perspiration.

Diathesis - Condition in which tissues reacts in special ways to certain extrinsic stimuli and thus tends to make the person more susceptible to certain diseases.

Diplopia - Double vision.

Divergence - A description of how fast a laser beam spreads over distance.

DLA - Defense Logistics Installations.

DNBI - Disease and Non -Battle Injuries.

Dosimeter - An instrument for measuring the total amount of radiation absorbed in a given time. Worn by an individual to record the exposure of that person to radiation.

DSA - Division Support Area.

DSWA - Defense Special Weapons Agency.

DTRA - Defense Threat Reduction Agency

DU - Depleted Uranium. DU is a mixture of uranium metal used in armor piercing rounds and in tank armor.

Dysarthria - Imperfect articulation of speech due to disturbances of muscular control which result from damage to the central or peripheral nervous system.

Dysphagia - Difficulty in swallowing.

Dysphonia - Any impairment of voice.

Dyspnea - Difficult or labored breathing.

E -F -G -H.

EAC - Echelons above corps

Ecchymoses - Small hemorrhagic spots in the skin or mucous membrane forming non -elevated, rounded or irregular, blue or purplish patches.

Edema - The presence of abnormally large amounts of fluid in the intercellular tissue spaces of the body.

ELISA - Enzyme Linked Immunosorbent Assay. An immunological test that uses enzyme -linked antiglobulins and substrate bound to the walls of polystyrene tubes.

Emesis - Vomiting.

EMP - Electromagnetic Pulse

Endemic - Constant presence of a disease or infectious agent within a given geographic area. The usual prevalence of a given disease within such an area.

Enterotoxin - An exotoxin produced by certain species of bacteria that causes various diseases. Toxin specific for the cells of the intestinal mucosa.

Enzyme linked immunosorbent assay - See ELISA.

EPA - Environmental Protection Agency.

Epidemic - Occurrence in a community or region of cases of an illness or outbreak clearly in excess of expectancy.

Epididymo -orchitis - Inflammation of the epididymis and testis.

Epistaxis - Nosebleed; hemorrhage from the nose.

Epizootic - Any disease of animals that attacks many animals in the same area.

Eructation - An act of belching.

Erythema - A redness of the skin.

Etiologic - Pertaining to the cause of disease.

Exotoxin - Soluble toxins, usually produced by gram-positive bacteria that have a specific toxic effect. These toxic substances are found outside the bacterial cell, or free in the culture medium.

Far -IR - See infrared.

Fasciculations - A small local contraction of muscles, visible through the skin, representing a spontaneous discharge of a number of fibers innervated by a single motor nerve filament.

FDA - Food and Drug Administration.

Fission - A nuclear process in which a heavier nucleus divides or splits into two or more lighter nuclei.

Flaccid - Weak, lax, and soft.

Flashblindness - A temporary visual interference effect that persists after the source of

illumination has been removed. This is similar to the effect produced by flashbulbs, and can occur at exposure levels below those that cause eye damage.

Fluctuant - Showing varying levels.

Fomite - Objects that possibly harbor a disease agent and are capable of transmitting that disease (clothing, utensils).

FRAGO - Fragmentary order.

Fulminant - Sudden, severe.

Fungi - Primitive plants which do not utilize photosynthesis and are capable of anaerobic growth. Most fungi form spores.

Fusion - Generally regarded as the opposite of fission. The joining of nuclei to form a heavier nucleus.

G2 - See S2/G2.

G5 - See S5/G5.

GA - Tabun. A nerve agent.

GaAIs - Gallium -Aluminum -Arsenide (LASER medium).

Gamma Photon - Electromagnetic radiation originating from the nuclei of decaying atoms.

GB - Sarin. A nerve agent.

GD - Soman. A nerve agent.

Geiger Counter - An instrument used for detecting radiation.

Genome - The complete set of hereditary factors, as contained in the haploid assortment of chromosomes.

Glare - The temporary loss of vision due to exposure to a bright light source. Vision returns to normal soon after the light source is turned off.

Gram-stain - divides most bacteria into two groups. The gram-reaction depends on the ability of certain bacteria (Gram-positive) to retain a complex of a purple dye and iodine when briefly washed with alcohol. Gram-positive bacteria protect their membrane with a thick cell wall made of peptidoglycan. Gram-negative bacteria do not retain the dye and can be counterstained red.

Gray (Gy) - The SI unit of absorbed dose. One gray is equal to an absorbed dose of 1 J kg⁻¹ (100 rad).

H - Mustard. A blister agent.

Half Life - The time in which half the atoms of a particular radioactive substance disintegrate to another nuclear form.

HAZMAT - Hazardous Material.

Hematogenous - Produced by or derived from the blood.

Hematuria - Blood in the urine.

Hemolysis - Separation of the hemoglobin from the red blood cells and its appearance in the plasma.

HN - Host Nation.

Host Nation - A nation that receives the forces and/or supplies of allied nations and/or NATO to be located on, or to operate in, or to transit through its territory.

HSS - Health Service Support.

HTH - See Calcium Hypochlorite.

Hyperemia - An excess of blood in a part.

Hypertension - Persistently high arterial blood pressure.

Hypoplasia - Incomplete development or underdevelopment of an organ or tissue.

Hypotension - Abnormally low blood pressure.

Hypovolemia - Abnormally decreased volume of circulating fluid in the body.

Hypoxemia - Deficient oxygenation of the blood (hypoxia).

Hypoxia - Low oxygen content or tension.

I

ICRP - International Council on Radiological Protection.

Icterus - Jaundice.

Ileus - Obstruction of the intestines.

Immunity - The resistance usually associated with presence of antibodies or cells having specific action on the microorganism concerned with a particular infectious disease or its toxin.

Immunoassay - The measurement of antigen - antibody interaction.

Immunoglobulin - The class of glycoproteins with antibody activity.

Incubation period - Time interval between initial contact with an infectious agent and appearance of first symptoms of the disease.

IND - Investigational New Drug.

Infarction - An area of coagulation necrosis in a tissue due to local ischemia resulting from obstruction of circulation to the area, most commonly by a thrombus or embolus.

Infection – Entry and development or multiplication of an infectious agent in the body of man or animals. Infection is not synonymous with infectious disease, result may be inapparent or manifest.

Infectious agent – Organism (virus, rickettsia, bacteria, fungus, protozoa, or helminth) that is capable of producing infection or infectious disease.

Infectivity – Producing or capable of producing infection.

Infrared - Infrared radiation is radiation with wavelengths between 760 nanometers –1 millimeter. Most of the lasers and night vision devices used by the Army operate in this region.

Investigational New Drug - A drug that has not received full FDA approval and can only be used with written approval of the patient.

IOC - Industrial Operations Command.

Ionizing radiation - Radiation that has sufficient energy to remove electrons from atoms.

IPE - Individual Protective Equipment.

IR - See Infrared.

Irradiance - The power per unit of energy produced by a laser transmitted to the surface of the skin, eye, or into the eye.

Isotope - Atoms of the same element may have different numbers of neutron in their nuclei, these are called isotopes of the element. Tritium is an isotope of Hydrogen.

J -K -L.

J - Joules. A measure of energy.

Labile - Chemically unstable.

Lacrimation - The secretion and discharge of tears.

LASER - Light Amplification by Stimulated Emission of Radiation.

Lens - A transparent, biconvex, nearly spherical body in the eye which focuses light passing through the pupil (images) onto the retina.

Leukopenia - Reduction in the number of leukocytes (white blood cell) in the blood, the count being 5000 or less.

LLR - Low Level Radiation

Lymphadenitis - Inflammation of lymph nodes.

M.

Macrophage - Any of the large, highly phagocytic cells occurring in the walls of blood vessels and in loose connective tissue.

Macular – Discolored spot on the skin that is not elevated above the surface.

MCDM - Medical Chemical Defense Material.

MEDCOM - US Army Medical Command.

Mediastinal - Pertaining to the median septum or partition.

Melena - The passage of dark, pitchy, and grumous stools stained with blood pigments or with altered blood.

Meningitis - Inflammation of the meninges (the membranes that envelop the brain and spinal cord).

METT -T - Mission, enemy, terrain, troops, and time available.

Micturition - Urination.

Miosis - Contraction of the pupil.

MOPP - Mission Orientated Protective Posture.

MOU - Memorandum of Understanding.

MRA/MSA - Mid -range agents / mid spectrum agents.

MRICD - See USAMRICD.

MRIID - See USAMRIID.

MSMC - Main support medical company.

MTF - Medical Treatment Facility.

MTOE - Modified Table of Organization and Equipment.

Muscarinic effects - Relating to, resembling, producing, or mediating the parasympathetic effects such as a slowed heart rate and increased activity of smooth muscle.

Myalgia - Pain in the muscles.

Mydriasis - Extreme or morbid dilation of the pupil.

Myonecrosis - Necrosis or death of individual muscle fibers.

N.

NAAK Mark 1 - Nerve Agent Antidote Kit.

NAIRA - Nuclear Accident and Incident Response and Assistance.

NAPP - Nerve Agent Pre-treatment Tablets (also referred to as NAPS).

NATO - North Atlantic Treaty Organization.

NCRP - National Council on Radiation Protection and Measurements.

Nd:YAG - Neodymium:Yttrium -Aluminum - Garnate (LASER medium).

Near-IR - See infrared.

Necrosis - Death of tissue, usually as individual cells, groups of cells, or in small localized areas.

Necrotic - Pertaining to or characterized by necrosis.

Neuropathy - A general term denoting functional disturbances and/or pathological changes in the peripheral nervous system.

Neutron - An electrically neutral particle associated with the nucleus of an atom and having an atomic mass number of 1, and symbol n.

Nicotinic - Relating to, resembling, producing, or mediating the effects produced by nicotine on nerve fibers at autonomic ganglia and at the neuromuscular junctions of voluntary muscle which increase activity in small doses and inhibits it in larger doses.

nm - Nanometer (1 billionth of a meter).

NOHD - Nominal Ocular Hazard Distance.

Non-ionizing Radiation - Radiation that has insufficient energy to remove electrons from atoms. Laser and Radiofrequency radiation is considered non-ionizing radiation.

Non-persistent - Non-persistent chemical agents disperse rapidly after release and present an immediate, short duration hazard.

NRC - Nuclear Regulatory Commission.

NSN - National Stock Number.

Nuclei - See nucleus.

Nucleus - The center of an atom consisting of protons and neutrons.

O-P-Q-R.

Obtundation - Dulling.

OEG - Operation Exposure Guidance.

Oliguria - Secretion of a diminished amount of urine in relation to the fluid intake.

OOTW - Operations Other Than War.

Orthopnea - Difficult breathing except in an upright position.

OSLR - Operationally Significant Level of Radiation.

Osteomyelitis - Inflammation of bone caused by a pyogenic organism.

OTSG - The US Army Office of the Surgeon General.

Pallor - Paleness; absence of skin color.

Pannus - Superficial vascularization of the cornea with infiltration of granulation tissue.

Papule - A small circumscribed, superficial, solid elevation of the skin.

Parenchyma - The essential elements of an organ; used in anatomical nomenclature as a general term to designate the functional elements of an organ, as distinguished from its framework.

Pathogenicity - The capability of an infectious agent to cause disease in a susceptible host.

PB - Pyridostigmine Bromide.

PCPS - Portable Collective Protection System.

PEL - Permissible Exposure Limit.

Persistance - Persistent chemical agents continue to present a hazard for considerable periods after delivery.

Petechiae - Pinpoint, nonraised, perfectly round, purplish red spot caused by intradermal or submucous hemorrhage.

Photophobia - Abnormal visual intolerance of light.

Pleural - Pertaining to the serous membrane investing the lungs and lining the thoracic cavity.

Pneumonic - Pertaining to the lung or to pneumonia.

POC - Point of Contact.

Power Density - See Irradiance.

Prodrome - A symptom indicating the onset of a disease.

Prostration - Extreme exhaustion or powerlessness.

Ptosis - Prolapse of an organ or part.

Pustule - A visible collection of pus within or beneath the epidermis, often in a hair follicle or sweat pore.

PVNTMED - Preventive Medicine.

Quarantine - Restriction of activities of persons who have been exposed to a communicable disease during the period of communicability in order to prevent disease transmission during the incubation period.

RADCON - Radiological Control Team.

Radioactive isotopes - Isotopes of a given element that are radioactive.

Radioactive decay - The process wherein radioactive isotopes emit ionizing radiation and transform into different elements.

Radioactivity - The property possessed by some elements (as uranium) or isotopes (as carbon-14) of spontaneously emitting energetic particles such as alpha or beta particles, often accompanied by gamma rays, by the disintegration of their atomic nuclei.

Radioisotope - See radioactive isotope.

Radionuclide - See radioactive isotope.

Rales - Abnormal respiratory sound heard in auscultation, and indicating some pathological condition.

RAMT - Radiological Advisory Medical Team.

RDD - Radiation Dispersal Device.

RDW - Radiation Dispersal Weapon.

REAC - Radiation Emergency Assistance Center/Training Sites.

RES - Radiation Exposure Status.

Retina - The back inside portion of the eye where images are formed.

Retrosternal - Situated or occurring behind the sternum.

RF - Radiofrequency.

Rhinorrhea - The free discharge of a thin nasal mucus.

Rickettsiae - Organisms that have metabolic enzymes and cell membranes but only grow within living cells.

Rigors - Chills.

RIID - See USAMRIID.

ROTA - Releases Other Than Attack.

ROWPU - Reverse Osmosis Water Purification Unit.

RPO - Radiation Protection Officer.

RSO - Radiation Safety Officer.

RTAP - Real Time Analysis Platform.

RTD - Return to duty.

RTM - Real Time Monitors.

S.

S2/G2 - Intelligence section on the command staff of the unit.

S5/G5 - Civil Affairs section on the command staff of the unit.

Sacroiliitis - Inflammation in the sacroiliac joint.

SAR - Specific Absorption Rate.

SATCOM - Satellite Communications.

SBCCOM - Soldier and Biological Chemical Command.

SCBA - Self-Contained Breathing Apparatus.

Sclera - The tough white outer coat of the eyeball.

Scotoma - Blind or dark spot in the visual field.

Septicemic - Pertaining to a systemic disease associated with the presence and persistence of pathogenic microorganisms or their toxins in the blood.

Sequelae - Any lesions or affections following or caused by an attack of disease.

SOP - Standing Operating Procedures.

SSCOM - Soldier System Command.

STANAG - See NATO STANAG.

STB - Super Tropical Bleach. A decontaminant.

Sternutator - A substance that irritates the nasal and respiratory passages and causes coughing and sneezing.

Stridor - A harsh, high-pitched respiratory sound such as the inspiratory sound often heard in acute laryngeal obstruction.

Subretinal hemorrhage - A collection of blood between the retina and the choroid.

Synapses - The anatomical relation of one nerve cell to another.

T.

TA - Theater Army.

TAACOMs - Theater Army Area Commands.

Tachycardia - Excessive rapidity in the action of the heart.

TAML – 520th Theater Army Medical Laboratory.

TB - US Army Technical Bulletin.

TEMPER Tent – An expandable lined tent.

Tenesmus - Straining, especially ineffectual and painful straining at stool or in urination.

Thrombocytopenia - Decrease in the number of blood platelets.

Thrombosis - The formation, development, or presence of a thrombus (clot).

TIC - Toxic Industrial Chemicals.

TIM - Toxic Industrial Material.

TLD - Thermoluminescent dosimeter.

TOE - Table of Organization and Equipment.

Toxic Industrial Chemicals - Chemicals from industrial processes that pose hazards to individuals.

Toxic Industrial Material – Materials such as chemicals and radioactive material from industrial processes that pose hazards to individuals.

Toxin - A poisonous substance produced or derived from living plants, animals, or microorganisms; some toxins may also be produced or altered by chemical means. In many aspects, they are comparable to chemical agents.

Tritium - A radioactive isotope of hydrogen.

U - V - W - X - Y - Z.

Ultraviolet - Ultraviolet radiation is radiation with wavelengths between 180 -400 nanometer.

USACHPPM - US Army Center for Health Promotion and Preventive Medicine.

USAIRDC - US Army Ionizing Radiation Dosimetry Center.

USAMRICD - US Army Medical Research Institute of Chemical Defense.

USAMRIID - US Army Medical Research Institute of Infectious Diseases.

USANCA - US Army Nuclear and Chemical Agency.

UV - See Ultraviolet.

Vaccine - A suspension of living or inactivated organisms used as an antigen in order to confer immunity.

Vector - A carrier, especially the animal which transfers an infective agent from one host to another.

Vesicant - Causing blisters.

Viremic - The presence of viruses in the blood.

Virulence - The degree of pathogenicity of an infectious agent, indicated by case fatality rates and/or its ability to invade and damage tissues of the host.

Virus - Organisms consisting of RNA or DNA surrounded by a protective protein shell which require living cells to replicate. They are dependent on the host cells energy yielding and protein synthesizing apparatus.

Visible Light - Visible is radiation with wavelength between 400 - 800 nanometer.

Vitreous hemorrhage - A collection of blood within the vitreous humor.

Vitreous humor - A jelly-like substance that fills the area of the eye between the lens and retina.

W - Watts. A measure of power.

Wavelength - The distance between the peaks of any two consecutive waves.

WHO - World Health Organization

WMD - Weapons of Mass Destruction.

WRAIR - Walter Reed Army Institute of Research.

WRAMC - Walter Reed Army Medical Center.

X-Ray - Electromagnetic radiation originating from the electron shells surrounding atoms.

Zoonosis – an infection or infectious disease transmissible under natural conditions from vertebrate animals to man.

Zoonotic - Pertaining to disease of animal that may be transmitted to man.

REFERENCES

Topics Covered by References

TOPIC	SUBTOPICS	MANUAL
Nuclear Weapon	Accidents	TC 3-15, NARCL, NARP
Biological Agents		TM 3-216 USAMRIID's book
Casualty Predictions for NBC		NATO AmedP-8
Chemical Agent	Blister, Incapacitating, and Lethal All	FM 3-9 USACHPPM's TG 218
Chemical Corps Units	Command and support relationships Chemical unit employment	FM 3-100 FM 3-101
Contamination Avoidance	Chemical/biological defensive measures Nuclear contamination avoidance	FM 3-3 FM 3-3-1
Decontamination	General decontamination Patient decontamination	FM 3-5 FM 8-10-7
DU - Depleted Uranium	Response to Accidents	TB 9-1300-278
Field behavior of NBC Agents	All	FM 3-6
Fixed site NBC defense	All	FM 3-4-1
Medical Management	All Chemical Chemical Biological	FM 8-9 FM 8-285 USAMRICD's book USAMRIID's book
NBC reconnaissance	Principles Special Fox unit employment	FM 3-19 FM 3-18 FM 3-101-2
Medical Operations		FM 8-10-series
Operations	All	JP 3-11 FM 3-100
Preventive Medical		FM 21-10
Protection	Principles MOPP analysis	FM 3-4 FM 3-4
Radiological Hazards	All	USACHPPM's TG 236, 238, and 239
Toxins	Technical aspects	FM 3-9

Reference: Appendix D from TC 3-10.

Web Sites of Interest

Military	
www.nbc-med.org	Medical NBC Web Site
www-cgs.army.mil/cold	Command and General Staff College
www-ssn.ria.army.mil	Army TMs
www.atsc-army.org	FMs Online
www-usappc.hoffman.army.mil	ARs and DA PAMs
www.geocities.com/pentagon/2701	ESO web site
www.ftmc-marine.army.mil/nbc/nbc.htm	Nuclear, Biological and Chemical Defense School, Fort McClellan
www.cbiac.apgea.army.mil/	Chemical and Biological Defense Information Analysis Center
www.apgea.army.mil/RDA/erdec/index.html	Edgewood Chemical Biological Center
www.apgea.army.mil	US Army Soldier and Biological Chemical Command (SBCCOM)
www-sscom.army.mil	Soldier Systems Command (SSCOM)
206.156.10.15/gobook/gobook.html	Summary of vaccines and drugs that are available from the U.S. Army Medical Research and Materiel Command (USAMRMC)
chppm-www.apgea.army.mil	US Army Center for Health Promotion and Preventive Medicine
	Army Medical Department Center and School
Federal Government	
www.dot.gov	Department of Transportation
www.ntp.doe.gov	Department of Energy
www.epa.gov/cincl	EPA publications
www.epa.gov/radiation/federal.index.html	EPA Radiation documents
www.eml.doe.gov/procman/intro.htm	EML procedures manual
www.access.gpo.gov	Government documents
www.nrc.gov/NRC/RG/index.html	NRC Reg Guides
References	
www.ncrp.com	National Council on Radiation Protection
www.elsevier.com	ICPR's Online
www.ntp.org.uk	Nuclear Protection Technologies Journal
www.nap.edu	National Academy Press, Books

General References:

- ACALA's *Radioactive Material Handling Safety – Student Reference Guide*. This reference guide outlines the basics of radiation and radiation protection. It focuses on radiation sources in U.S. Army commodities. There is a CD version of the Guide.
- ACE Directive 75-3. *NBC Defense Organization*. Equipment and Training for ACE Headquarters and Formations under OPCON of SACEUR
- ACE Directive 80-14. *Nuclear, Biological and Chemical Defense Equipment Operational Guidelines*.
- ACE Directive 80-63. *ACE Policy for Defensive Measures against Low Level Radiological Hazards during Military Operations*.
- ACE Directive 80-64. *ACE Policy for Defensive Measures against Toxic Industrial Chemical Hazards during Military Operations*.
- Addendum Test Report for the Production Qualification Test (PQT) of the ALPHA RADIAC Set, AN/PDR-77, Nuclear Effects Directorate, White Sands Missile Range.
- AFMIC's *Identification of Radiation Sources in a Peacetime Environment*. PC-1811-1-96. May 1996.
- AMEDD Center and School, *Effects of Nuclear Weapons and Directed Energy on Military Operations*, Correspondence Subcourse MD0447. December 1995.
- AMEDD Center and School, GR 76-332-200.
- AMEDD Center and School, *NBC General Reference for the Officer Basic Course*. July 1993.
- American Conference of Governmental Industrial Hygienists, 1995-1996 *Threshold Limit Values (TLVsTM) for Chemical Substances and Physical Agents and Biological Indices (BEIsTM)*.
- American National Standard for the Safe Use of Lasers, ANSI Z136.1, 1993
- AR 40-5. *Preventive Medicine*. 15 October 1990.
- AR 40-61. *Medical Logistics Policies and Procedures*. 30 April 1986 (Change 1, August 1989).
- AR 40-66. *Medical Records Assurance Administration*. 1 June 1992.
- AR 40-400. *Patient Administration*. 1 October 1983.
- AR 40-535. *Worldwide Aeromedical Evacuation*. AFR 164-5;
- AR 40-562. *Immunizations and Chemoprophylaxis*. NAVMEDINST 6230.3; AFR 161-13; CGCOMDTINST M6230.MD. 7 October 1988.
- AR 40-656. *Veterinary Surveillance Inspection of Subsistence*. 15 October 1986.
- AR 40-657. *Veterinary/Medical Food Inspection and Laboratory Service*. 19 May 1989.
- Benenson, A. S. *Control of Communicable Diseases in Man*. American Public Health Association, 15th edition. Washington, DC. 1990.
- Bolz, R.E. and G.L. Tuve. *CRC Handbook of tables for applied engineering science* (2nd Edition edn). CRC Press, Boca Raton, FL. 1973.

- Brodsky, A., *Review of Radiation Risks and Uranium Toxicity with Application to Decisions Associated with Decommissioning Clean-up Criteria*, RSA Publications, Hebron CT, 1996.
- CECOM-TR-94-11. *Radiation Protection Information for the Safe Handling of Tritium Sources in Radioluminescent Devices*. CECOM Safety Office, January 1996.
- Committee on the Biological Effects of Ionizing Radiation, *Health Effects of Low Levels of Ionizing Radiation*, BEIRV, National Academy Press, Washington D.C., 1990.
- Conklin, J. J., and R. I. Walker, Eds. *Military Radiobiology*, Academic Press, 1987.
- DOD, NBC Defense, Fact Sheets.
- DODI 6055.11. *Protection of DoD Personnel from Exposure to Radiofrequency Radiation and Military Exempt Lasers*. 21 February 1995.
- Dorland's Medical Dictionary, 25th Edition, 1974.
- Eisenbud, M. and T. Gesell. *Environmental Radioactivity from Natural, Industrial, and Military Sources* - 4th Edition, Academic Press, San Diego, 1997.
- FM 1-102. *Army Aviation in an NBC Environment*. 30 September 1985.
- FM 3-3. *Chemical and Biological Contamination Avoidance*. FMFM 11-17. 16 November 1992.
- FM 3-3-1. *Nuclear Contamination Avoidance*. FMFM 11-18. This manual defines and clarifies the entire process of nuclear contamination avoidance. It details the NBC Warning and Reporting System; how to locate and identify nuclear contamination, and how to operate in and around nuclear contamination. This manual is designed and intended to be an easy-to-read, step-by-step manual depicting the manual method of calculating nuclear contamination avoidance procedures for chemical officers and NCOs at brigade level and higher organizations. 9 September 1994.
- FM 3-4. *NBC Protection*. FMFM 11-9. 29 May 1992.
- FM 3-4-1. *Fixed Site Protection*. 16 August 89.
- FM 3-5. *NBC Decontamination*. FMFM 11-10. November 1993.
- FM 3-6. *Field Behavior of NBC Agents (Including Smoke and Incendiaries)*. November 1986
- FM 3-6. *Technical Aspects of Biological Warfare Agents*. (Draft).
- FM 3-7. *NBC Field Handbook*. This manual is a guide to help the chemical soldier at battalion level and below in NBC defense. It details the NBC warning and reporting system, how to locate, identify, and operate in and around NBC contamination. This manual is designed to be an easy-to-read, step-by-step manual depicting the manual method of calculating NBC defense procedures useful for the field soldier. 29 September 1994.
- FM 3-9. *Potential Military Chemical/Biological Agents and Compounds*. 12 December 1990.
- FM 3-11. *Flame Field Expedients*. 19 September 1990.
- FM 3-18. *Special NBC Reconnaissance (LB Team)*. 7 May 1993.
- FM 3-19. *NBC Reconnaissance*. November 1993.

- FM 3-50. *Smoke Operations*. 4 December 1990.
- FM 3-100. *NBC Defense, Chemical Warfare, Smoke, and Flame Operations*. FMFM 11-2. 23 May 1991.
- FM 3-101. *Chemical Staffs and Units*. 19 November 1993.
- FM 3-101-1. *Smoke Squad/Platoon Operations*.
- FM 3-101-2. *NBC Reconnaissance Platoons and Squads*.
- FM 8-9. *NATO Handbook on the Medical Aspects of NBC Defensive Operations*. This document is also published as NATO AmedP-6. This handbook is a guide for medical officers on the medical aspects of NBC operations. The handbook is intended as a compilation of reference material and as a source of information for training. In addition, it provides the basic philosophy for the development of concepts of operations and in the management, including evacuation and treatment, of NBC casualties as well as conventional battle casualties in a NBC environment. The handbook is in three parts, Part I-Nuclear, Part II-Biological, and Part III-Chemical. 1996.
- FM 8-10. *Health Service Support in a Theater of Operations*. 1 March 1991.
- FM 8-10-4. *Medical Platoon Leaders Handbook: Tactics, Techniques, and Procedures*. 16 November 1990.
- FM 8-10-6. *Medical Evacuation in a Theater of Operations: Tactics, Techniques, and Procedures*. 31 October 1990.
- FM 8-10-7. *Health Service Support in a Nuclear, Biological, and Chemical Environment*. April 1993 with change 1 dated Nov 96. This manual provides doctrine and tactics, techniques, and procedures for medical units and personnel operating in a nuclear, biological, and chemical (NBC) environment. This manual is intended for all echelons of health service support (HSS). It discusses the operational aspects of the following HSS activities: Medical treatment, medical evacuation, health service logistics, combat stress control, and preventive medicine, veterinary, dental, and medical laboratory services.
- FM 8-10-8. *Medical Intelligence in a Theater of Operations*. 7 July 1989.
- FM 8-10-17. *Preventive Medicine Services*. (Draft).
- FM 8-27. *Veterinary Service*. 30 September 1983.
- FM 8-30. *Veterinary Food Inspection Specialist*. 12 August 1986.
- FM 8-33. *Control of Communicable Diseases in Man* (15th Edition).
- FM 8-42. *Medical Operations in a Low Intensity Conflict*. 4 Dec 1990.
- FM 8-50. *Prevention and Medical Management of Laser Injuries*. 8 August 1990. This field manual provides basic preventive, protective, and diagnostic information on laser injuries. The treatment procedures described herein are for use by combat medics, battalion aid station personnel, and other medical treatment facilities without an Ophthalmologist. Also, an evaluation matrix is provided for use by combat lifesavers and combat medics.
- FM 8-51. *Combat Stress*.
- FM 8-55. *Planning for Health Service Support*. 15 February 1985.

- FM 8-230. *Medical Specialist*. 24 August 1984.
- FM 8-250. *Preventive Medicine Specialist*. 27 January 1986 (Change 1, September 1986).
- FM 8-285. *Treatment of Chemical Agent Casualties and Conventional Military Chemical injuries*. NAVMED P-5041/AFM 160-11. 28 February 1990.
- FM 10-52. *Water Supply in Theaters of Operations*. 11 July 1990.
- FM 21-10. *Field Hygiene and Sanitation*. 22 November 1988.
- FM 21-10-1. *Unit Field Sanitation Team*. 11 October 1989.
- FM 21-11. *First Aid for Soldiers*. 27 October 1988 (Change 1, August 1989; Change 2, FM 100-5. *Operations*. June 1993).
- FM 24-24. *Signal Data References: Signal Equipment*, 29 December 1994
- FM 31-71. *Northern Operations*. 21 June 1971.
- FM 90-3. *Desert Operations (How to Fight)*. FMFM 7-27. 19 August 1977.
- FM 90-5. *Jungle Operations (How to Fight)*. 16 August 1982.
- FM 90-6. *Mountain Operations*. 30 June 1980.
- FM 90-10. *Military Operations on Urbanized Terrain (MOUT) (How to Fight)*. 15 August 1979.
- FM 90-10-1. *An Infantryman's Guide to Urban Combat (How to Fight)*. 30 September 1982.
- FM 101-5. *Staff Organization and Operations*. May 1984.
- FM 101-15. *Risk Management*.
- FM 101-31-1. *Staff Officers' Field Manual: Nuclear Weapons Employment Doctrine and Procedures*. January 1986.
- Franz, D. R., P. B. Jahrling, A. M. Friedlander, D. J. McClain, D.L. Hoover, W. R. Bryne, J. A. Pavlin, G. W. Christopher, and E. M. Eitzen. 1997. Clinical recognition and management of patients exposed to biological warfare agents. *Journal of the American Medical Association*. 278(5): 399-411.
- Guide to Medical Considerations in NBC Battlefield Operations* (1st Draft).
- IAEA's *Summary report on the post-accident review meeting on the Chernobyl accident*. International Atomic Energy Agency, Vienna and Lanham, MD. 1986.
- Institute of Electrical and Electronics Engineers (IEEE) C95.1-1991, April 27, 1992, *IEEE Standard for Safety Levels with Respect to Human Exposure to Radiofrequency Electromagnetic Fields, 3 kHz to 300 GHz*.
- International Air Transportation Association-Dangerous Goods Regulations.
- International Non-ionizing Radiation Protection Committee of the International Radiation Protection Association, Health Physics, Vol. 58, No. 1 (January), pp. 113-122, "Interim Guidelines on Limits of Exposure to 50/60 Hz Electric and Magnetic Fields".

- International Task Force. Final Report 25: Hazard from Industrial Chemicals. Reconnaissance of Industrial Hazards: Chemical, Biological, Radiological- Tactic, Techniques, and Procedures.
- Joint Publication 3-11. *Joint Doctrine for Nuclear, Biological, and Chemical Defense Operations*. 10 July 1995.
- Joint Publication 3-11. *Joint Doctrine for Nuclear, Biological, and Chemical Defense Operations*. 1998 (Draft).
- Joint Publication 3-12.2 (Draft).
- Klenke, W. *Medical Implications of Lasers on the Modern Battlefield*, 1990.
- Leclercq, J. *The Nuclear Age*. Hachette, Poitiers, France. 1986.
- Letterman Army Institute of Research, Issues in the Development of the AIDMAN SCREENER, Laboratory Note No. 90-81.
- Letterman Army Institute of Research, Psychological Effects of Lasers on the Battlefield: Issues and Ideas, Institute Report No. 246.
- Manual of NBC Defense Training on Land*. UK? (AC No 71328/AP 3395, 2nd Edition/BR 8456.) Pamphlet No 6. A NBC Guide for Medical Personnel.
- Memorandum, NATO, MAS.USA/151.97, 12 November 1997, subject: STANAG MED (EDITION 2) - EVALUATION AND CONTROL OF PERSONNEL EXPOSURE TO RADIO FREQUENCY FIELDS - 3 KHz to 300 GHz.
- Memorandum, OTSG, SGPS-PSP, 11 April 1994, subject: Vision and Ocular Assessments of Personnel in Laser and Radiofrequency Radiation Environments.
- Memorandum, OTSG, SGPS-PSP, 13 January 1994, subject: The Sub-Radiofrequency Spectrum (Static to 3 kHz Band).
- Memorandum, OTSG, SGPS-PSP, 30 October 1991, subject: Microwave Oven Control Program
- Memorandum, OTSG, SGPS-PSP, April 1994, subject: Implementation of New Medical Surveillance System.
- National Council on Radiation Protection and Measurements, NCRP 94: *Exposure of the Population in the United States and Canada from Natural Background Radiation*. Bethesda, MD.
- National Council on Radiation Protection and Measurements, NCRP 65: *Management of Persons Accidentally Contaminated with Radionuclides*. Bethesda, MD. May 1989.
- National Council on Radiation Protection and Measurements, NCRP 97: *Measurement of radon and radon daughters in air*. Bethesda, MD.
- National Council on Radiation Protection and Measurements, NCRP 86: *Biological Effects and Exposure Criteria for Radiofrequency Electromagnetic Fields*. Bethesda, MD.
- National Research Council (Institute of Medicine), *Chemical and Biological Terrorism: Research and Development to Improve Civilian Medical Response*, National Academy Press, Washington DC, 1999.

- National Research Council, *Health Risks of Radon and Other Internally Deposited Alpha-Emitters* - BEIR IV, National Academy Press, Washington DC, 1988.
- NATO AMedP-6. (also FM 8-9) *Handbook on Medical Aspects of NBC Defensive Operations*.
- NATO AMedP-7. (also STANAG 2873) *Handbook on the Concept of Medical Support in NBC Environments*.
- NATO AmedP-8. *Medical Planning Guide of NBC Battle Casualties*, Volume I (Nuclear), Volume II (Biological), and Volume III (Chemical). (Draft)
- NATO Handbook. *Emergency War Surgery*. 1988. Available from: Superintendent of Documents, U.S. Government Printing Office, Washington, DC 20402.
- NATO STANAG 2002 -Warning Signs for the Marking of Contaminated or Dangerous Land Areas, Complete Equipment's, Supplies and Stores.
- NATO STANAG 2083 -Commanders Guide on Nuclear Radiation Exposure of Groups.
- NATO STANAG 2103 -Reporting Nuclear Detonations. Biological and Chemical Attacks, and Predicting the Warning of Associated Hazards and Hazard Areas (Allied Tactical Publication 45 (A)).
- NATO STANAG 2104, Friendly Nuclear Strike Warning.
- NATO STANAG 2112, Radiological Survey.
- NATO STANAG 2150 -Standards of Proficiency for NBC Defense.
- NATO STANAG 2352 -NBC Defense Equipment Operational Guidelines.
- NATO STANAG 2398, Friendly Chemical Attack Warning.
- NATO STANAG 2423, Dosimetry and Dosimerty Readings.
- NATO STANAG 2866, Medical Effects of Ionizing Radiation. 16 December 1988.
- NATO STANAG 2873, *Medical Support Operations in an NBC Environment*. Out of date and to be replaced with probably FM 10-8-7.
- NATO STANAG 2879, Principles of Medical Policy in the Management of a Mass Casualty Situation.
- NATO STANAG 2954, Training of Medical Personnel for NBC Operations.
- NAVFAC P-467; AFR 355-7. 12 December 1990.
- NAVMED P-5038. 31 May 1991.
- Nuclear Regulatory Committee, Reg Guide 8.21
- Nuclear Regulatory Committee, Reg Guide 8.23
- OPNAVINST 4630.9C; MCO P-4630-9A. 1 December 1975 (Change 1, May 1979).
- Reconnaissance of Industrial Hazards: Chemical, Biological, Radiological- Tactics, Techniques, and Procedures
- Shleien, B., 1983. *Emergency Preparedness and Response*, FDA.

- Shleien, B., Ed., 1992. *The Health Physics and Radiological Health Handbook*, Revised Edition, Scinta Inc., Silver Spring, MD.
- Shleien, B., L.A. Slaback, and B.K. Birky Eds. 1998. *Handbook of Health Physics and Radiological Health*, Third Edition, Williams and Wilkins, Baltimore, MD.
- STP 21-1-SMCT, Soldier's Manual of Common Tasks: Skill Level 1
- Sublette, Carey, *Nuclear Weapons Frequently Asked Questions*, Version 2.1, www.envirolink.org/issues/nuketesting/hew, May 16, 1997.
- TB 9-1300-278. Guidelines for Safe Response to Handling, Storage, and Transportation Accidents Involving Army Tank Munitions which Contain Depleted Uranium, 20 November 1987.
- TB MED 524. *Control of Hazards to Health from Laser Radiation*.
- TB MED 577. *Sanitary Control and Surveillance of Field Water Supplies*.
- TC 24-24. Signal Data References: Communications-Electronics Equipment, 3 October 1988 29 December 1994
- TC 3-10. Commander's Tactical NBC Handbook. Training circular 3-10 provides Commanders of battalions and brigades with the tactics, techniques and procedures to train and operate under nuclear, biological, and chemical (NBC) conditions. The three key issues are: What requirements NBC warfare places on you and your unit (Chapters 1, 2, 5 and 6), How your leadership improves unit performance under NBC conditions (Chapters 1, 3 and 4), and How you use all of your chemical assets (Chapters 7 and 8).
- TC 3-15. Nuclear Accident and Incident Response and Assistance (NAIRA). This training circular (TC) provides techniques, procedures, and guidance for nuclear accident and incident response and assistance during peacetime. It also provides technical guidance which can be used during both peacetime and wartime. TC 3-15 is intended for use by commanders both in and outside the continental United States (CONUS and OCONUS), by staff and soldiers whose units have custody of nuclear weapons and by US Army Depot personnel who respond to a nuclear accident or incident. Wartime NAIRA doctrine and procedures are fully discussed in FM 100-50. 27 December 1988.
- TC 8-13. Deployable Medical Systems Tactics, Techniques, and Procedures. 7 December 1990.
- Textbook of Military Medicine, Part III, Volume 2, Chapter 15, Nonionizing Radiation, 1993.
- TM 3-4240-264-12. Operator's and Organizational Maintenance Manual Shelter System, Collective Protection, Chemical-Biological: Inflatable, Trailer-Transported, M51. 29 August 1975 (Change 1, September 1976; Change 2, September 1977; Change 3, October 1979; Change, September 1981; Change 5, June 1990).
- TM 3-4240-288-12&P. Operator's and Unit Maintenance Manual Including Repair Parts and Special Tools List for Collective Protection Equipment NBC, Simplified, M20. NAVFACP-475. 20 August 1987.
- TM 8-215. Nuclear Handbook for Medical Service Personnel. Superseded by FM 8-10-17.
- TM 11-665-214-10. Technical Manual for the IM9E/PD, IM-93 and IM-147/PD.
- TM 11-665-236-12,-40. Technical Manuals for the PDR-75.

USACHPPM Medical Issues Information Paper No. IP 31-017, "Biological Agents as Potable Water Threats". 1998.

USACHPPM's Radiofrequency Radiation and Ultrasound Course Manual, April 1997.

USACHPPM's TG 211. *Radiobioassay Collection, Labeling, and Shipping Requirements*. TG 211 provides specimen collection, labeling, and shipping instructions for shipments to CHPPM.

USACHPPM's TG 218. *Detailed and General Facts About Chemical Agents*. The facts sheets contained in this Technical Guide are intended to provide summary information on 24 chemical warfare materials related to Chemical Stockpile and Non-Stockpile activities. In essence, they are a brief abstract of data contained in Material Safety Data Sheets and other technical references relevant to these substances.

USACHPPM's TG 236, 238, and 239. Radiological Health Risk Planning and Projection (Draft). These tech guides will provide methodology to determine the health risk from radiation exposure to deployed troops.

USAMRICD's *Field Management of Chemical Casualties*. This handbook provides concise supplemental reading material for attendees at the Field Management of Chemical and Biological Casualties. It includes the effects of chemical and biological agents and decontamination.

USAMRICD's *Management of Chemical Warfare Agent Casualties, A Handbook for Emergency Medical Services*. This handbook is a guide or reference for Emergency Medical Services (EMS) personnel in the management of casualties from military chemical warfare agents. It is not intended to be a definitive text on hospital or long-term care of such casualties. However, a brief description of such care for casualties from each type of agent is included.

USAMRICD's *Medical Management of Chemical Casualties*. The purpose of this handbook is to provide concise supplemental reading material for attendees at the Medical Management of Chemical and Biological Casualties. It includes the effects of chemical agents and the necessary clinical procedures.

USAMRICD's, *Medical Management of Chemical Casualties, NCO Handbook*, Sep 94.

USAMRIID's *Medical Management of Biological Casualties*. The purpose of this handbook is to provide concise supplemental reading material for attendees at the Medical Management of Chemical and Biological Casualties. It includes the effects of biological agents and the necessary clinical procedures. 3rd Edition, July 1998. This handbook is scheduled to become FM 8-284.

USAMRMC's *Medical Products for Supporting Military Readiness, Vaccines & Drugs (GO BOOK)*. December 1995.

Index

- 2 Pam Chloride, 5-29
 2,4,5-T, 5-53
 2,4-D, 5-53
 3-quinuclidinyl benzilate, 5-20, 5-21, 5-22, 5-23, 5-24, 5-25, 5-26, 5-27, 5-39, 5-40
 ABC-M11, 7-26
 Abrin, 4-21
 Absorbed dose, 2-25, 3-30
 Absorption, 2-22, 3-21, 3-41, 3-42, 3-43, 3-44, 3-46, 4-37, 5-9, 5-28, 5-30, 5-33, 5-36, 5-53, 5-54, 6-11, 6-13, 6-22, 6-25, 7-26
 AC, see Hydrogen cyanide
 ACADA, 7-2, 7-15, 7-20
 ACALA, 3-3, 3-9, 3-11, 3-12, 3-17, 3-18, 3-43, 7-6, 7-10, 8-2, 8-9
 ACAMS, 7-2, 7-21
 ACE Directive, 1-7, 1-12, 3-2, 3-21, 3-22, 3-24, 3-25, 5-1, 5-45
 ACP-1, 6-8, 6-9
 Acrlonitrile, 5-7
 Acuity, 1-3, 6-1, 6-2, 6-11, 6-14, 6-16, 6-17, 6-26
 Adamsite, 5-20, 5-21, 5-22, 5-23, 5-24, 5-25, 5-26, 5-27, 5-42, 5-43
 ADM-300, 7-1, 7-11
 Aerosol, 3-41, 4-2, 4-5, 4-6, 4-11, 4-12, 4-22, 4-23, 4-24, 4-25, 4-26, 4-28, 4-30, 4-31, 4-32, 4-33, 4-34, 4-35, 4-36, 4-37, 4-38, 4-39, 5-18, 5-19, 5-28, 5-41, 7-14, 7-18, 7-29, 7-30
 AFIP, 8-2, 8-10
 Aflatoxin, 4-7, 4-21, 4-29
 AFMIC, 1-5, 1-8, 3-3, 3-6, 3-7, 4-2, 4-20, 8-1, 8-3, 8-4
 AFOC, 8-1, 8-7
 AFRR1, 1-7, 2-9, 2-28, 2-32, 2-34, 3-48, 8-2, 8-8
 Agglutination, 4-30
 Aidman, 6-1, 6-2, 6-3, 6-4, 6-10, 6-14, 6-16, 6-17, 6-18
 AIM-1, 6-8, 6-9
 Alimentary toxic aleukia, 4-38
 Alpha particles, 2-19, 3-13, 3-14, 3-23, 3-28, 3-29, 3-30, 3-31, 3-32, 3-39, 3-40, 3-41, 3-43, 3-44, 3-45, 3-46, 3-47, 5-49, 7-6, 7-7, 7-9, 7-10, 7-11, 7-30, 8-8
 Alphavirus, 4-20, 4-21
 AMC, 1-4, 8-1, 8-5, 8-6, 8-8
 AMEDD, 1-4, 1-7, 2-18, 3-14, 3-15, 3-35, 3-38, 8-1, 8-5
 AMedP-6, 2-32, 2-34
 AMedP-7, 5-15
 AMedP-8, 1-11, 2-6, 4-27
 Americium, 3-7, 3-13, 3-43
 AML, see TAML
 Ammonia, 5-7, 5-15, 5-43, 5-44, 7-17
 Amsler Grid, 6-2, 6-14, 6-16, 6-17
 AN/ASQ-170, 6-8, 6-9
 AN/GVS-5, 6-8, 6-9
 AN/PAQ-1, 6-8, 6-9
 AN/PAQ-3, 6-8, 6-9
 AN/PDR-75, 7-4, 7-5, 7-6
 AN/PDR-77, 1-16, 3-13, 7-1, 7-6, 7-7, 7-8, 7-10
 AN/PEQ-1, 6-8, 6-9
 AN/PVS-6, 6-8, 6-9
 AN/TVQ-2, 6-8, 6-9
 AN/UDR-13, 7-1, 7-11
 AN/VDR-2, 7-1, 7-6, 7-7, 7-8, 7-9
 AN/VVG-1, 6-8, 6-9
 AN/VVG-2, 6-6, 6-8, 6-9
 AN/VVG-3, 6-8, 6-9
 Analgesic, 5-22, 6-13, 6-15
 Anatoxin A, 4-7, 4-21
 Animal, 2-5, 4-5, 4-15, 4-17, 4-18, 4-19, 4-28, 4-31, 4-32, 4-34, 4-35, 4-36, 4-38, 4-39
 Anorexia, 2-27, 2-33, 4-32, 4-35, 5-24
 ANSI, 3-29, 6-5, 6-6, 6-7, 6-25
 Antennas, 6-24
 Anthrax, 1-9, 4-5, 4-7, 4-9, 4-20, 4-22, 4-27, 4-28, 4-29, 4-30, 4-31, 7-11
 Antibiotic, 2-28, 2-32, 4-2, 4-11, 4-13, 4-15, 4-16, 4-27, 4-31, 4-32, 5-22, 6-13, 6-15
 Antibody, 4-17, 4-31, 4-32, 7-12, 7-13
 Anticholinergic, 5-22, 5-38
 Anticholinesterase, 5-22
 Anticonvulsants, 5-29, 5-32
 Antiemetics, 2-29
 Antigen, 4-17, 4-31, 7-11, 7-12, 7-13
 Antimicrobial, 4-17, 4-22, 4-23, 4-24, 4-25
 Antisera, 4-22, 4-23, 4-24, 4-25
 Antitoxin, 4-27, 4-32
 Antiviral, 4-16, 4-27
 Anuria, 4-36
 Anxiety, 5-17, 5-25, 5-40, 6-23, 6-26
 AOC, 8-1, 8-7
 Aponia, 5-24
 Areflexia, 5-25
 Arenavirus, 4-20, 4-21
 Argentine hemorrhagic fever, 4-20, 4-29
 Arsenic, 5-9, 5-10, 5-12, 5-25, 5-35
 Arsenicals, 5-8, 5-9, 5-12, 5-33
 ARTEP, 1-7
 Arthralgia, 4-29, 4-32
 Asthenia, 4-39
 Ataxia, 5-25
 Atmospheric, 2-20, 3-5, 3-21, 4-6, 4-16, 5-19, 5-51
 Atropine, 4-1, 4-30, 5-18, 5-22, 5-29, 5-32, 7-23, 7-24
 ATSDR, 5-43, 8-11

- AVENGER, 6-8, 6-9
 BA, see Biological Agent
Bacillus anthracis, see Anthrax
 Bacteremia, 4-39
 Bacteria, 4-1, 4-16, 4-17, 4-20, 4-22, 4-32, 7-11, 7-12
 Barrier nursing, 4-12, 4-14, 4-27
 Battalion, 3-3, 3-37, 5-14, 7-23, 7-27, 7-32
 Battle Dress Uniform, 1-15, 1-16
 Battledress Overgarment, 7-30
 BD, see Biological Defense
 BDO, see Battledress Overgarment
 BDU, see Battle Dress Uniform
 Beryllium, 3-13, 7-10
 Beta particles, 2-19, 2-20, 3-9, 3-13, 3-14, 3-22, 3-23, 3-28, 3-29, 3-31, 3-32, 3-35, 3-38, 3-39, 3-40, 3-41, 3-42, 3-43, 3-44, 3-45, 3-46, 7-6, 7-7, 7-8, 7-9, 7-11, 8-8
 BIDS, 1-4, 1-10, 4-2, 4-4, 4-17, 4-19, 7-1, 7-13
 Bioassay, 3-1, 3-15, 3-18, 3-19, 3-38, 3-46, 7-1, 7-11, 7-12
 Biological Agent, 1-3, 1-8, 1-9, 1-10, 3-3, 4-1, 4-2, 4-5, 4-6, 4-7, 4-8, 4-9, 4-10, 4-11, 4-12, 4-13, 4-14, 4-15, 4-16, 4-17, 4-18, 4-19, 4-20, 4-27, 4-28, 4-30, 4-31, 5-9, 7-12, 7-13, 7-25, 7-29, 7-30, 7-32
 Biological attack, 1-4, 4-2, 4-9, 4-12, 4-15, 4-34, 7-13
 Biological Defense, 4-15, 4-27, 8-3
 Biological Integrated Detection System, see BIDS
 Biological Warfare, 1-2, 1-9, 2-5, 4-1, 4-2, 4-3, 4-4, 4-5, 4-6, 4-7, 4-9, 4-10, 4-11, 4-12, 4-13, 4-14, 4-15, 4-17, 4-18, 4-19, 4-20, 4-21, 4-27, 4-29, 4-31, 4-32, 4-33, 4-34, 4-35, 4-36, 4-38, 4-39, 7-12, 7-29, 8-10
 Biological weapon, 1-2, 1-3, 1-5, 1-6, 4-1, 4-2, 4-15, 4-7, 4-16, 4-31, 4-37, 5-15, 5-18
 Blast, 1-11, 2-2, 2-6, 2-17, 2-18, 2-19, 2-20, 2-21, 2-25
 Blister agent, 1-2, 5-1, 5-7, 5-10, 5-11, 5-15, 5-20, 5-21, 5-32, 5-33, 5-34, 7-16, 7-17, 7-18, 7-19, 7-20, 7-21, 7-23, 7-29
 Blood agent, 5-1, 5-20, 5-21, 5-36, 7-18, 7-23, 7-29
 BLPS, 6-2, 6-18, 6-19, 6-21
 Bolivian hemorrhagic fever, 4-20, 4-29
 Bone marrow, 2-24, 2-25, 2-29, 2-35, 3-45, 4-30, 4-38, 5-22, 5-25, 5-34
 Botulinum toxin, 4-7, 4-21, 4-24, 4-27, 4-28, 4-29, 4-30, 4-31, 4-32, 7-11
 Botulism, 4-21, 4-31
 Bradycardia, 5-22
 Bromine, 5-7
 Bromoacetone, 5-41
 Bromobenzylcyanide, 5-20, 5-21, 5-22, 5-23, 5-24, 5-25, 5-26, 5-27, 5-41
 Bronchitis, 5-24
Brucella, see Brucellosis
 Brucellosis, 4-7, 4-20, 4-22, 4-27, 4-28, 4-29, 4-30, 4-32, 7-11
 Bubo, 4-34
 Bubonic, 4-5, 4-28, 4-34
 Buddy-aid, 1-9, 7-24
 Bunyavirus, 4-20
Burkholderia mallei, see Glanders
 Burns, 2-1, 2-2, 2-3, 2-6, 2-7, 2-11, 2-17, 2-22, 2-27, 2-28, 2-33, 5-35, 5-42, 5-50, 5-51, 5-52, 6-3, 6-10, 6-12, 6-13, 6-14, 6-18, 6-22, 6-26
 Burst, 2-6, 2-12, 2-16, 2-17, 2-18, 2-19, 2-20, 2-21, 3-4, 5-5, 5-17, 7-5
 BW, see Biological Warfare
 BZ, see 3-quinuclidinyl benzilate
 CA, see Bromobenzylcyanide
 Cacodylic acid, 5-53
 CAD, 7-1, 7-15, 7-18
 Calcium, 3-8, 3-16, 3-42, 3-43, 3-45, 7-23, 7-27
 Calcium hypochlorite, 7-23, 7-27
 CAM, see Chemical Agent Monitor
 CANA, 7-2, 7-24
 Cannabinol, 5-40
 CAPDS, 7-2, 7-22
 Carbamate anticholinesterase, 5-29
 Carbon, 3-8, 3-43, 5-17, 5-38, 5-45, 5-53, 5-54, 5-55, 6-8, 6-18, 7-30, 7-31
 Carbon monoxide, 5-16, 5-51, 5-52, 5-53, 6-8
 Casualties, 1-1, 1-3, 1-7, 1-9, 1-10, 1-11, 1-13, 1-14, 1-17, 1-18, 2-1, 2-2, 2-5, 2-6, 2-7, 2-9, 2-11, 2-12, 2-18, 2-21, 2-26, 2-27, 2-28, 2-29, 3-32, 3-40, 4-2, 4-5, 4-8, 4-9, 4-10, 4-11, 4-12, 4-13, 4-14, 4-15, 4-19, 4-27, 4-31, 5-2, 5-7, 5-9, 5-16, 5-17, 5-18, 5-20, 5-28, 5-32, 5-34, 5-35, 5-36, 5-37, 5-38, 5-39, 5-41, 5-43, 6-3, 7-23, 7-32, 8-10
 CBIRF, 4-17, 8-2, 8-7
 CBPS, 7-3, 7-32
 CDC, 1-10, 4-20, 4-32, 8-2, 8-10, 8-11
 Central Nervous System, 2-26, 4-34, 5-25, 5-29, 5-30, 5-32, 5-36, 5-37, 5-38
 Cerium, 3-16
 Cesium, 3-4, 3-5, 3-6, 3-7, 3-8, 3-13, 3-15, 3-16, 3-43
 CFR, 3-30, 3-48, 5-19
 CG, see Phosgene
 Chain of custody, 1-4, 1-10, 4-19
 Charcoal filters, 5-36
 Chelating, 3-42, 3-48
 Chemical Agent Monitor, 1-15, 1-16, 3-13, 3-44, 5-28, 7-1, 7-10, 7-14, 7-17, 7-18, 7-20, 7-22
 Chemical agent, 1-2, 1-3, 1-8, 1-10, 1-12, 1-15, 4-8, 4-11, 4-13, 4-16, 4-17, 4-29, 4-35, 5-1, 5-2, 5-3, 5-8, 5-9, 5-10, 5-11, 5-15, 5-16, 5-17, 5-18, 5-19, 5-20, 5-21, 5-22, 5-23, 5-24, 5-25, 5-26, 5-27, 5-28, 5-37, 5-49, 6-14, 7-1, 7-2, 7-14, 7-15, 7-16, 7-17, 7-18, 7-19, 7-20, 7-21, 7-22, 7-23, 7-24, 7-25, 7-27, 7-29, 7-30, 7-31, 7-32
 Chemical hazard, 1-3, 1-13, 3-42, 5-3, 5-47

- Chemical School, 8-1, 8-4, 8-5
 Chemical warfare, 1-2, 1-10, 1-15, 2-5, 4-12, 5-13, 5-15, 5-18, 5-46, 5-48, 7-17, 7-18, 7-20, 7-21, 7-22, 8-10
 Chemical weapons, 1-2, 1-3, 1-5, 1-6, 1-7, 1-14, 5-3, 5-4
 Chemoprophylaxis, 1-11, 4-13, 4-35
 Chikungunya Fever, 4-20, 4-25, 4-29
 Chlamydia, 4-1, 4-17, 4-20, 4-23
 Chlorination, 4-6, 5-10, 5-13
 Chlorine, 1-6, 1-15, 4-7, 4-13, 5-4, 5-7, 5-10, 5-13, 5-26, 5-37, 5-44, 5-52
 Chloroacetophenone, 1-2, 5-20, 5-21, 5-22, 5-23, 5-24, 5-25, 5-26, 5-27, 5-41, 5-42
 Chloropicrin, 5-20, 5-21, 5-26, 5-27, 5-37
 Chlorosulphonic acid, 5-50, 5-51
 Choking agent, 5-11, 5-16
 Cholera, 4-7, 4-20, 4-22, 4-27, 4-28, 4-29, 4-32, 4-33
 Choroid, 6-11, 6-13
 CHPPM, see USACHPPM
 CIA, 1-5
 CINC, 4-13, 4-14, 7-24, 7-25
 CK, see Cyanogen chloride
 Class 1, 6-7
 Class 2, 6-7
 Class 3, 6-7
 Class 4, 6-7
 Climate, 1-8, 5-7
 Clostridium, 4-7, 4-21, 4-24, 4-31, 4-33
Clostridium botulinum, see Botulism
Clostridium perfringens, 4-7, 4-21, 4-24
Clostridium tetani, see Tetanus
 CN, see Chloroacetophenone
 CNS, 2-28, 2-33, 2-36, 5-20, 5-26, 5-27, 5-31, 5-38, 5-39, 5-40, 5-53
 Cobalt, 3-4, 3-6, 3-7, 3-8, 3-13, 3-44, 5-37
 Coccidioides immitis, see Coccidioidomycosis
 Coccidioidomycosis, 4-21
 Collective protection, 1-11, 1-12, 1-13, 4-10, 4-11, 4-12, 7-3, 7-20, 7-31, 7-32
 Combat stress reaction, 5-18
 Combat zone, 4-13, 4-14
 Communicable, 4-6, 4-13, 4-34
 Communication, 2-8, 2-13, 2-18, 3-33, 3-35, 6-2, 6-22, 6-24, 6-25, 7-20, 7-22, 7-29, 8-2, 8-7
 Conjunctival, 4-33, 4-34, 4-36, 4-38, 5-30, 6-15
 Contamination, 1-5, 1-9, 1-10, 1-11, 1-12, 1-14, 1-15, 1-17, 2-6, 2-8, 2-13, 2-14, 2-15, 2-20, 2-21, 2-28, 2-34, 3-1, 3-3, 3-5, 3-7, 3-8, 3-14, 3-15, 3-18, 3-19, 3-20, 3-21, 3-23, 3-24, 3-25, 3-26, 3-28, 3-29, 3-30, 3-32, 3-33, 3-34, 3-38, 3-42, 3-43, 3-46, 4-6, 4-9, 4-10, 4-12, 4-13, 4-14, 4-32, 5-1, 5-3, 5-8, 5-9, 5-10, 5-11, 5-13, 5-15, 5-17, 5-28, 5-33, 5-39, 5-42, 5-48, 5-49, 5-50, 5-54, 7-4, 7-10, 7-16, 7-17, 7-18, 7-30, 7-32
 Continuous wave, 6-3, 6-5, 6-7, 6-8
 CONUS, 4-9, 4-19, 4-20, 8-8, 8-9
 Cornea, 2-23, 5-35, 6-3, 6-10, 6-12, 6-13, 6-14, 6-15, 6-26
 Corticosteroids, 5-22
Coxiella burnetii, see Q fever
 CP DEPMEDS, 7-3, 7-32
 CR, see Dibenzoxazepine
 Crimean-Congo hemorrhagic fever, 4-20, 4-25, 4-27, 4-28, 4-29, 4-33
 Crisis coordination center, 8-1, 8-6
 Cryptosporidiosis, 4-7, 4-21
 Cryptosporidium spp., see Cryptosporidiosis
 CS, see O-Chlorobenzylidene Malononitrile
 CSA, see Chlorosulphonic acid
 Cutaneous, 4-5, 4-31, 4-35, 4-39, 5-28
 CW, 4-17, 5-13, 5-15, CX, see Phosgene oxime
 Cyanide, 5-7, 5-11, 5-14, 5-20, 5-22, 5-36, 5-41
 Cyanogen chloride, 5-20, 5-21, 5-22, 5-23, 5-24, 5-25, 5-26, 5-27, 5-36, 5-37, 7-14, 7-15
 Cyanogen, 5-1, 5-10, 5-14, 5-20, 5-36, 5-37
 Cyanosis, 4-31, 4-34, 5-23
 Cycloplegics, 5-22
 DA, see Diphenylchlorarsine
 DA Form 4137, 4-19
 DAMP, 5-22
 Danger zones, 4-8
 Dazopride, 2-29
 Dazzle, 1-3, 6-15
 DC, see Diphenylcyanarsine
 Decay, 2-1, 2-14, 2-15, 2-19, 2-20, 3-5, 3-6, 3-7, 3-31, 3-39, 3-40, 3-43, 3-44, 3-45, 3-47, 4-6
 Decontaminable Litter, 7-3, 7-31
 Decontamination, 1-1, 1-4, 1-7, 1-9, 1-10, 1-11, 1-14, 1-15, 1-16, 1-17, 2-7, 2-29, 2-32, 3-4, 3-15, 3-18, 3-20, 3-21, 3-26, 3-28, 3-29, 3-32, 3-34, 3-48, 4-9, 4-10, 4-11, 4-13, 4-14, 4-17, 5-1, 5-2, 5-9, 5-10, 5-13, 5-14, 5-15, 5-17, 5-35, 5-42, 5-49, 5-51, 5-52, 7-2, 7-3, 7-17, 7-18, 7-23, 7-25, 7-26, 7-27, 7-28, 7-32, 8-7
 Defervescence, 4-37
 Delivery system, 4-5, 4-6
 Dengue fever, 4-21, 4-25, 4-27, 4-28, 4-29
 Department of State, 8-3, 8-11
 Depleted uranium, 3-2, 3-10, 3-12, 3-15, 3-19, 3-28, 3-29, 3-38, 3-46, 3-47, 3-48, 7-10, 8-8
 Deployment, 1-1, 1-3, 1-4, 1-7, 1-8, 1-10, 1-12, 5-2
 DEPMED, 7-32
 Dermal exposure, 4-6, 4-11, 4-13, 4-30
 Dermatitis, 5-23
 Detection, 1-3, 1-4, 1-5, 1-9, 1-11, 1-12, 2-7, 3-1, 3-3, 3-13, 3-18, 3-24, 3-25, 3-31, 3-32, 3-34, 3-35, 3-43, 4-2, 4-4, 4-16, 4-17, 5-9, 5-17, 5-28, 5-33, 5-36, 5-37, 5-39, 5-41, 5-42, 5-49, 5-50, 5-51, 5-52, 6-2, 6-22, 7-1, 7-2, 7-3, 7-7, 7-8, 7-11, 7-12, 7-13, 7-16, 7-18, 7-19, 7-21, 7-22, 8-3, 8-7, 8-9

- Detector, 1-10, 1-12, 1-15, 1-16, 3-13, 3-34, 3-46, 5-9, 5-16, 5-28, 5-33, 5-39, 7-1, 7-2, 7-4, 7-5, 7-7, 7-8, 7-10, 7-13, 7-14, 7-15, 7-16, 7-17, 7-18, 7-19, 7-20, 7-21, 7-22
- Detonation, 2-1, 2-2, 2-5, 2-6, 2-12, 2-13, 2-14, 2-15, 2-17, 2-18, 2-19, 2-20, 2-21, 2-22, 2-23, 2-25, 3-22, 3-39
- DEW, see Directed energy weapon
- DIA, 1-5,
- Diagnosis, 2-26, 2-27, 2-28, 2-29, 4-27, 4-29, 5-16, 5-18, 5-39, 6-1, 6-14, 6-15
- Diaphoresis, 4-31
- Diarrhea, 2-11, 2-25, 2-26, 2-27, 2-28, 2-29, 2-33, 4-2, 4-29, 4-30, 4-32, 4-35, 4-38, 4-39, 5-24, 5-29, 5-32, 5-34, 5-53
- Diathesis, 2-33, 4-34
- Diazepam, 5-22, 5-29, 5-32, 5-41, 7-24
- Dibenzoxazepine, 5-20, 5-21, 5-22, 5-23, 5-24, 5-25, 5-26, 5-27, 5-41
- Diphenylchlorarsine, 5-20, 5-21, 5-22, 5-23, 5-24, 5-25, 5-26, 5-27, 5-42
- Diphenylcyanarsine, 5-20, 5-21, 5-22, 5-23, 5-24, 5-25, 5-26, 5-27, 5-42
- Diphosgene, 5-20, 5-21, 5-26, 5-27, 5-37
- Diplopia, 4-31
- Diphtheria, 4-28
- Directed energy weapon, 6-3
- Director of Military Support, 8-2, 8-7
- Disease incidence, 4-2, 4-5, 4-9
- Disease pattern, 4-5
- Disposition, 2-2, 2-31, 2-34, 2-35, 3-18, 5-1, 5-9, 5-12, 5-49
- Dissemination, 1-5, 4-5, 4-6, 4-16, 4-22, 4-23, 4-24, 4-25, 5-2, 5-41
- Divergence, 6-1, 6-5, 6-6, 6-7, 6-10
- DKIE, 7-17
- D-Lysergic Acid Diethylamide, 5-20, 5-21, 5-22, 5-23, 5-24, 5-25, 5-26, 5-39, 5-40, 5-41
- DM, see Adamsite
- DNA probe, 4-17
- DNBI, 1-4, 1-9
- Dosimeter, 2-26, 2-27, 3-15, 3-31, 3-35, 3-36, 3-37, 7-1, 7-4, 7-5, 7-6, 7-11
- Dosimetry, 2-6, 2-26, 2-29, 2-35, 3-1, 3-15, 3-23, 3-35, 3-36, 3-37, 3-43, 8-2, 8-9
- Draeger tubes, 5-49
- Droplet, 4-1, 4-6, 4-8, 4-16, 4-30, 4-36, 4-37
- DS2, 5-15, 7-2, 7-26, 7-27
- DSWA, 8-5
- DT-236, 7-4, 7-5
- DTRA, 3-16, 3-17, 8-1, 8-5
- DU, see Depleted uranium
- Dysarthria, 4-32
- Dysphagia, 4-29, 4-30, 4-32, 5-53
- Dysphonia, 4-30, 4-32
- Dyspnea, 4-31, 4-34, 4-38, 5-24, 5-30, 5-37, 5-38, 5-43
- Eastern equine encephalitis, 4-21, 4-25, 4-28, 4-29
- Ebola, 4-21, 4-25, 4-27, 4-29
- Edema, 4-31, 4-36, 4-38, 5-22, 5-23, 5-24, 5-34, 5-35, 5-37, 5-38, 5-50, 5-51, 5-52, 6-11
- EEE, see Eastern equine encephalitis
- EHF, see Extremely High Frequencies
- EICC, 8-3, 8-11
- Electric field, 6-25
- Electromagnetic field, 6-22, 6-24
- Electromagnetic pulse, 2-5, 2-17, 2-18, 2-21
- Electromagnetic spectrum, 6-1, 6-5, 6-23
- Electron, 3-7, 3-8, 3-32, 3-35, 3-39, 3-40, 3-45, 7-12
- ELISA, see Enzyme Linked Immunosorbent Assay
- Emesis, 2-32, 4-30, 5-41, 5-53, 5-54
- EMP, see Electromagnetic pulse
- Encephalomyelitis, 4-7
- Endemic Typhus, 4-20, 4-28
- Endemic, 1-3, 1-4, 1-8, 2-10, 4-28, 8-6
- Enhanced radiation, 2-18
- Enterotoxin, 4-7, 4-21, 4-24, 4-27, 4-29, 4-32, 4-37, 4-38
- Enzyme Linked Immunosorbent Assay, 4-30, 7-1, 7-11, 7-12
- EPA, 3-48, 8-7
- Epidemiology, 1-2, 1-9
- Epididymo-orchitis, 4-32
- Epistaxis, 4-36
- Epizootic, 4-36
- Eructation, 5-24
- Erythema, 2-26, 2-28, 3-48, 5-23, 5-34, 5-35, 5-51, 6-15, 6-23, 6-25
- Etiologic agent, 4-17
- Evacuation, 1-1, 1-4, 1-9, 1-17, 2-6, 2-8, 2-9, 2-25, 2-34, 2-35, 3-19, 3-23, 3-25, 4-11, 4-14, 5-22, 5-38, 5-39, 5-46, 6-1, 6-3, 6-4, 6-14, 6-16
- Exotoxin, 4-38
- Extremely High Frequencies, 6-24
- Extremely Low Frequencies, 6-24
- Fallout, 2-1, 2-6, 2-7, 2-8, 2-9, 2-12, 2-13, 2-14, 2-17, 2-19, 2-20, 3-3, 3-32, 2-36, 3-41, 3-42, 3-43, 5-9, 5-10, 7-11, 7-29
- Fasciculations, 5-25
- FDA, 4-27, 4-33, 7-24, 7-25
- FEMA, 3-3, 8-2, 8-11
- Fever, 2-26, 2-33, 4-15, 4-25, 4-28, 4-29, 4-31, 4-33, 4-34, 4-35, 4-36, 4-37, 4-38, 4-39, 5-24, 5-25, 5-34
- Filovirus, 4-21, 4-27
- Filter, 1-15, 3-35, 4-5, 4-6, 4-11, 4-36, 5-10, 5-12, 5-48, 6-18, 7-28, 7-29, 7-30, 7-31, 7-32
- Filtration, 4-6, 4-12, 5-10
- Fission, 2-17, 2-18, 2-19, 2-20, 3-2, 3-5, 3-8, 3-16, 3-40, 3-42
- Flaccid, 4-29, 4-30, 4-37

- Flashblindness, 2-2, 2-22
 Flavivirus, 4-20, 4-21, 4-27
 Fleas, 4-6, 4-34
 Flocculation, 5-10
 Fluctuant, 4-34
 Fog oil, 5-50, 5-51
 Fomite, 4-37
 Food, 1-2, 1-9, 2-7, 2-15, 3-5, 3-6, 3-15, 3-42, 3-43, 3-44, 3-46, 4-5, 4-6, 4-9, 4-10, 4-12, 4-17, 4-18, 4-22, 4-23, 4-24, 4-30, 4-32, 4-33, 4-38, 5-1, 5-8, 5-9, 5-10, 5-11, 5-12, 5-34, 5-39, 6-22, 7-24
 FOX, 1-4, 1-10, 7-2, 7-19, 7-22
Francisella tularensis, see Tularemia
 Frequencies, 6-18, 6-22, 6-23, 6-24, 6-25
 Fulminant, 4-29, 4-32, 4-34, 4-39
 Fungi, 4-17, 4-38
 G3, 2-8
 G4, 2-8
 G5, 1-3
 G6, 2-8
 GA, see Tabun
 GaAIs, 6-8
 Gamma rays, 2-17, 2-19, 2-20, 3-8, 3-13, 3-14, 3-22, 3-23, 3-27, 3-30, 3-31, 3-32, 3-35, 3-36, 3-39, 3-40, 3-41, 3-42, 3-43, 3-44, 7-4, 7-5, 7-6, 7-7, 7-9, 7-11
 Gangrene, 4-33
 GAO, 8-2, 8-11
 Gastrointestinal, 2-23, 2-24, 2-25, 2-26, 2-29, 2-36, 3-21, 3-41, 3-44, 3-42, 4-33, 4-37, 4-39, 5-30, 5-34, 7-25
 GB, see Sarin
 GD, see Soman
 Geiger-Mueller Counter, 3-31, 3-32, 3-46
 Generator, 3-5, 3-9, 5-3, 6-23, 7-4, 7-13, 7-27, 7-32
 Genome, 4-17, 7-12
 GF, 5-20, 5-21, 5-22, 5-23, 5-24, 5-25, 5-26, 5-27
 Glanders, 4-7, 4-20, 4-27, 4-29, 4-34
 Glare, 6-11, 6-15
 Gloves, 1-11, 1-13, 1-14, 1-15, 3-6, 3-12, 3-14, 3-15, 3-18, 3-19, 4-11, 4-13, 4-14, 5-28, 5-33, 5-39, 7-25, 7-26, 7-32
 GO BOOK, 4-8, 4-12, 4-31
 Gram-negative, 4-32, 4-34, 4-38
 Gram-stain, 4-30
 H, see Sulfur Mustard
 Half-life, 3-16, 3-39, 3-42, 3-43, 3-44, 3-45
 HAMMER ACE, 8-2, 8-7
 Hantaan, 4-20, 4-25, 4-28
 HC, see Hexachloroethane smoke
 HD, see Sulfur Mustard
 Heat stress, 1-8, 4-10, 7-30
 Helicopter, 1-17, 2-8, 2-16, 7-27, 7-29, 7-31
 Hematopoietic, 2-23, 2-25, 2-36
 Hematuria, 4-33, 5-53
 Hemolysis, 4-33
 Hemorrhagic fever, 4-7, 4-20, 4-25, 4-27, 4-29, 4-30, 4-33, 4-36
 Hemorrhage/ing, 4-2, 4-33, 4-34, 4-38, 6-3, 6-11, 6-13, 6-14, 6-15
 Hepatitis A, 4-7, 4-21
 Herbicides, 5-1, 5-53
 Hexachloroethane smoke, 5-37, 5-50, 5-51
 HF, see High Frequencies
 High Frequencies, 6-24
 Histoplasma capsulatum, see Histoplasmosis
 Histoplasmosis, 4-7, 4-21, 4-23, 4-29
 HL, see Mustard/Lewisite Mixture
 HN, see Nitrogen Mustard
 HQDA, 8-1, 8-5, 8-9
 HSS, 4-10
 HT, see Mustard
 HTH, 7-27
 Hydrocarbon, 5-1, 5-52, 5-53
 Hydrogen chloride, 5-44
 Hydrogen cyanide, 5-14, 5-19, 5-20, 5-21, 5-22, 5-23, 5-24, 5-25, 5-26, 5-27, 5-36, 5-37, 5-44, 7-14, 7-15, Hydrogen sulfide, 5-7, 5-44
 Hygiene, 1-4, 1-12, 4-4, 4-10, 4-12, 4-13, 6-13
 Hyperemia, 5-30
 Hyperthermia, 2-26, 2-28
 Hypotension, 2-26, 2-27, 2-28, 2-29, 2-33, 4-29, 4-33, 4-35, 4-38, 5-22, 5-40
 Hypothermia, 2-28, 4-35
 Hypovolemia, 4-32
 Hypoxemia, 5-38
 Hypoxia, 5-38, 5-51
 IBADS, 4-4, 7-1, 7-12, 7-13
 ICAD, 7-1, 7-15, 7-18
 ICAM, 7-1, 7-14, 7-17
 ICRP, 3-48
 ICt50, 5-19
 Icterus, 4-36
 IFA, 4-30
 Ileus, 4-30, 4-31
 IM-143/PD, 7-4
 IM-147, 7-1, 7-4, 7-5
 IM-9, 7-4
 IM-93, 7-1, 7-4, 7-5
 IM-9E/PD, 7-1, 7-4, 7-5
 Immunity, 4-37
 Immunization, 4-4, 4-10, 4-12, 4-34, 4-35, 4-38
 Immunoassay, 4-17, 7-12, 7-13
 Immunofluorescence, 4-18
 Immunoglobulin, 4-17
 Immunoprophylaxis, 4-12
 Incapacitating agents, 5-16, 5-20, 5-38, 5-39
 Incendiary, 1-2, 5-52
 Incubation, 4-6, 4-13, 4-15, 4-16, 4-22, 4-23, 4-24, 4-25, 4-26, 4-28, 4-31, 4-32, 4-34, 4-35, 4-36, 4-37, 4-39
 IND, see Investigational New Drug

- Indoles, 5-40
 Industrial chemicals, 1-2, 5-43, 5-46, 7-19
 Infarction, 4-36
 Infectivity, 4-16, 4-22, 4-23, 4-24, 4-25, 4-26, 4-37
 Influenza, 4-21, 4-29
 Influenzavirus, 4-21
 Infrared, 3-12, 6-3, 6-5, 6-6, 6-9, 6-12, 6-15, 6-18, 7-19, 7-21, 7-22
 Ingestion, 2-20, 3-4, 3-12, 3-14, 3-28, 3-41, 3-44, 3-46, 3-47, 4-6, 4-28, 4-30, 4-35, 4-36, 4-39, 5-29, 5-30, 5-31, 5-34, 5-53, 5-54
 Inhalation, 2-20, 3-4, 3-5, 3-6, 3-12, 3-14, 3-15, 3-19, 3-21, 3-26, 3-41, 3-44, 3-46, 3-47, 4-5, 4-6, 4-12, 4-22, 4-28, 4-29, 4-30, 4-31, 4-34, 4-35, 4-36, 4-38, 4-39, 5-18, 5-22, 5-28, 5-42, 5-44, 5-46, 5-50, 5-51
 Inoculation, 4-6, 4-17, 4-34, 4-35, 4-36, 4-38, 4-39
 Intelligence, 1-1, 1-3, 1-5, 2-13, 3-23, 4-1, 4-2, 4-5, 4-20, 5-1, 5-2, 5-16, 5-39, 5-46, 5-47, 7-16, 8-1, 8-3, 8-4, 8-5
 Inversion, 1-8, 4-6, 5-19
 Investigational New Drug, 3-48, 4-27, 4-32, 4-34, 4-39, 7-24
 IOC, 1-4, 3-9, 3-19, 8-2, 8-9
 Iodine, 3-5, 3-6, 3-7, 3-8, 3-15, 3-16, 3-44
 Ionizing Radiation Dosimetry Center, 8-2, 8-9
 Ionizing radiation, 1-7, 2-10, 2-17, 2-19, 2-21, 3-3, 3-31, 3-35, 3-47, 6-22
 IR, see Ionizing radiation
 Irradiance, 6-1, 6-6, 6-10
 Irritants, 1-2, 5-41
 Isolation, 2-34, 3-20, 4-17, 4-18, 4-27, 4-30, 5-18, 5-39, 8-7
 Isotope, 3-5, 3-9, 3-13, 3-15, 3-16, 3-29, 3-31, 3-34, 3-39, 3-41, 3-42, 3-43, 3-45, 3-46, 3-47
 Japanese B encephalitis, 4-28
 Jaundice, 4-2, 4-29, 5-53
 J-FIRE, 7-3, 7-30, 7-31
 JNACC, 8-2, 8-8
 JSLIST, 7-3, 7-30
 Junin, 4-20
 Korean hemorrhagic fever, 4-20, 4-25, 4-29
 Krypton, 3-5, 3-13, 6-8
 Kyanasur Forest disease, 4-27
 L, see Lewisite
 LAAT, 6-8, 6-9
 Labile, 5-40
 Lacrimation, 5-23, 5-37, 5-42
 Lapse, 1-8, 3-36, 5-19
 LASER, 1-3, 1-7, 6-1, 6-2, 6-3, 6-4, 6-5, 6-6, 6-7, 6-8, 6-9, 6-10, 6-11, 6-12, 6-13, 6-14, 6-15, 6-16, 6-18, 6-19, 6-20, 6-21, 6-24, 8-1, 8-2, 8-10
 Lassa fever, 4-21, 4-25, 4-27
 Latent, 2-25, 2-35, 5-24, 5-33, 5-41
 LBO, 6-2, 6-20, 6-21
 LCt50, 5-19, 5-27, 5-41, 5-43
 Lead, 3-13, 3-14, 3-43, 5-10,
 Lens, 2-23, 6-10, 6-12, 6-13, 6-19, 6-20, 6-22, 6-26, 7-28, 7-29
 Lethality, 2-25, 4-16, 4-22, 4-23, 4-24, 4-25, 4-26, 4-38
 Leukopenia, 4-38, 5-34
 Lewisite, 5-13, 5-20, 5-21, 5-22, 5-23, 5-24, 5-25, 5-26, 5-27, 5-32, 5-33, 5-35, 7-14, 7-15, 7-16
 LF, see Low Frequencies
 LLR, 3-22, 3-25
 Low Frequencies, 6-24
 Low Level Radiation Operational Exposure, 3-23, 3-27
 LPL-30, 6-8, 6-9
 LSD, see D-Lysergic Acid Diethylamide
 Lymphadenitis, 4-34
 Lymphocyte, 2-27, 2-28, 2-35
 M11, 3-11, 7-2, 7-26, 7-27
 M13, 7-2, 7-26, 7-27
 M17, 3-11, 7-2, 7-3, 7-26, 7-27, 7-28, 7-29
 M18A2, 7-1, 7-16
 M20A1, 7-3, 7-31
 M21, 7-3, 7-19, 7-22, 7-27
 M22, 7-2, 7-3, 7-20, 7-27
 M256, 1-12, 7-16, 7-18
 M256A1, 1-12, 1-15, 1-16, 7-1, 7-16
 M258, 4-13, 5-15, 7-25
 M258A1, 1-15, 1-16, 4-13, 7-2, 7-17, 7-25, 7-26
 M272, 5-28, 7-1, 7-17
 M28, 7-3, 7-31, 7-32
 M28A1 7-1, 7-4
 M280, 7-2, 7-17, 7-25, 7-26
 M291, 1-15, 4-13, 5-15, 7-2, 7-25, 7-26
 M295, 1-16, 7-2, 7-26
 M31E1, 7-13
 M40, 6-20, 7-3, 7-28
 M42, 6-2, 6-20, 6-21, 7-3, 7-18, 7-28
 M43, 7-29
 M43A1 7-10, 7-18, 7-19
 M45, 7-3, 7-29
 M48/49, 7-3, 7-29
 M4A1, 2-18, 7-4
 M5A2, 2-12
 M8, 1-15, 1-16, 5-11, 5-28, 7-1, 7-14, 7-16, 7-19
 M8A1, 1-15, 3-13, 3-43, 5-28, 7-1, 7-18, 7-20
 M9, 1-15, 3-11, 3-37, 5-28, 7-1, 7-14, 7-16, 7-29
 M90, 7-1, 7-18
 Macrophage, 4-32
 Macular, 4-36
 Magnesium, 3-44, 5-52
 Magnesium, 5-54
 Magnetic Field, 6-25
 Manifest, 2-25, 2-33, 2-34, 2-35,
 Marburg, 4-21, 4-27, 4-29
 Marine Corps, 7-20, 8-1, 8-6
 Mass spectroscopy, 4-17

- Mass spectrometry, 7-2, 7-13, 7-15, 7-19, 7-20
 Maximum Downwind Hazard, 4-9
 MCDM, 7-2, 7-24
 MCU-2A/P, 7-3, 7-29
 MDS, 7-3, 7-27, 7-28
 MEDCOM, 8-1, 8-5
 Mediastinal, 4-18
 Medical Treatment Facility, 1-9, 1-10, 1-14, 3-20, 3-38, 4-13, 4-19, 8-9
 Medium Frequencies, 6-24
 Melena, 4-33
 Melioidosis, 4-7, 4-20, 4-22, 4-29
 Meningitis, 4-31, 4-35
 Meteorological, 2-20, 5-3, 5-18
 Methyl-isocyanate, 5-7
 Metoclopropamide, 2-29
 MF, see Medium Frequencies
 MICAD, 7-1, 7-3
 Microcystins, 4-7, 4-21
 Microorganism, 4-5, 4-9, 4-15, 4-16
 Microwave, 6-22
 Micturition, 5-25
 MILES, 6-8, 6-9
 Mini-CAD, 7-2, 7-15, 7-19, 7-20
 Mini-CAMS, 7-2, 7-20
 Miosis, 5-16, 5-23, 5-30, 5-31
 Mission, 1-4, 1-7, 1-8, 1-9, 1-10, 2-9, 2-11, 2-13, 3-23, 3-24, 3-25, 3-26, 3-28, 3-29, 3-34, 3-37, 5-2, 5-14, 5-50, 6-3, 7-3, 7-11, 7-19, 7-32, 8-4, 8-5, 8-6, 8-7, 8-8, 8-9, 8-10, 8-11
 MMDA, see USAMMDA
 MMS, 6-8, 6-9
 Modeccin, 4-21
 MOPP, 1-1, 1-3, 1-7, 1-8, 1-12, 1-13, 1-14, 1-15, 2-22, 4-4, 4-10, 4-11, 4-12, 5-14
 Mosquito, 4-5, 4-28, 4-30, 4-36, 4-39
 MRICD, see USAMRICD
 MRMC, see USAMRMC
 MSMC, 6-15
 MTF, see Medical Treatment Facility
 Muchupo, 4-20
 Mucous membranes, 4-6, 4-13, 4-28, 4-34, 4-39, 5-18, 5-24, 5-26, 5-32, 5-34, 5-36, 5-51
 Munitions, 1-2, 1-6, 3-2, 3-10, 3-12, 3-15, 3-19, 3-38, 3-46, 3-47, 5-4, 5-7, 5-17, 5-39, 7-21, 8-8
 Muscarinic, 5-29, 5-30
 Mustard, 1-8, 5-8, 5-9, 5-10, 5-12, 5-13, 5-15, 5-20, 5-21, 5-22, 5-26, 5-27, 5-32, 5-33, 5-34, 5-35, 7-14, 7-15, 7-18, 7-21
 Mustard/Lewisite Mixture, 5-20, 5-21, 5-22, 5-23, 5-24, 5-25, 5-26, 5-27
 Myalgia, 4-29, 4-32, 4-34, 4-38, 4-39
 Mycotoxin, see Trichothecene Mycotoxins
 Mydriasis, 5-23
 Myonecrosis, 4-33
 NAAK Mark 1, 7-2, 7-24
 Nairovirus, 4-20
 NAPP, 7-2, 7-24, 7-25
 NATO, 1-7, 1-11, 1-12, 1-17, 2-6, 2-9, 2-11, 3-1, 3-5, 3-21, 3-22, 3-23, 3-28, 3-29, 3-43, 4-14, 5-1, 5-3, 5-45, 5-46, 5-47, 5-48, 7-29, 7-31
 Navy, 4-19, 7-11, 7-13, 7-20, 8-1, 8-6
 NBC Center, 4-8
 NCRP, 3-43, 3-45, 3-48
 NECC, 8-2, 8-11
 Necrosis, 3-47, 4-35, 5-23, 5-52
 Nerve, 1-7, 3-46, 4-1, 4-15, 4-29, 4-30, 4-32, 5-1, 5-2, 5-7, 5-8, 5-9, 5-10, 5-11, 5-12, 5-13, 5-15, 5-16, 5-20, 5-21, 5-28, 5-29, 5-30, 5-31, 5-32, 5-42, 7-2, 7-16, 7-17, 7-18, 7-19, 7-20, 7-21, 7-22, 7-23, 7-24, 7-25, 7-29
 Neurologic, 2-26, 2-28, 2-29, 4-37, 4-39
 Neuropathy, 5-53
 Neurovascular, 2-25
 Neutron, 2-1, 2-17, 2-18, 2-19, 2-20, 3-7, 3-8, 3-13, 3-32, 3-36, 3-39, 3-40, 3-42, 3-43, 3-44, 3-45, 7-4, 7-5, 7-11
 Nickel, 3-6, 3-13, 3-44
 Nitrogen Mustard, 5-20, 5-21, 5-22, 5-23, 5-24, 5-25, 5-26, 5-27, 5-32, 7-14
 Nitrogen tetroxide, 5-7
 NMCC, 8-1, 8-6
 Non-persistent, 5-3, 5-18, 5-28, 5-41, 5-42, 7-16
 NRC, 1-4, 3-10, 3-13, 3-29, 3-30, 3-38, 3-47, 7-18, 8-2, 8-11
 Nuclear reactors, 1-2, 1-6, 3-5, 3-17
 Nuclear weapon, 1-2, 1-6, 2-1, 2-5, 2-6, 2-7, 2-8, 2-9, 2-17, 2-20, 2-21, 2-23, 3-1, 3-3, 3-4, 3-14, 3-15, 3-16, 3-22, 3-44, 7-7, 7-10, 8-5
 Nuclei, 2-20, 4-16
 Nucleus, 2-19, 3-39, 3-40
 Obscurant, 5-50
 Obtundation, 4-36
 O-Chlorobenzylidene Malononitrile, 1-2, 5-20, 5-21, 5-22, 5-23, 5-24, 5-25, 5-26, 5-27, 5-41, 5-42
 Ocular, 4-30, 4-36, 6-3, 6-4, 6-6, 6-9, 6-10, 6-18, 6-24, 6-26
 OEG, 2-11, 3-34, 3-37
 Office of the Surgeon General, 1-10, 2-6, 6-24, 6-26, 8-1, 8-5
 OG-84, 7-3, 7-30
 Oliguria, 5-53
 OOTW, see Operations Other Than War
 Operation Joint Endeavor, 1-5
 Operational data, 4-1, 4-19, 4-20, 4-22, 4-23, 4-24, 4-25
 Operations Other Than War, 3-22, 3-23, 3-25, 5-43
 Ordnance, 1-4
 Orthopnea, 5-38
 Orthopoxvirus, 4-21
 Osteomyelitis, 4-32

- Overgarment, 1-12, 1-13, 1-14, 1-15, 1-16, 5-28, 5-33, 5-39, 7-3, 7-28, 7-29, 7-30
- Overprotection, 4-12
- Oximes, 5-22, 5-32, 5-33
- Pallor, 5-23
- Palytoxin, 4-21, 4-24
- Paralytic Shellfish Poisoning, see Saxitoxin
- Pathogenicity, 4-16
- Patient protective wrap (PPW), 7-3, 7-31
- PCPS, 7-3, 7-32
- PCR, see Polymerase Chain Reaction
- PDR-77, see AN/PDR-77
- PEL, 6-25, 6-26
- Percutaneous, 4-6, 5-14
- Persistence, 4-8, 4-22, 4-23, 4-24, 4-25, 4-26, 5-2, 5-18, 5-21, 5-28, 5-33
- Persistent, 1-2, 3-20, 3-46, 5-3, 5-7, 5-18, 5-20, 5-28, 5-32, 5-36, 5-41, 6-11
- Petechiae, 4-29, 4-33, 4-36
- Phenargen, 5-22
- Phlebovirus, 4-21, 4-28
- Phosgene oxime, 5-13, 5-20, 5-21, 5-22, 5-23, 5-24, 5-25, 5-26, 5-27, 5-32, 5-33, 5-35, 7-14
- Phosgene, 5-7, 5-13, 5-20, 5-21, 5-22, 5-23, 5-24, 5-25, 5-26, 5-27, 5-33, 5-35, 5-37, 5-38, 5-44, 5-52, 7-14, 7-15
- Phosphorus, 1-2, 5-12, 5-44, 5-51, 5-52, 7-21
- Photophobia, 4-31, 4-39, 5-23
- Picloram, 5-54
- Plague, 4-5, 4-7, 4-20, 4-22, 4-27, 4-28, 4-29, 4-30, 4-34, 4-35, 7-11
- Plasma radiation, 6-7
- Pleural, 4-18, 4-31, 5-24, 5-35
- Plutonium, 2-20, 2-21, 3-4, 3-7, 3-13, 3-19, 3-21, 3-40, 3-41, 3-42, 3-44, 7-7
- Pneumonia, 4-2, 4-5, 4-29, 4-34, 4-35, 4-39, 5-24, 5-51
- Pneumonic, 4-5, 4-22, 4-28, 4-30, 4-34, 4-35, 4-39
- Pocket Dosimeters, 3-36
- Polymerase Chain Reaction, 4-18, 4-30, 7-1, 7-11, 7-12
- Portal shield, 1-10
- Power density, 6-5, 6-6, 6-10, 6-25
- PP-4276/PD, 7-4
- Prodromal, 2-25, 2-27, 2-29, 2-33, 2-35
- Prodrome, 4-37
- Prophylaxis, 4-9, 4-10, 4-16, 4-27, 4-31, 4-32, 4-33, 4-34, 4-35, 4-36, 4-37, 4-38, 4-40
- Prostration, 4-33, 4-39, 5-25, 5-34
- Protective mask, 1-7, 1-12, 1-14, 1-15, 3-19, 4-13, 5-17, 5-25, 5-34, 5-36, 5-38, 5-39, 5-42, 5-50, 7-3, 7-16, 7-25, 7-26, 7-28, 7-29, 7-30, 7-32
- Protective posture, 4-4, 4-12, 4-14, 5-48, 7-17
- PS, Chloropicrin
- Pseudomonas pseudomallei*, see Melioidosis
- Psittacosis, 4-7, 4-20, 4-23, 4-29
- PSP, see Saxitoxin
- Psychological, 3-4, 3-22, 3-27, 5-16, 6-3, 6-10, 6-13, 6-22, 6-23
- Ptoxis, 4-30, 4-31
- Public Affairs Guidance, 8-3, 8-12
- Pustule, 4-37
- Pyridostigmine bromide, 7-24
- Q fever, 4-7, 4-15, 4-20, 4-23, 4-27, 4-29, 4-28, 4-30, 4-35
- Quarantine, 1-17, 4-37
- Radar, 2-10, 6-24, 6-25
- RADCON, 3-3, 8-2, 8-8
- RADIAC, 2-7, 3-14, 3-46, 7-1, 7-4, 7-6, 7-7, 7-11
- Radiation Exposure States, 2-1, 2-11, 2-12, 3-23, 3-25, 3-26, 3-27, 3-28, 3-37, 3-38
- Radiation protection, 2-1, 2-14, 2-15, 3-30, 3-38
- Radiation safety, 3-9, 8-2, 8-9
- Radio, 6-24, 7-18
- Radioactivity, 3-4, 3-5, 3-6, 3-28, 3-38, 3-42
- Radiofrequency, 1-3, 1-7, 6-1, 6-2, 6-22, 6-23, 6-24, 6-25, 6-26, 8-10 8-1, 8-2, 8-4, 8-7, 8-8
- Radiological hazard, 1-2, 1-6, 1-7, 2-8, 2-13, 3-1, 3-3, 3-5, 3-6, 3-7, 3-17, 3-21, 3-22, 3-23, 3-24, 3-25, 3-26, 3-43, 8-8
- Radionuclide, 3-2, 3-6, 3-15, 3-16, 3-28, 3-30, 3-39, 7-10
- Radiosensitivity, 2-1, 2-2, 2-23, 2-24
- Radium, 3-4, 3-7, 3-8, 3-13, 3-14, 3-15, 3-38, 3-45, 7-10
- Rales, 5-24
- RAMT, 8-2, 8-9
- Rangefinders, 6-6, 6-10, 6-18
- REAC, 8-2, 8-11
- Red Cross, 6-1, 6-4
- Releases Other than Attack, 3-2, 3-16, 3-17, 3-24, 3-25, 5-1, 5-3, 5-7, 5-47, 5-48, 5-49
- RES, see Radiation Exposure States
- Respirator, 4-11, 5-10, 5-32, 5-46, 5-48, 5-50, 5-51, 5-52
- Retina, 2-22, 2-23, 6-3, 6-10, 6-11, 6-12, 6-13
- Retinal Injuries/damage, 6-3, 6-11, 6-13, 6-14, 6-15
- Retrosternal, 4-38
- Retrosternal, 5-43
- Reverse osmosis, 5-10
- RF, see Radiofrequency
- Rhinorrhea, 4-30, 5-24, 5-30
- Ribavirin, 4-27, 4-33, 4-34, 4-36
- Ricin, 4-7, 4-21, 4-24, 4-27, 4-28, 4-29, 4-35, 7-11
- Rickettsia*, 4-1, 4-7, 4-16, 4-20, 4-23, 4-28, 4-35
- Rickettsia prowazekii*, see Endemic Typhus
- Rickettsia rickettsii*, see Rocky Mountain Spotted Fever
- Rickettsia tsutsugamushi*, see Scrub Typhus
- Rift Valley Fever, 4-7, 4-21, 4-26, 4-27, 4-28, 4-29, 4-35, 4-36
- Rigors, 4-34, 4-37

- RIID, see USAMRIID
- Riot control agents, 5-11, 5-38, 5-41
- Risk, 1-4, 1-9, 1-10, 1-14, 1-17, 2-1, 2-2, 2-4, 2-11, 2-12, 2-27, 3-1, 3-3, 3-21, 3-22, 3-23, 3-25, 3-27, 3-28, 3-32, 3-48, 4-1, 4-2, 4-3, 4-14, 4-18, 4-19, 4-34, 5-2, 5-6, 5-13, 5-14, 5-15, 5-19, 5-23, 5-24, 5-45, 5-46, 5-47, 5-50, 8-4, 8-11
- Rocky Mountain Spotted Fever, 4-20, 4-23, 4-28, 4-29
- ROTA, see Releases Other than Attack
- ROWPU, see Reverse osmosis
- RPO, 3-9, 3-18
- RSCAAL, 5-28, 7-2, 7-15, 7-19, 7-22
- RSO, 3-9, 3-18, 3-19
- Russian spring-summer encephalitis, 4-21, 4-26, 4-28, 4-29
- RVF, see Rift Valley Fever
- S2/G2, 1-3, 1-5
- S2/S3, 1-3, 2-6
- S5/G5, 1-4, 1-5
- Sabotage, 4-6, 4-22, 4-23, 4-24, 4-27
- Salmonella*, 4-7, 4-20
- Salmonella enteritidis*, see Salmonellosis
- Salmonella typhi*, see Typhoid Fever
- Salmonella typhimurium*, see Salmonellosis
- Salmonellosis, 4-20, 4-29
- Sanitation, 2-15, 4-10, 4-11, 4-12
- Saratoga, 7-3, 7-30
- Sarin, 3-46, 5-12, 5-15, 5-20, 5-21, 5-22, 5-23, 5-24, 5-25, 5-26, 5-27, 5-28, 7-14, 7-15, 7-21
- Saxitoxin, 4-7, 4-21, 4-24, 4-29, 4-36, 4-37
- SBCCOM, 1-12, 8-1, 8-3, 8-6, 8-7
- SCBA, see Self-Contained Breathing Apparatus
- Scintillation, 3-18, 3-32, 3-46, 7-4, 7-5, 7-7, 7-8, 8-8
- Sclera, 6-12
- Scotoma, 6-11
- SCPE, 7-3, 7-31, 7-32
- Scrub Typhus, 4-20
- SEB, see Staphylococcal enterotoxin B
- Secretary of Defense, 7-24, 8-2, 8-8
- SELF-AID, 1-7, 1-9
- Self-Contained Breathing Apparatus, 5-48
- Septicemic, 4-34, 4-39
- Sequelae, 4-36, 5-38
- SHF, see Super High Frequencies
- Shielding, 2-1, 2-14, 2-15, 2-24, 2-35, 3-14, 3-40
- Shigella*, 4-20, 4-29
- Shigellosis, 4-7, 4-20, 4-29
- Smallpox, 1-17, 4-21, 4-26, 4-27, 4-28, 4-29, 4-30, 4-37
- Smoke, 3-43, 5-16, 5-26, 5-37, 5-41, 5-42, 5-43, 5-50, 5-51, 6-19, 7-17, 7-27
- Snellen chart, 6-14
- Sodium, 2-21, 3-8, 3-16, 3-48, 4-13, 4-36, 4-37, 5-10, 5-12, 5-14, 5-23, 5-42, 5-43, 7-23
- Sodium hypochlorite, 4-13, 4-37
- Soman, 5-12, 5-15, 5-20, 5-21, 5-22, 5-23, 5-24, 5-25, 5-26, 5-27, 5-28, 5-29, 7-15, 7-24, 7-25
- SOP, 1-10, 3-37
- Sorbent, 7-3, 7-21, 7-28
- Sore throat, 4-2, 4-29, 4-31, 4-37, 4-39
- Special Forces, 1-4
- Specimen, 3-38, 4-17, 4-18, 4-19, 4-20
- SPECS, 6-2, 6-19, 6-21
- Spore, 4-17
- SSCOM, 6-18
- Stability, 1-2, 1-3, 4-16, 4-28, 5-19, 7-28
- STANAG 2002, 3-21, 3-24, 5-45, 5-49
- STANAG 2083, 2-9, 2-11, 3-21, 3-48
- STANAG 2103, 3-21, 5-45
- STANAG 2112, 3-21, 3-24, 5-45
- STANAG 2150, 3-21, 5-45
- STANAG 2352, 3-21, 5-45
- Staphylococcal enterotoxin B, 4-21, 4-24, 4-28, 4-29, 4-30, 4-37, 4-38, 7-11
- Staphylococcus aureus*, see Staphylococcal enterotoxin B
- STB, 1-15, 4-13, 5-15, 7-25, 7-27
- Stockpile, 8-5
- STP 21-1-SMCT, 1-2, 1-7
- Stress, 1-8, 4-10, 5-18, 6-13, 6-24, 6-25
- Stridor, 4-31, 4-34
- Strontium, 3-5, 3-7, 3-13, 3-15, 3-16, 3-41, 3-43, 3-45
- Subretinal hemorrhage, 6-11, 6-15
- Sulfur dioxide, 5-7, 5-44
- Sulfur Mustard, 5-1, 5-20, 5-21, 5-22, 5-23, 5-24, 5-25, 5-26, 5-27, 5-32, 5-52, 7-14, 7-15, 7-16, 7-21
- Sulfur trioxide, 5-7
- Super High Frequencies, 6-22, 6-24, 6-25
- Superchlorination, 5-10
- Surveillance, 1-4, 1-9, 1-10, 4-2, 4-10, 4-36, 6-13, 6-22, 6-24, 7-19, 8-6
- Surveys, 3-1, 3-15, 3-32, 3-33, 3-34
- Symptomatic treatment, 4-27, 5-39
- Symptoms, 1-2, 1-3, 1-9, 1-12, 2-9, 2-11, 2-24, 2-25, 2-26, 2-27, 2-28, 2-29, 2-30, 2-33, 2-35, 3-46, 4-2, 4-4, 4-5, 4-6, 4-13, 4-15, 4-16, 4-17, 4-18, 4-19, 4-22, 4-23, 4-24, 4-26, 4-27, 4-31, 4-35, 4-37, 4-38, 5-2, 5-14, 5-16, 5-17, 5-18, 5-21, 5-22, 5-23, 5-24, 5-29, 5-31, 5-32, 5-33, 5-34, 5-35, 5-36, 5-37, 5-38, 5-39, 5-40, 5-41, 5-42, 5-43, 5-51, 5-53, 6-1, 6-2, 6-10, 6-13, 6-14, 6-15, 6-23, 6-24, 6-25, 6-26, 7-24, 8-10
- Synapses, 4-31, 5-38
- T-2 Mycotoxin, see Trichothecene mycotoxins
- Tabun, 5-12, 5-20, 5-21, 5-22, 5-23, 5-24, 5-25, 5-26, 5-27, 5-28, 7-14, 7-15, 7-24
- Tachycardia, 5-18, 5-22, 5-32, 5-40
- TAML, 1-4, 1-10, 3-3, 4-17, 4-18, 4-19, 4-20, 7-12, 7-20, 7-25, 8-1, 8-6
- Tech Escort, 1-11, 4-19, 7-16, 7-20t, 8-2, 8-7

- TEMPER, 7-31, 7-32
- Temperature, 1-8, 2-26, 3-45, 4-7, 4-16, 4-19, 4-27, 4-31, 4-32, 5-3, 5-19, 5-26, 5-28, 5-33, 5-40, 5-44, 6-22, 6-23, 6-25, 7-5, 7-12, 7-24, 7-27, 7-30
- Tenesmus, 5-24
- Terrain, 1-2, 1-3, 1-8, 2-14, 2-21, 3-4, 3-34, 4-14, 5-20, 5-32
- TESTMATE, 7-2, 7-25
- Tetanus, 4-21
- Tetrodotoxin, 4-7, 4-21, 4-24, 4-29
- TH, see Thermite
- Thermal, 2-1, 2-2, 2-3, 2-17, 2-18, 2-19, 2-20, 2-21, 2-22, 2-23, 3-2, 3-12, 3-13, 3-15, 3-39, 5-51, 5-52, 6-11, 6-13, 6-20, 6-22, 6-23, 6-24, 6-25, 6-26, 7-12, 7-30
- Thermite, 5-52
- Thorium, 3-7, 3-12, 3-13, 3-44, 3-45, 7-7, 7-10
- Thrombocytopenia, 4-33
- Thrombosis, 4-34
- Tick(s), 4-5, 4-6, 4-28, 4-33, 4-39
- TICs, see Toxic Industrial Chemicals
- TIMs, see Toxic Industrial Materials
- TLD, 3-35, 3-36
- Toxic Industrial Chemicals, 1-3, 1-5, 1-6, 1-12, 5-1, 5-2, 5-3, 5-7, 5-43, 5-44, 5-45, 5-46, 5-47, 5-48, 5-49, 5-50
- Toxic Industrial Materials, 1-3, 1-10, 1-11
- Toxicity, 3-28, 3-47, 4-16, 4-17, 4-35, 5-19, 5-27, 5-35, 5-36, 5-41, 5-44, 5-46, 5-51, 5-54
- Toxin(s), 4-1, 4-5, 4-6, 4-7, 4-8, 4-9, 4-13, 4-14, 4-15, 4-16, 4-17, 4-20, 4-21, 4-22, 4-23, 4-24, 4-26, 4-27, 4-28, 4-29, 4-30, 4-31, 4-32, 4-33, 4-35, 4-37, 4-38, 5-15, 7-11, 7-29, 7-30
- Transcutaneous, 3-42
- Transmissibility, 4-16, 4-22, 4-23, 4-24, 4-25, 4-26
- Transmission, 2-15, 4-5, 4-14, 4-16, 4-33, 4-34, 5-38, 6-23, 6-24
- Treatment, 1-2, 1-7, 1-9, 1-10, 1-11, 1-12, 1-14, 1-17, 2-1, 2-6, 2-7, 2-9, 2-13, 2-21, 2-23, 2-24, 2-27, 2-28, 2-29, 2-32, 3-8, 3-42, 3-43, 3-44, 3-46, 3-48, 4-9, 4-10, 4-11, 4-12, 4-13, 4-14, 4-16, 4-20, 4-27, 4-31, 4-32, 4-34, 4-35, 5-4, 5-18, 5-22, 5-29, 5-32, 5-35, 5-36, 5-37, 5-38, 5-39, 5-40, 5-41, 5-42, 5-43, 5-51, 5-52, 5-53, 6-1, 6-2, 6-3, 6-13, 6-14, 6-15, 6-26, 7-2, 7-23, 7-24, 7-32, 8-9, 8-10, 8-11
- Triage, 1-11, 2-2, 2-9, 2-27, 2-28, 2-29, 4-13, 4-14, 5-39, 7-5
- Trichothecene mycotoxins, 4-7, 4-21, 4-24, 4-27, 4-28, 4-29, 4-38
- Tritium, 1-4, 3-2, 3-5, 3-6, 3-7, 3-8, 3-9, 3-10, 3-11, 3-14, 3-15, 3-18, 3-19, 3-38, 3-39, 3-42, 3-45, 3-46, 7-10
- Tularemia, 4-7, 4-15, 4-20, 4-22, 4-27, 4-28, 4-29, 4-30, 4-38, 4-39, 7-11
- Type A, 5-3, 5-47, 6-4
- Type B, 5-3, 6-4
- Typhoid fever, 4-20, 4-22, 4-28
- Typhus, 4-7, 4-20, 4-23, 4-28, 4-29
- UHF, see Ultra High Frequencies
- Ultra High Frequencies, 6-24
- Ultrasound, 6-22
- Ultraviolet, 3-35, 6-3, 6-5, 6-6, 6-8, 6-10, 6-12, 7-5
- Uranium, 2-20, 2-21, 3-4, 3-5, 3-7, 3-10, 3-13, 3-19, 3-21, 3-28, 3-29, 3-39, 3-40, 3-44, 3-45, 3-46, 3-47, 8-
- USACHPPM, 1-4, 1-7, 1-9, 1-10, 1-12, 3-3, 3-4, 3-6, 3-7, 3-9, 3-15, 3-17, 3-18, 3-20, 3-32, 3-38, 3-43, 3-48, 4-7, 4-10, 4-18, 4-21, 5-18, 5-19, 5-20, 5-21, 5-26, 5-27, 5-43, 5-44, 6-2, 6-6, 6-8, 6-9, 6-22, 6-26, 8-1, 8-4
- USAIRDC, 3-36, 3-38, 8-2, 8-9
- USAMMDA, 8-1, 8-6
- USAMRICD, 1-7, 1-10, 5-18, 5-28, 5-32, 5-36, 5-37, 5-38, 5-41, 8-2, 8-9, 8-10
- USAMRIID, 1-7, 4-2, 4-8, 4-15, 4-17, 4-18, 4-20, 4-27, 4-31, 4-32, 7-11, 7-12, 8-2, 8-10
- USAMRMC, 4-8, 4-12, 4-31
- USANCA, 3-16, 8-1, 8-5
- UV, see Ultraviolet
- Vaccination, 4-12, 4-15, 4-22, 4-23, 4-24, 4-25, 4-26, 4-27, 4-33, 4-35, 4-37
- Vaccine, 4-12, 4-27, 4-31, 4-32, 4-33, 4-34, 4-35, 4-36, 4-37, 4-38, 4-39, 4-40
- Vapor, 1-12, 1-14, 3-19, 3-46, 4-30, 5-3, 5-8, 5-9, 5-10, 5-11, 5-12, 5-13, 5-15, 5-18, 5-19, 5-26, 5-27, 5-28, 5-29, 5-30, 5-31, 5-33, 5-35, 5-42, 5-46, 5-50, 5-51, 6-8, 7-14, 7-15, 7-16, 7-17, 7-18, 7-19, 7-20, 7-21, 7-22, 7-29, 7-30, 7-31, 7-32
- Variola, 4-7
- Vector(s), 1-4, 4-5, 4-6, 4-10, 4-12, 4-15, 4-16, 4-22, 4-23, 4-26, 4-28, 4-34, 4-36, 4-39
- VEE, see Venezuelan equine encephalitis
- Venezuelan equine encephalitis, 4-5, 4-21, 4-26, 4-27, 4-28, 4-39, 7-11
- Very High Frequencies, 6-24
- Very Low Frequencies, 6-24
- Vesicant, 5-22, 5-33, 5-35, 7-21
- VHF, see Very High Frequencies
- Viremic, 4-33, 4-39
- Virulence, 4-16, 4-32
- Virus(es), 4-1, 4-16, 4-17, 4-18, 4-20, 4-21, 4-25, 4-28, 4-33, 4-36, 4-37, 4-39
- Visible Light, 6-8, 6-12
- Vision, 3-45, 4-30, 4-31, 5-17, 5-23, 5-32, 5-40, 5-50, 6-2, 6-3, 6-10, 6-11, 6-13, 6-14, 6-15, 6-16, 6-17, 6-18, 6-24, 7-22, 7-24, 7-29
- Vitreous, 6-11
- Vitrectomy, 6-11, 6-13
- Vitreous, 6-3, 6-11, 6-13, 6-15
- VLF, see Very Low Frequencies
- Volatility, 5-27, 5-28, 5-52

Vomiting, 2-11, 2-25, 2-26, 2-27, 2-28, 2-30, 2-32, 4-32, 4-33, 4-35, 4-38, 4-39, 5-1, 5-14, 5-20, 5-22, 5-24, 5-29, 5-32, 5-34, 5-40, 5-41, 5-42, 5-43, 5-53, 7-24

Vulnerability, 1-3, 2-1, 2-7, 2-16, 4-1, 4-2, 4-4, 5-2, 6-20

VX, 5-12, 5-15, 5-20, 5-21, 5-22, 5-23, 5-24, 5-25, 5-26, 5-27, 5-28, 7-14, 7-15, 7-21

Vx, 5-21, 5-26, 5-27, 5-28

Water, 1-4, 1-10, 1-13, 2-7, 2-15, 2-17, 2-20, 3-5, 3-6, 3-13, 3-15, 3-18, 3-19, 3-20, 3-21, 3-26, 3-32, 3-40, 3-42, 3-46, 4-1, 4-5, 4-6, 4-7, 4-9, 4-10, 4-11, 4-12, 4-13, 4-17, 4-18, 4-21, 4-22, 4-24, 4-25, 4-32, 4-33, 4-36, 4-38, 4-39, 5-1, 5-2, 5-4, 5-8, 5-9, 5-10, 5-11, 5-12, 5-13, 5-14, 5-15, 5-18, 5-19, 5-26, 5-28, 5-33, 5-34, 5-36, 5-37, 5-39, 5-40, 5-41, 5-42, 5-43, 5-44, 5-49, 5-50, 5-51, 5-52, 5-54, 6-22, 6-25, 6-26, 7-1, 7-2, 7-12, 7-14, 7-17, 7-21, 7-22, 7-25, 7-27, 7-28

Wavelength, 1-3, 6-1, 6-2, 6-5, 6-6, 6-7, 6-8, 6-9, 6-10, 6-11, 6-12, 6-18, 6-19, 6-20, 6-23, 6-25

Weather, 1-3, 1-8, 1-13, 2-6, 2-8, 4-8, 5-47, 7-22

WEE, see Western equine encephalitis

Western equine encephalitis, 4-21, 4-26, 4-29

WHO, 4-33

Wind, 1-8, 1-17, 2-6, 2-12, 2-20, 2-21, 3-17, 3-18, 4-5, 4-8, 5-3, 5-14, 5-19, 6-2, 6-19, 6-20, 6-21

Wounds, 1-14, 2-32, 2-35, 3-20, 3-32, 3-41, 3-47, 4-13, 5-13, 5-15, 6-13

WP, see Phosphorus

WRAIR, 4-20, 6-2, 8-2, 8-10

WRAMC, 8-1, 8-6

XM22, 7-15

X-Ray, 3-1, 3-7, 3-8, 3-9, 3-25, 3-44, 3-45, 3-46, 3-48, 7-6, 7-7, 7-8, 7-9, 7-10

YAG, 6-8

Yellow fever, 4-15, 4-21, 4-26, 4-27, 4-28, 4-29

Yellow Rain, see Trichothecene Mycotoxins

Yersinia pestis, see Plague

Zoonotic, 4-31, 4-32, 4-34, 4-35, 4-3

This page left intentionally blank.